

ABS <w/ VSC , Except TMC Made> , TRAC <Except TMC Made> , VSC <Except TMC Made>

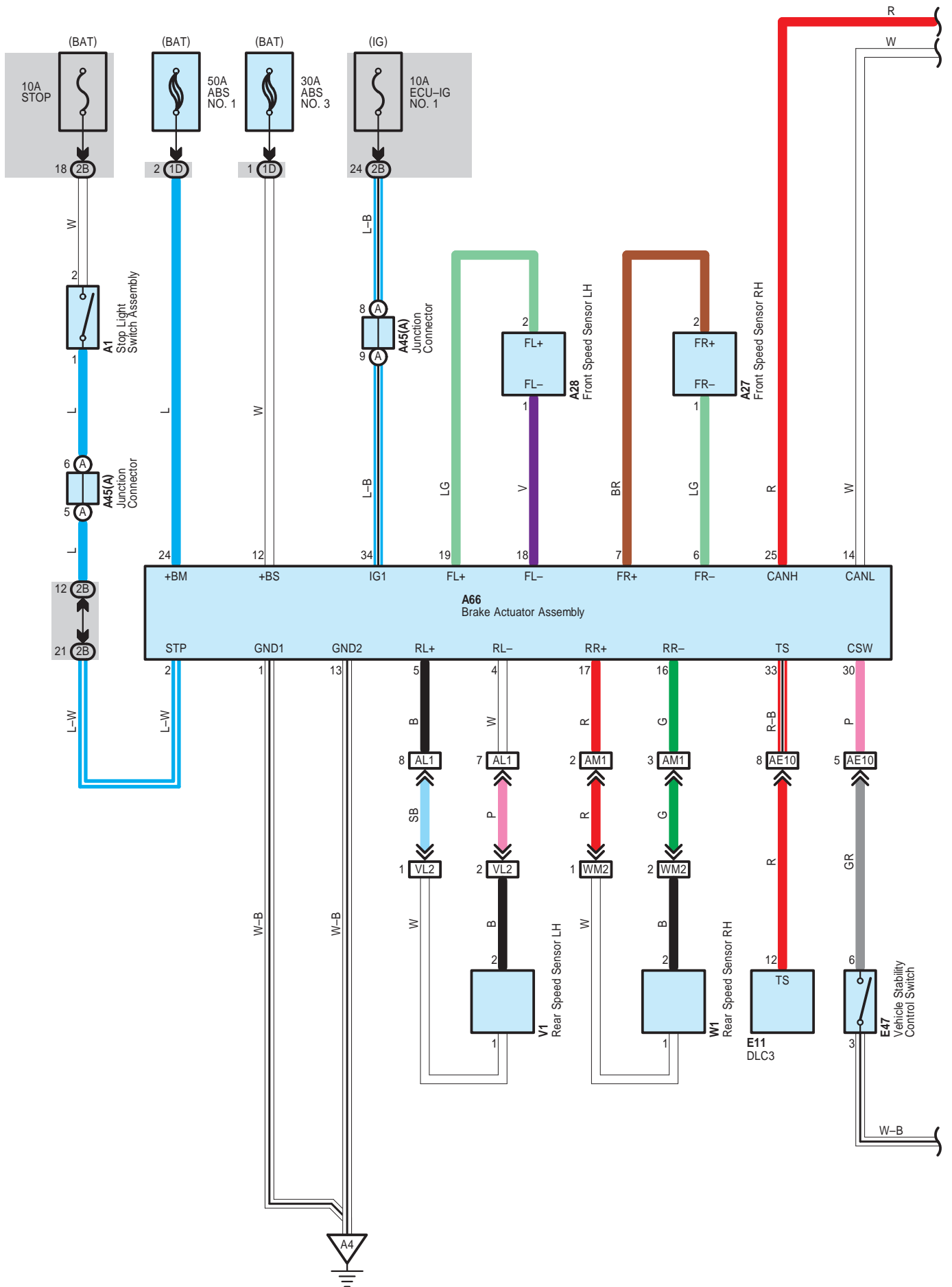

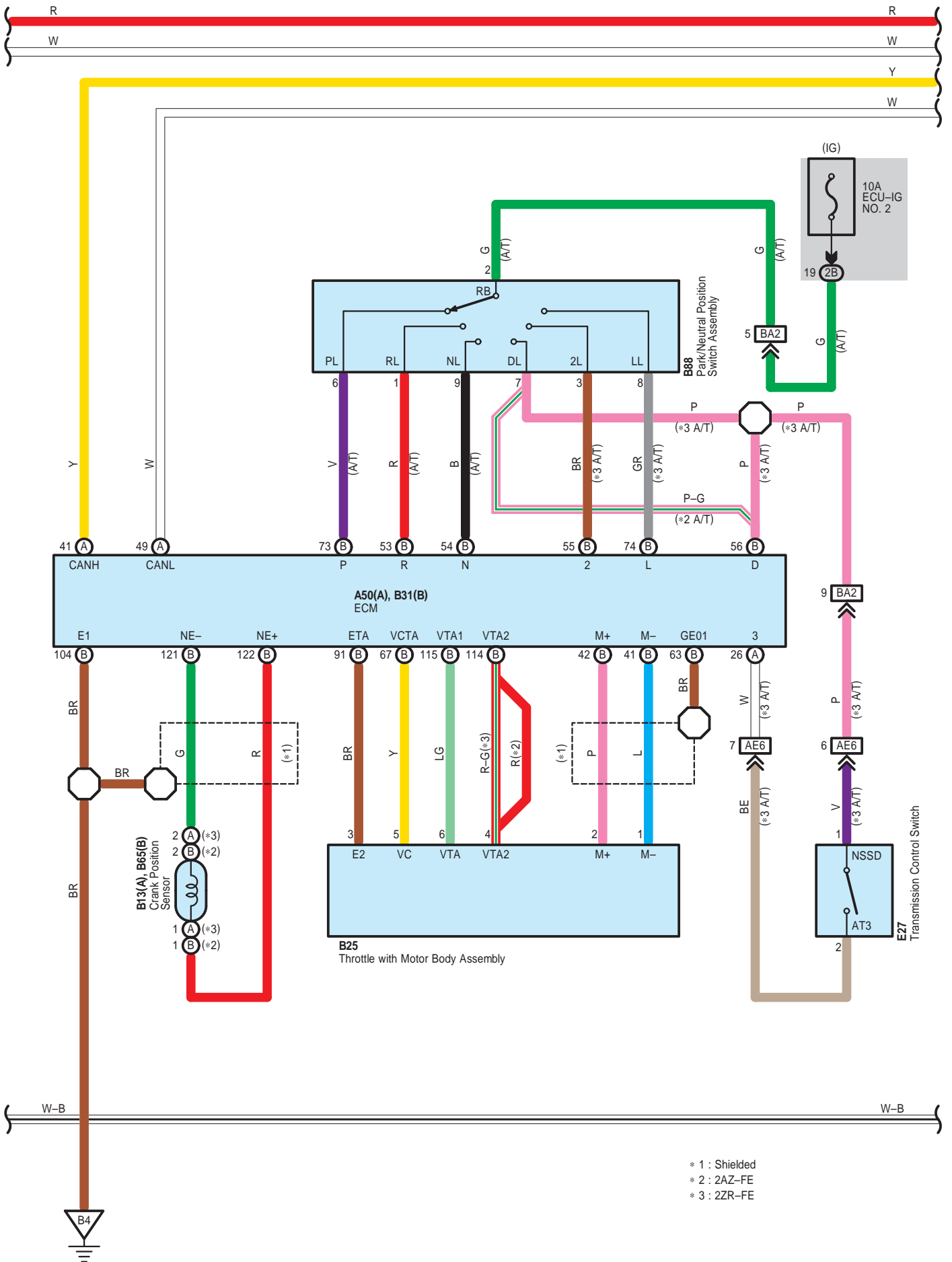

\* 1 : Shielded  
 \* 2 : 2AZ-FE  
 \* 3 : 2ZR-FE

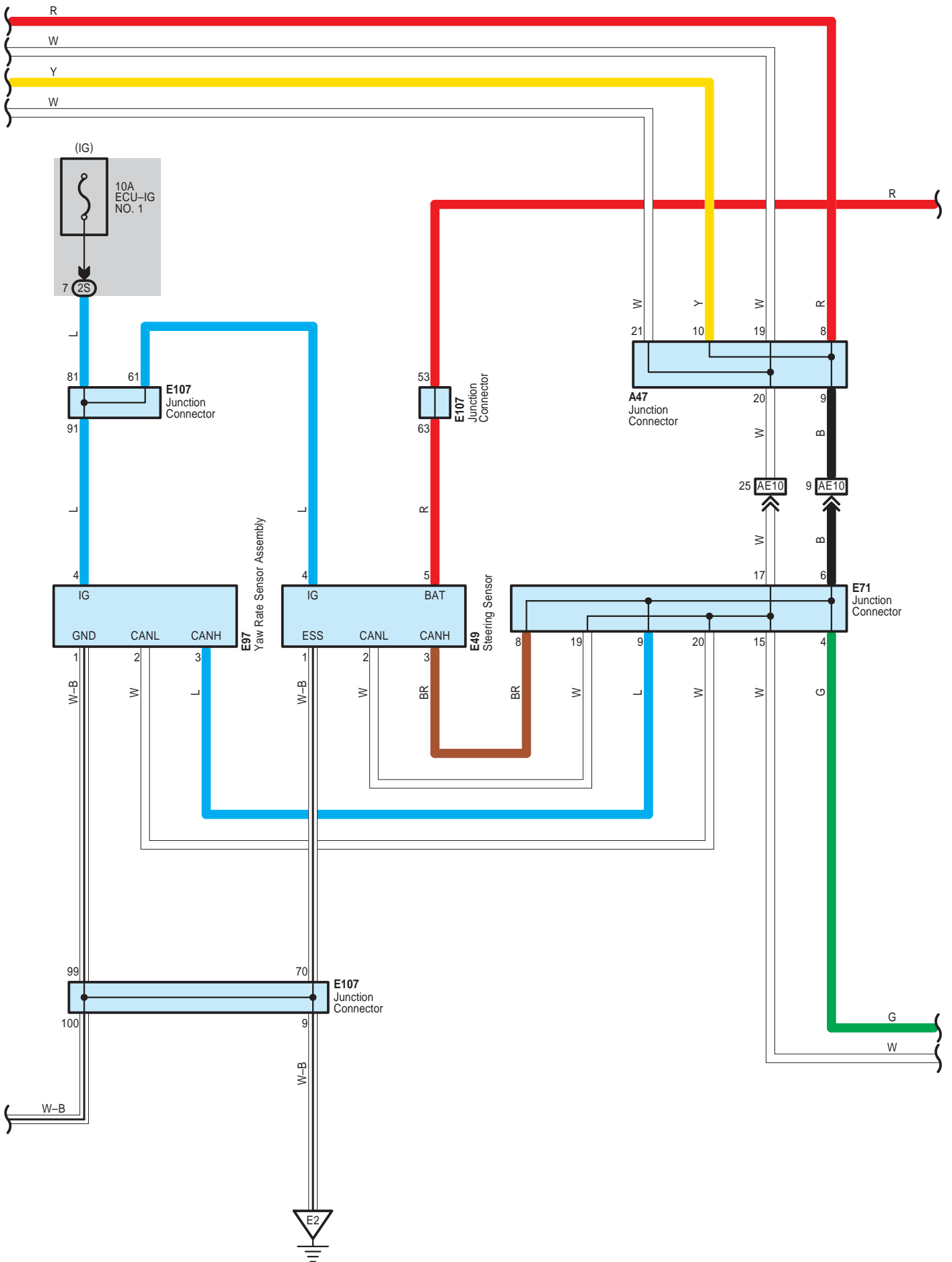

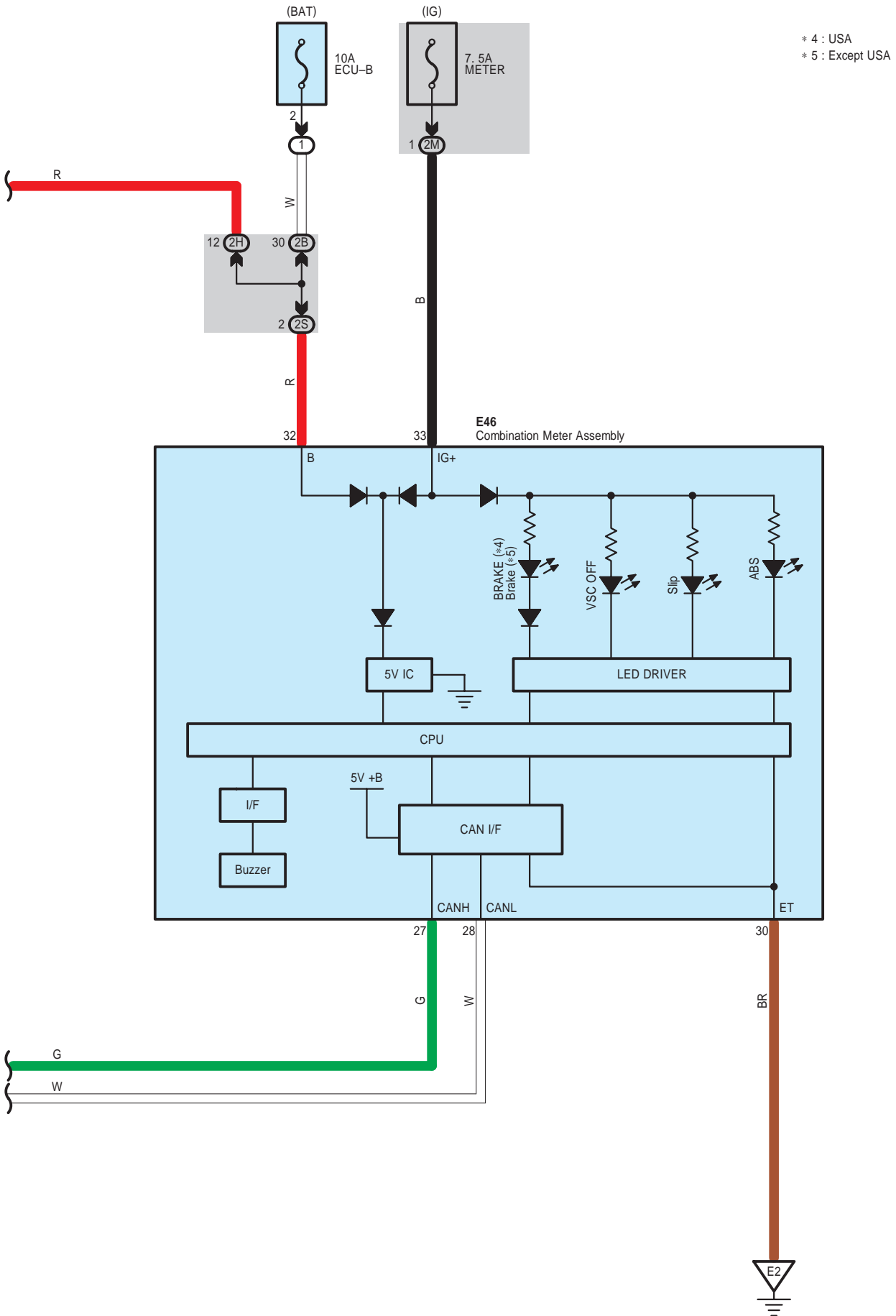

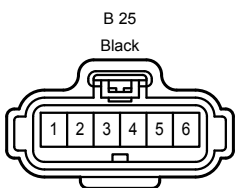
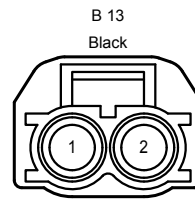
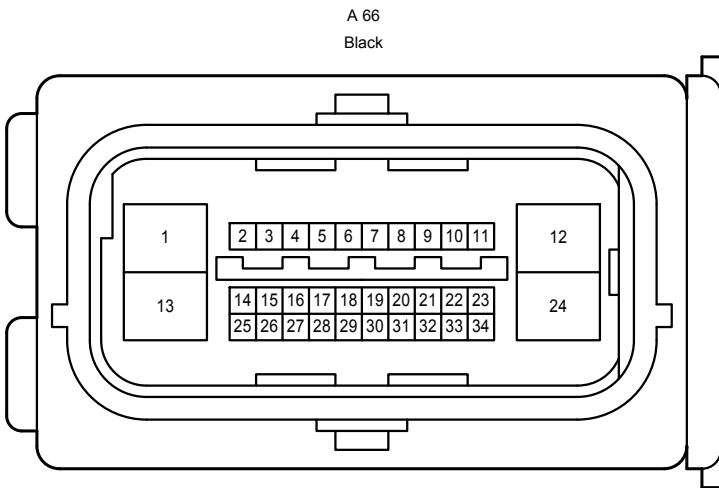
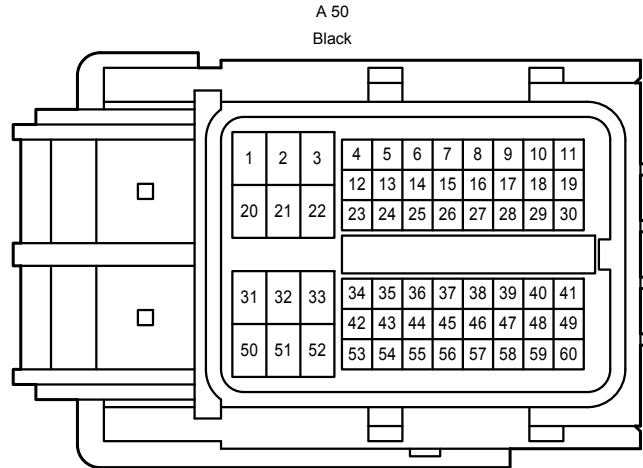
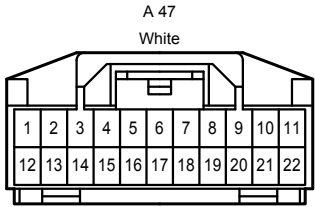
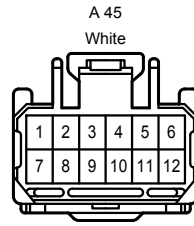
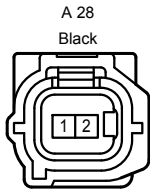
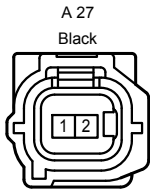
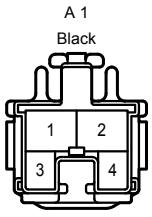

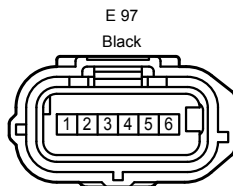
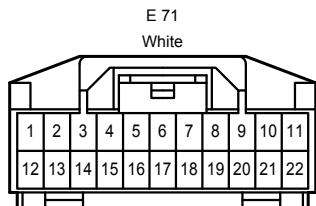
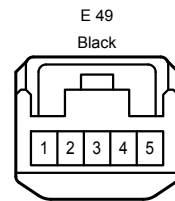
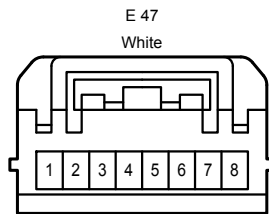
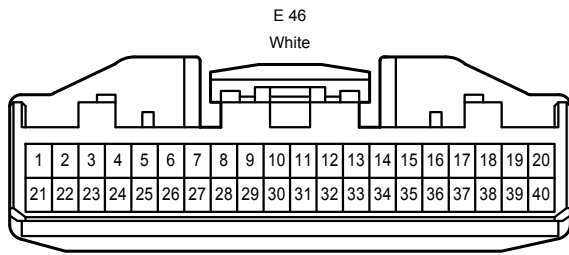
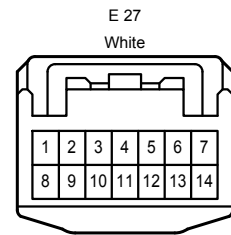
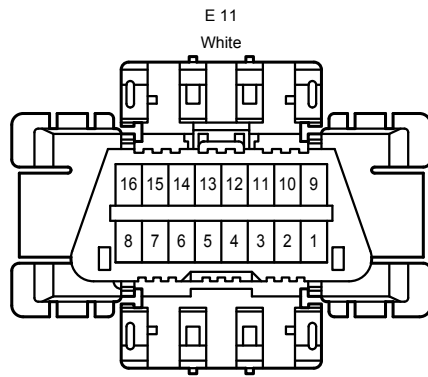
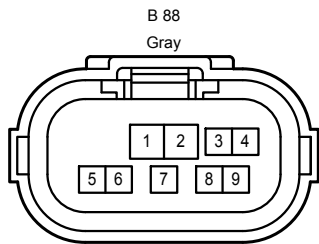
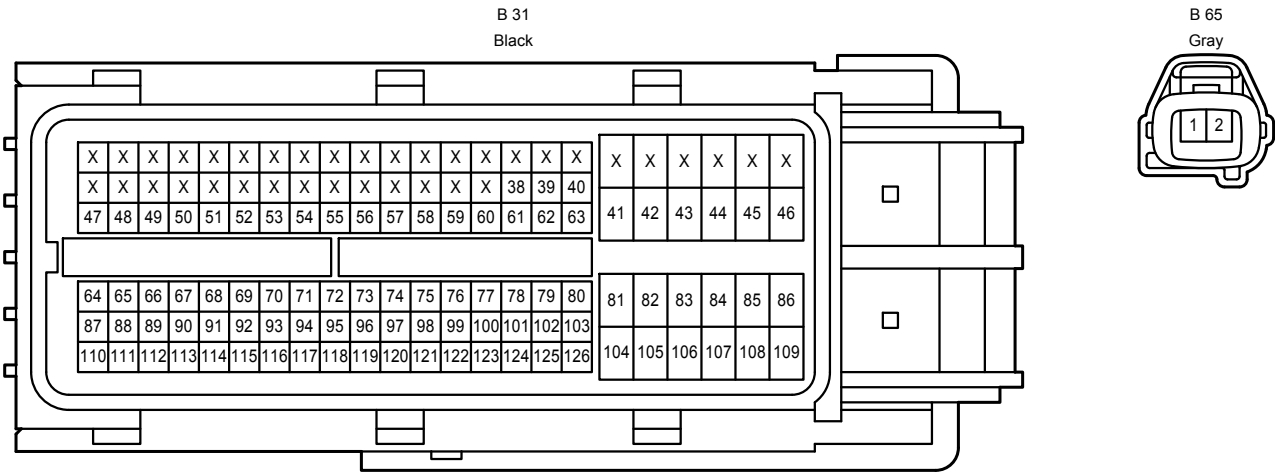

E107  
White

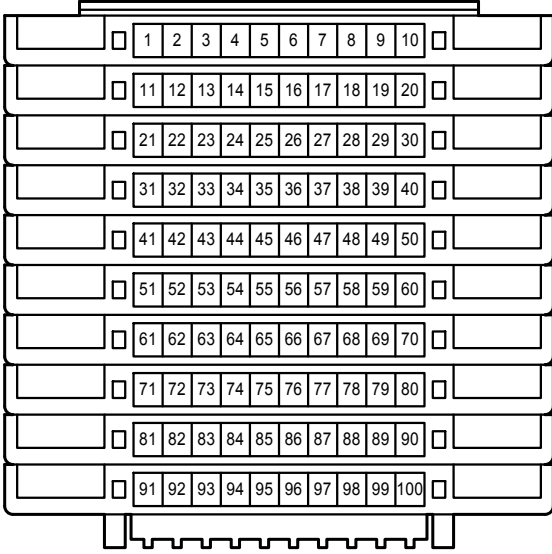

V 1  
Black



W 1  
Black



1D  
White

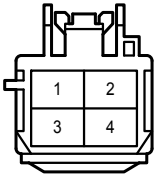

2B  
White

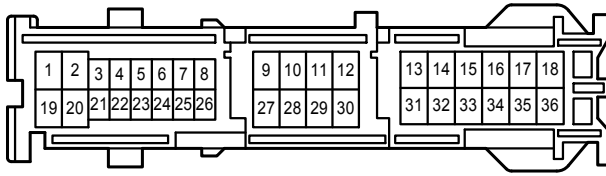

2H  
White

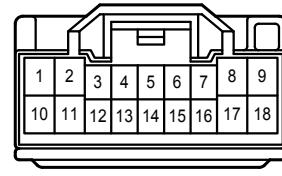

2M  
White

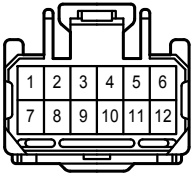

2S  
White

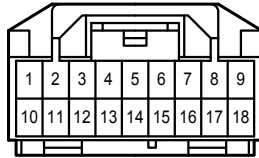

AE6  
Gray

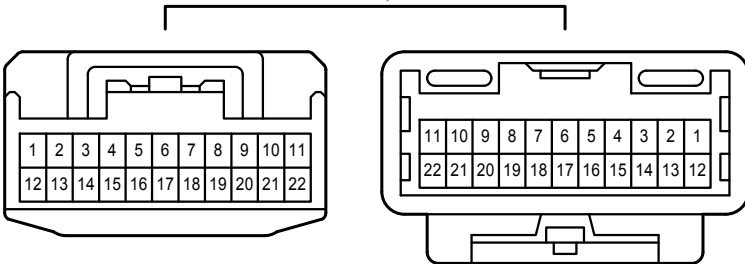

AE10  
Gray

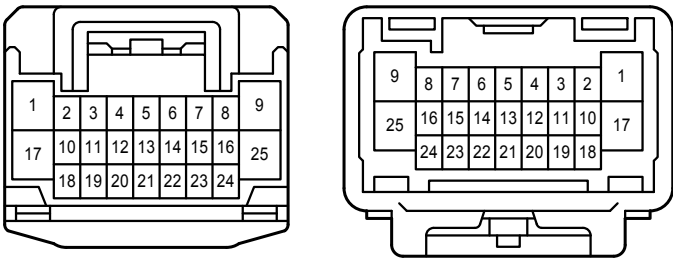

AL1  
White

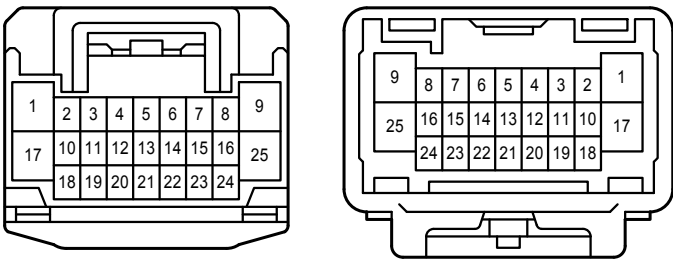

AM1  
White

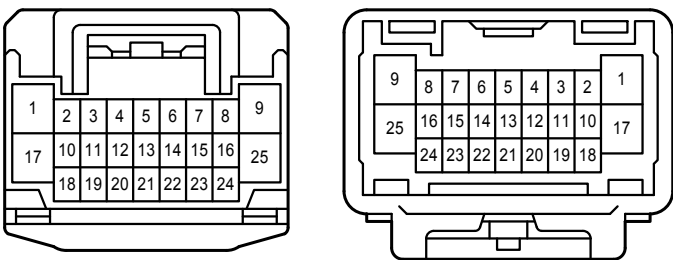

BA2  
White

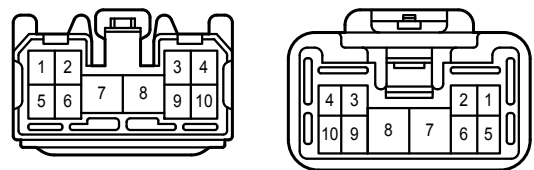

VL2

Black White

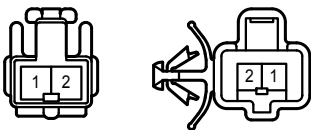

WM2

Black White

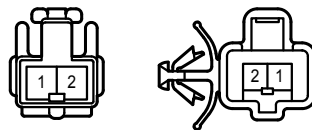



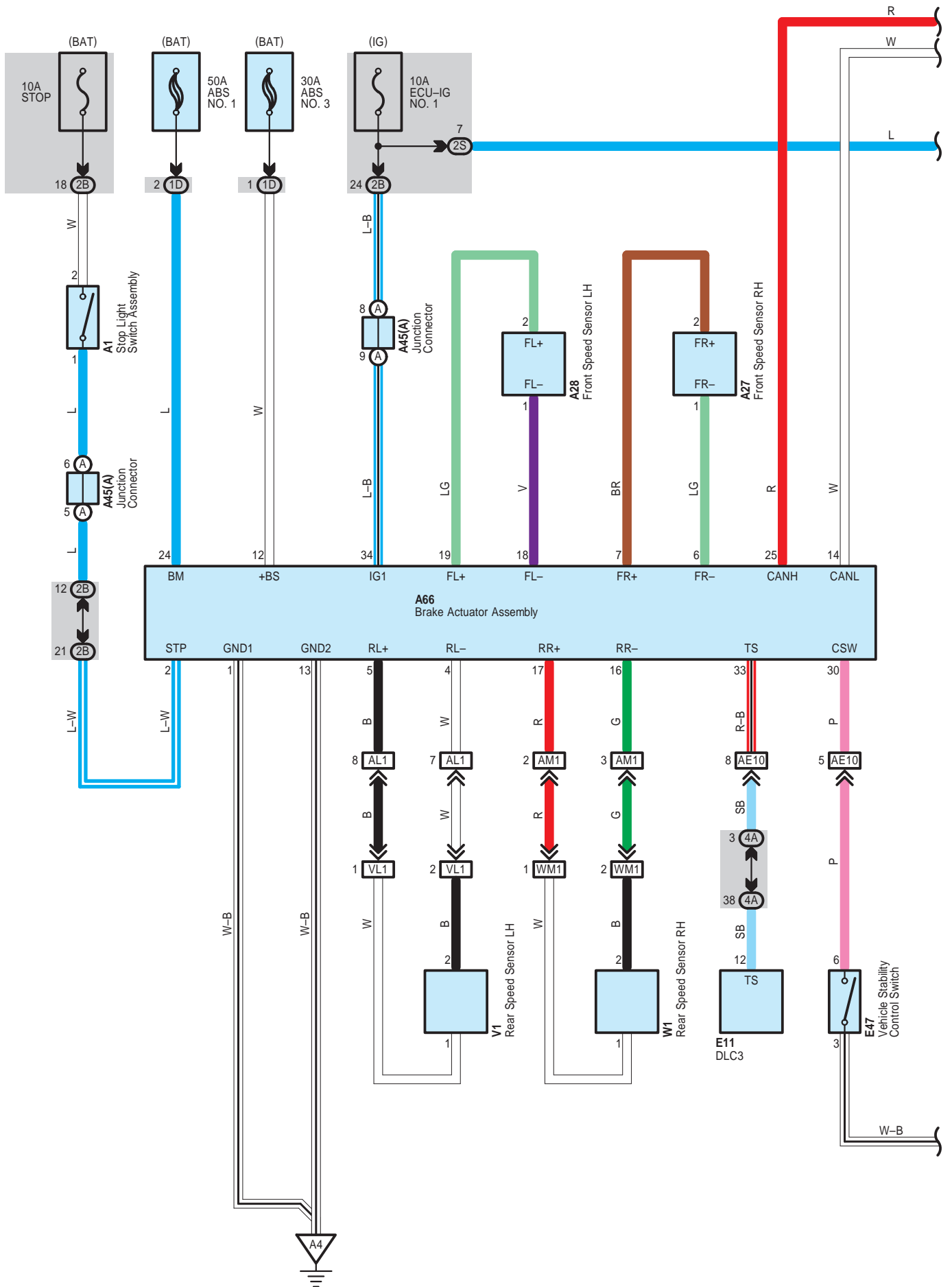

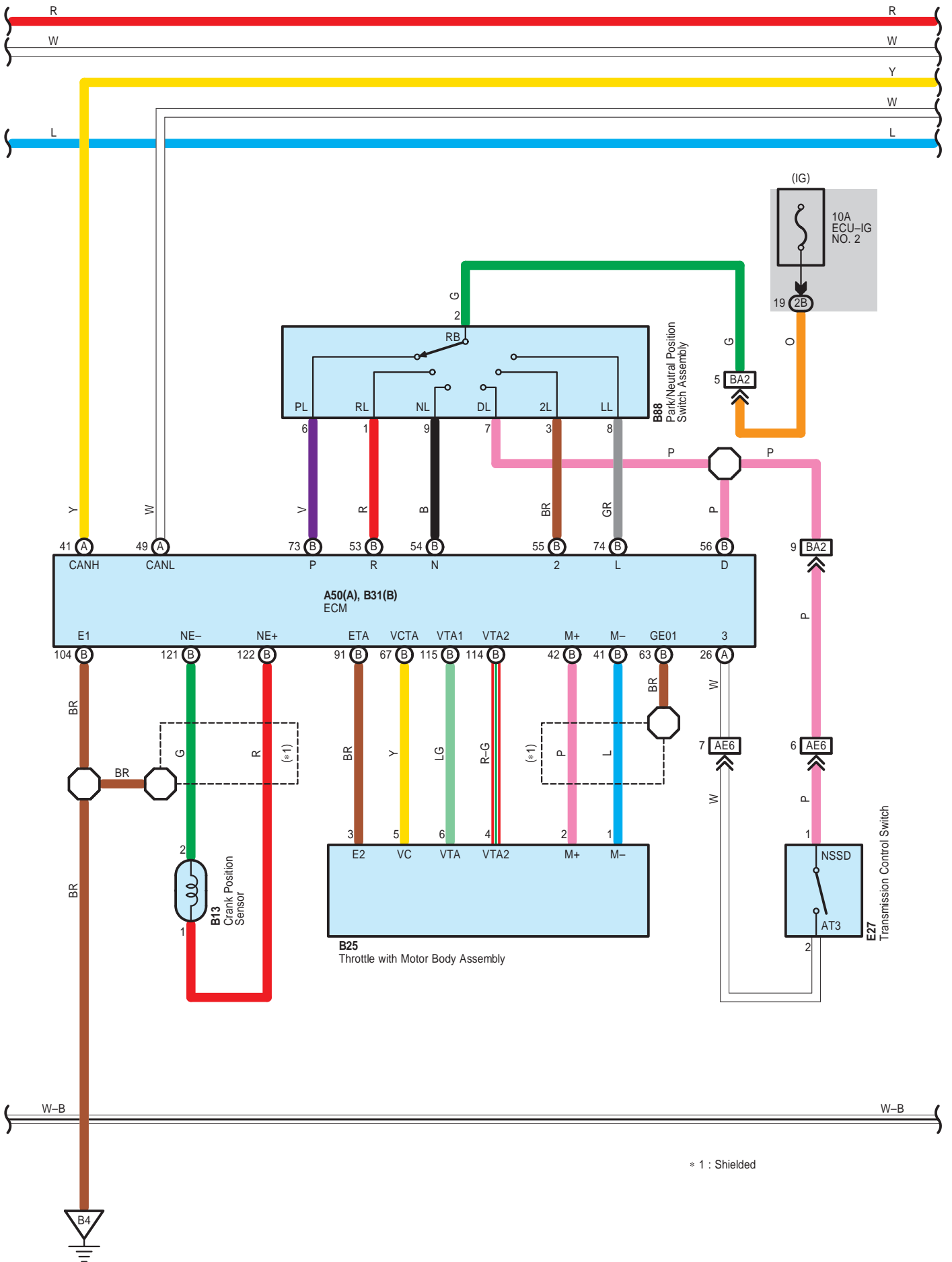

\* 1 : Shielded

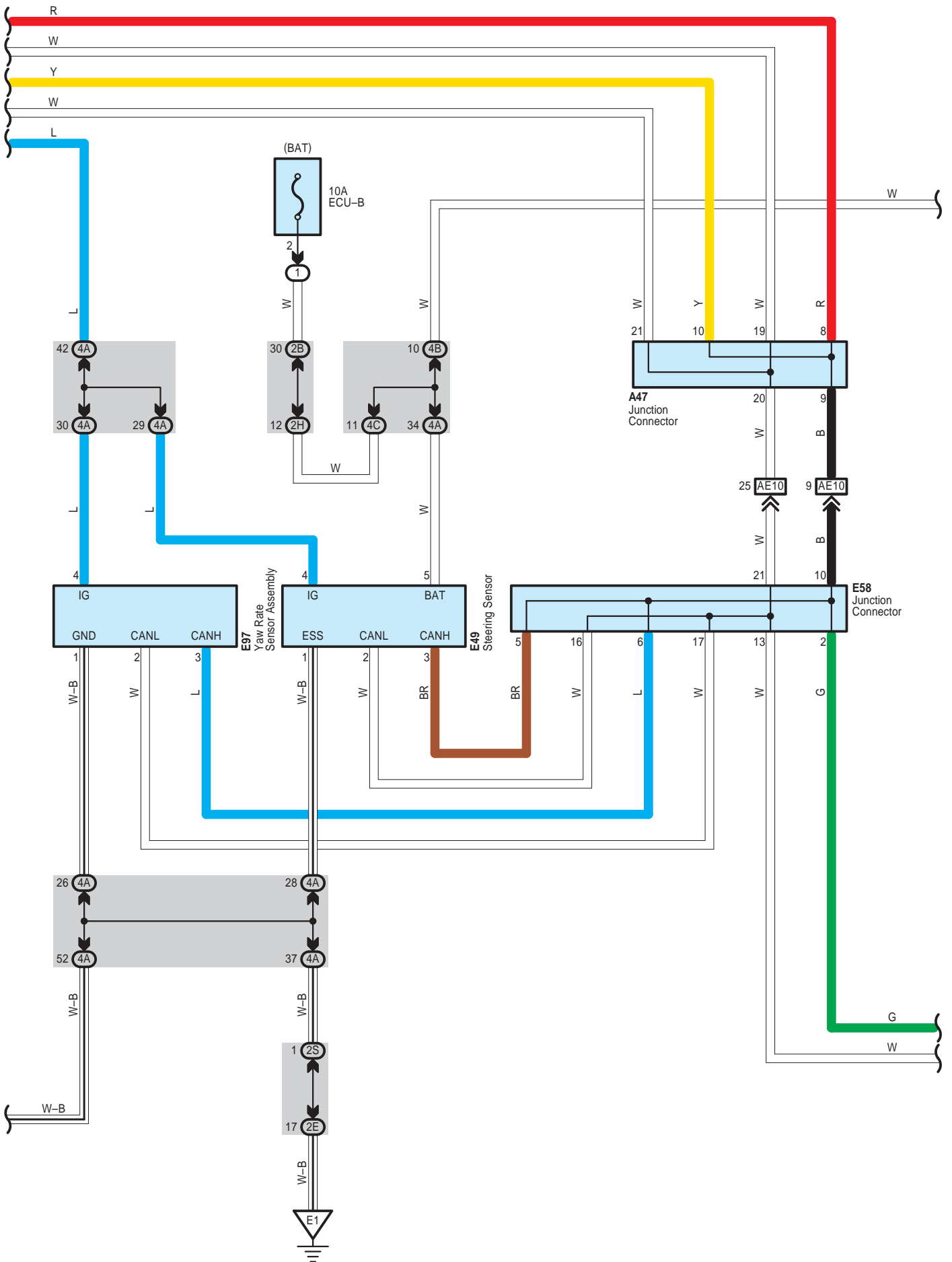

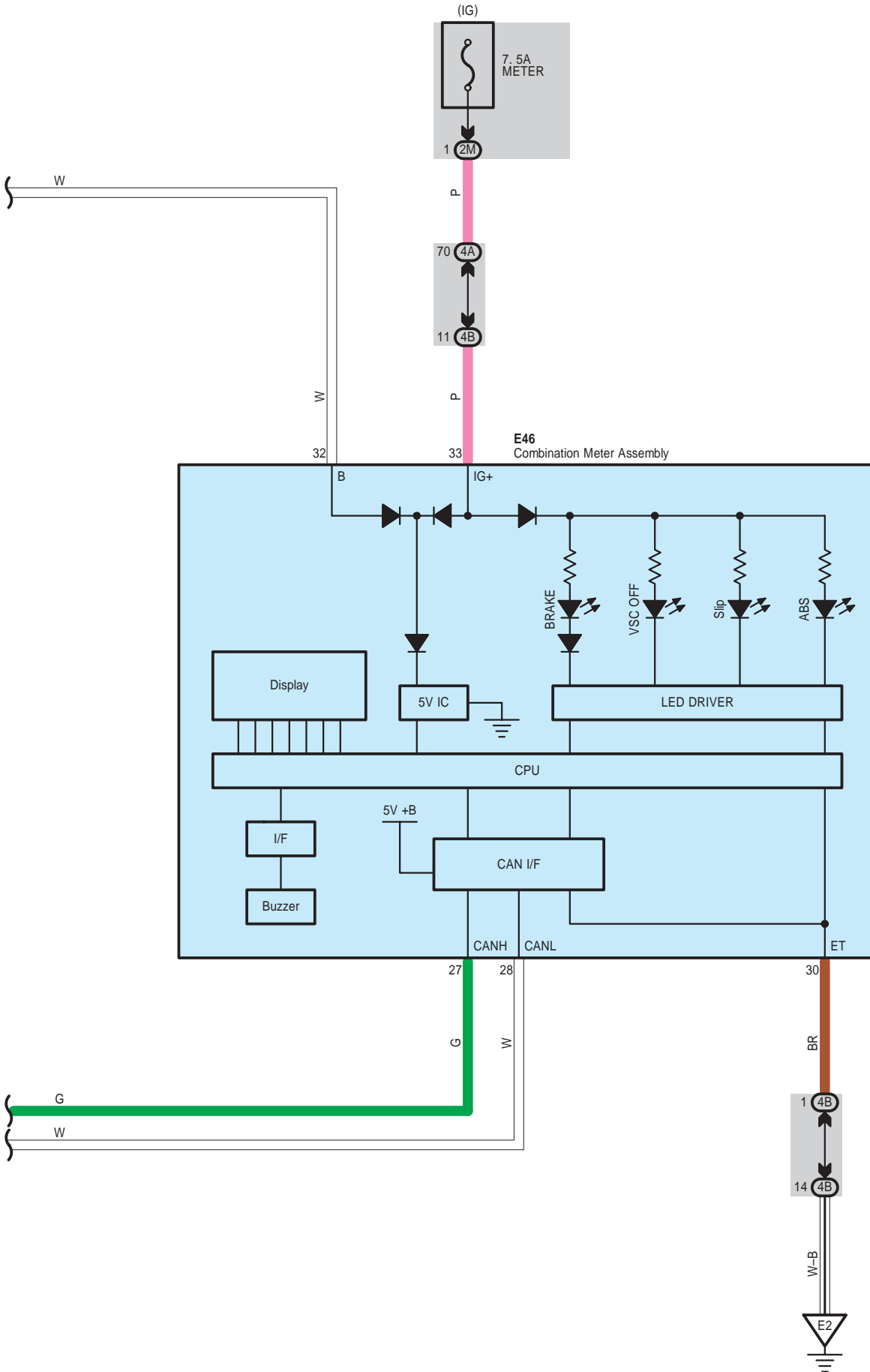

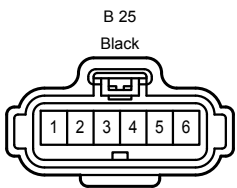
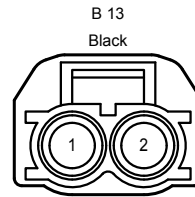
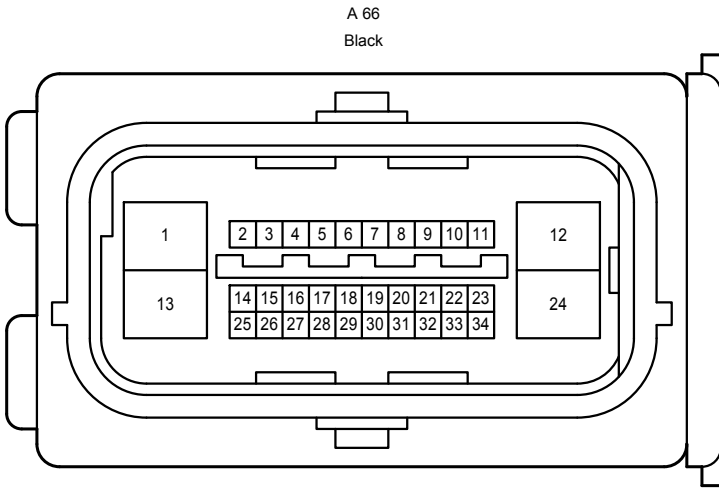
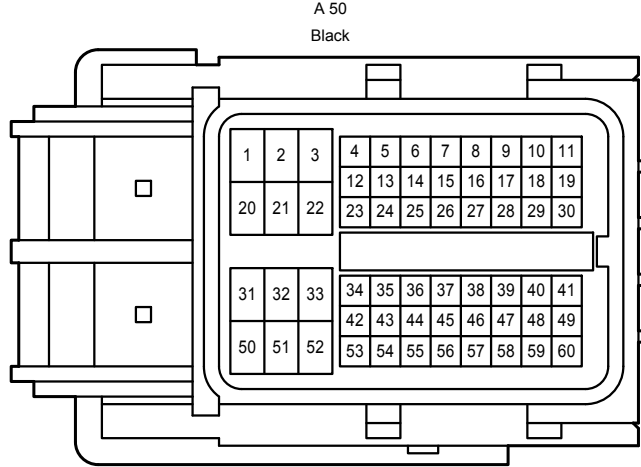
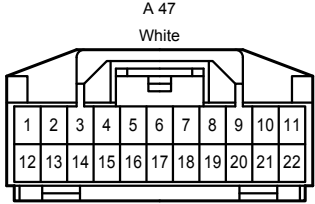
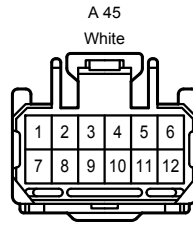
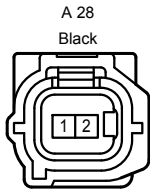
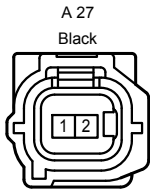
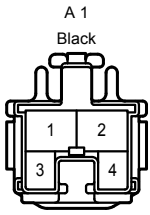

B 31  
Black

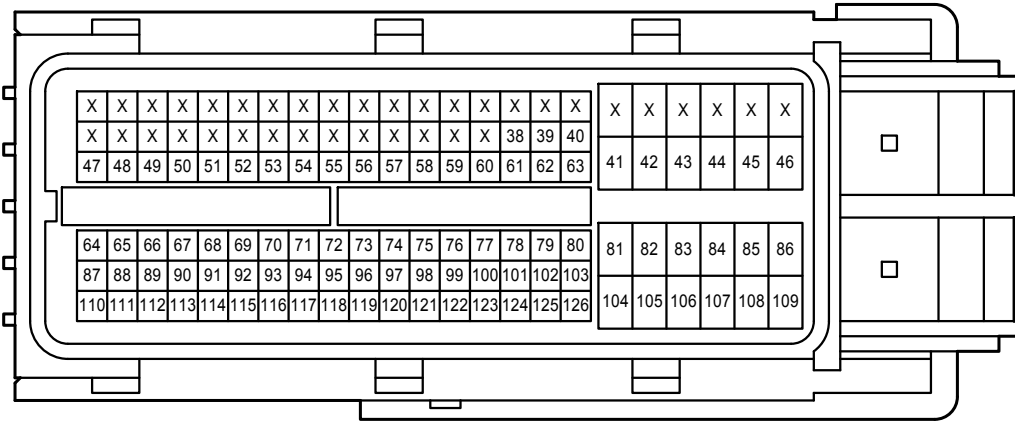

B 88  
Gray

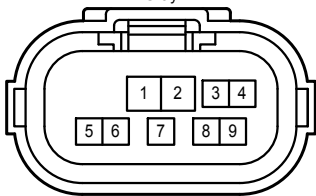

E 11  
White

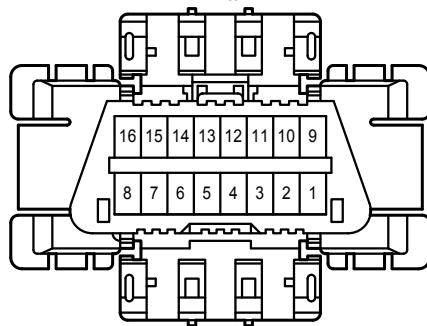

E 27  
White

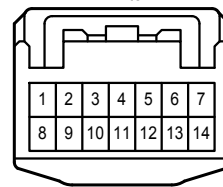

E 46  
White

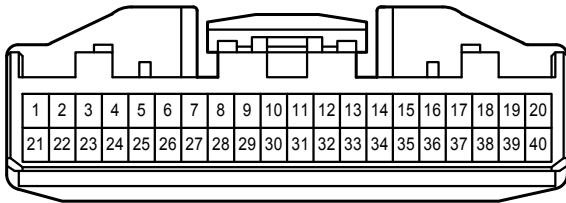

E 47  
White

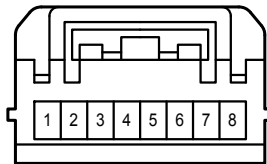

E 49  
Black

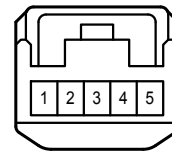

E 58  
Gray

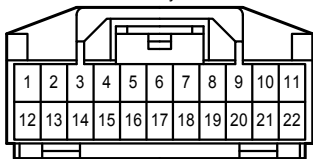

E 97  
Black

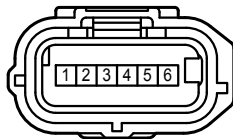

V 1  
Black

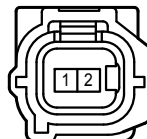

W 1  
Black



1D  
White

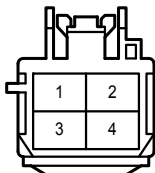

2B  
White

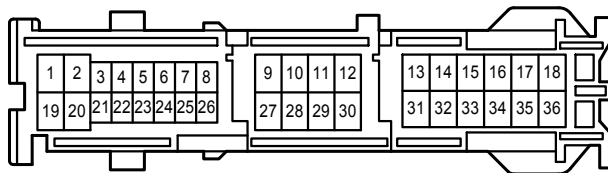

2E  
White

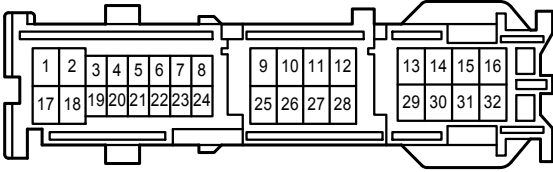

2H  
White

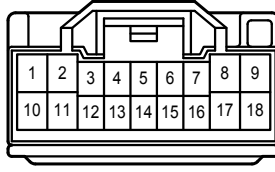

2M  
White

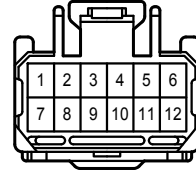

2S  
White

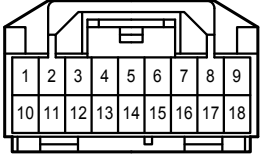

4A  
White

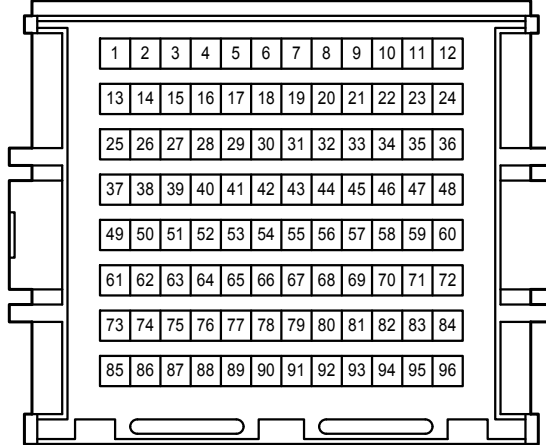

4B  
White

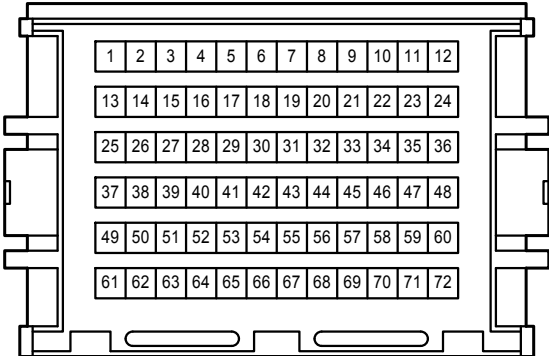

4C  
White

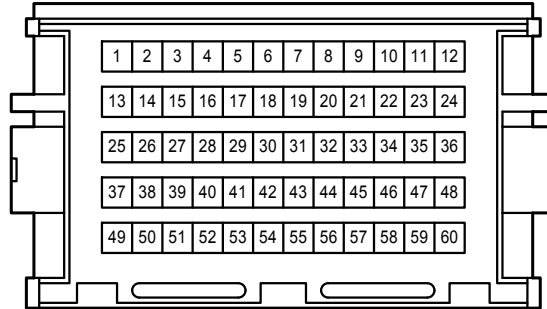

AE6  
Gray

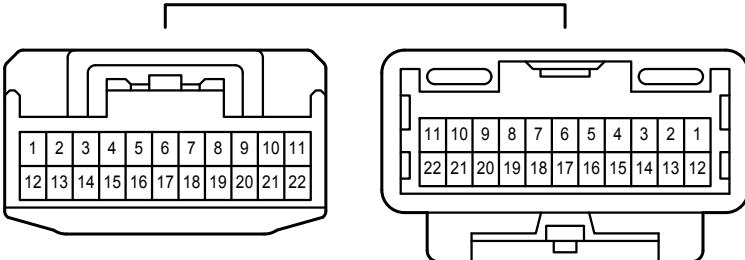

AE10  
Gray

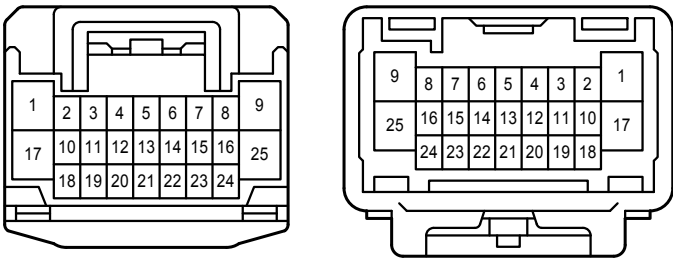

AL1  
White

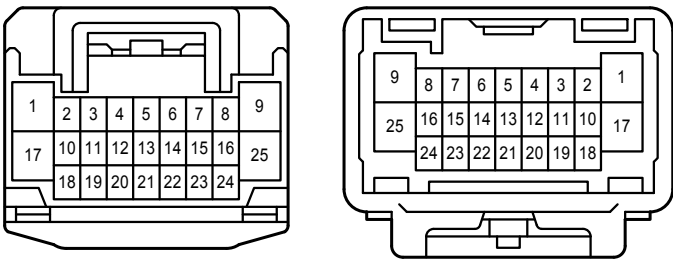

AM1  
White

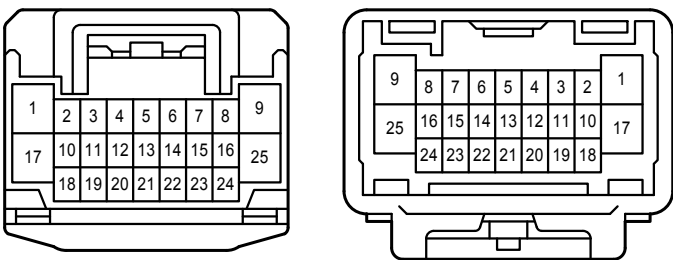

BA2  
White

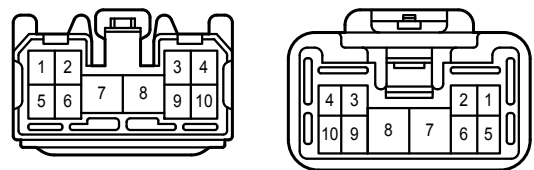

VL1  
Black

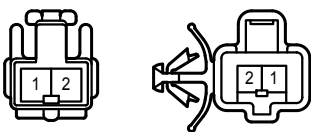

WM1  
Black

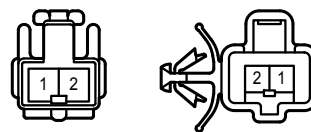



ABS <w/o VSC , Except TMC Made>

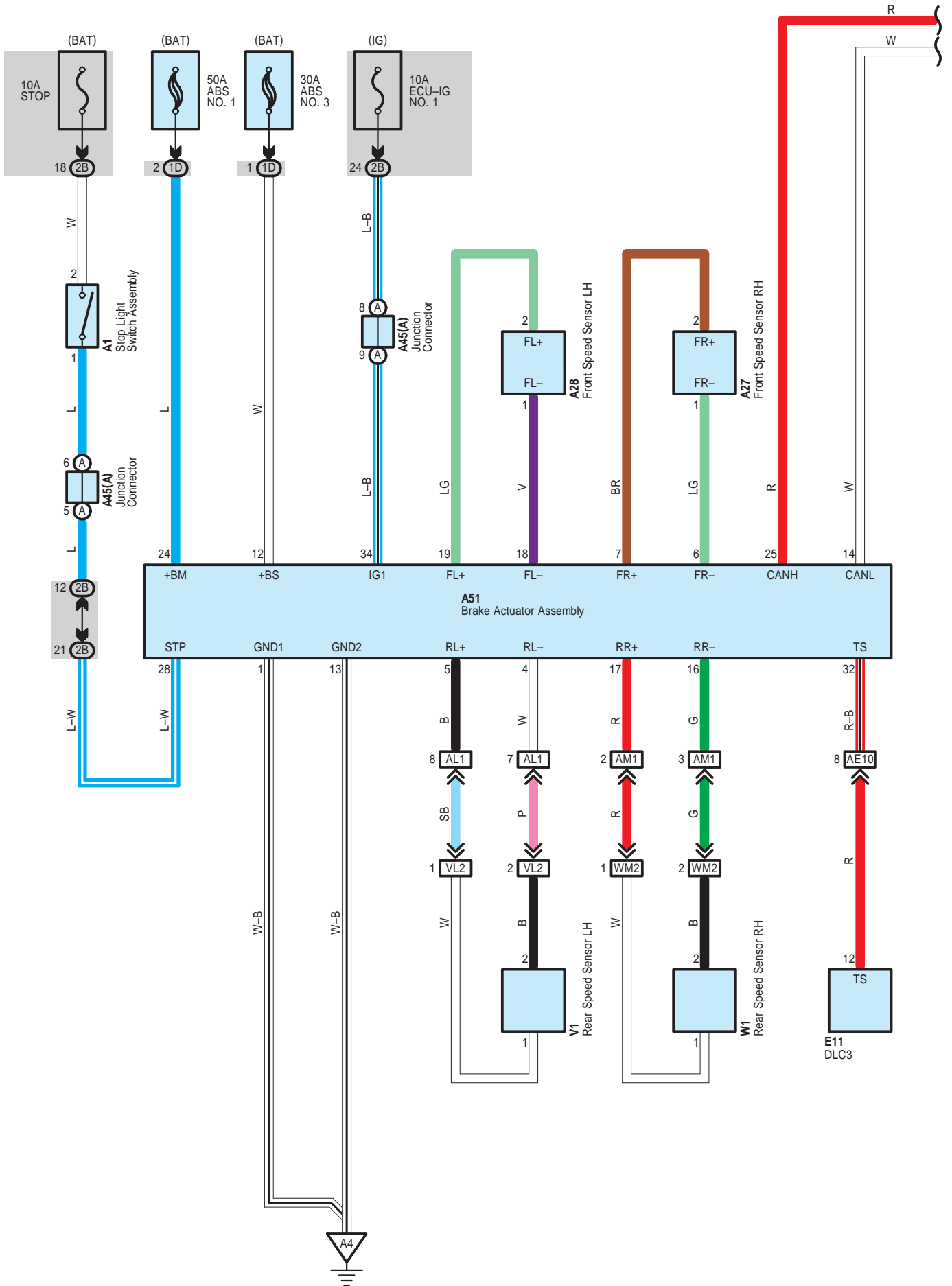

ABS <w/o VSC , Except TMC Made>

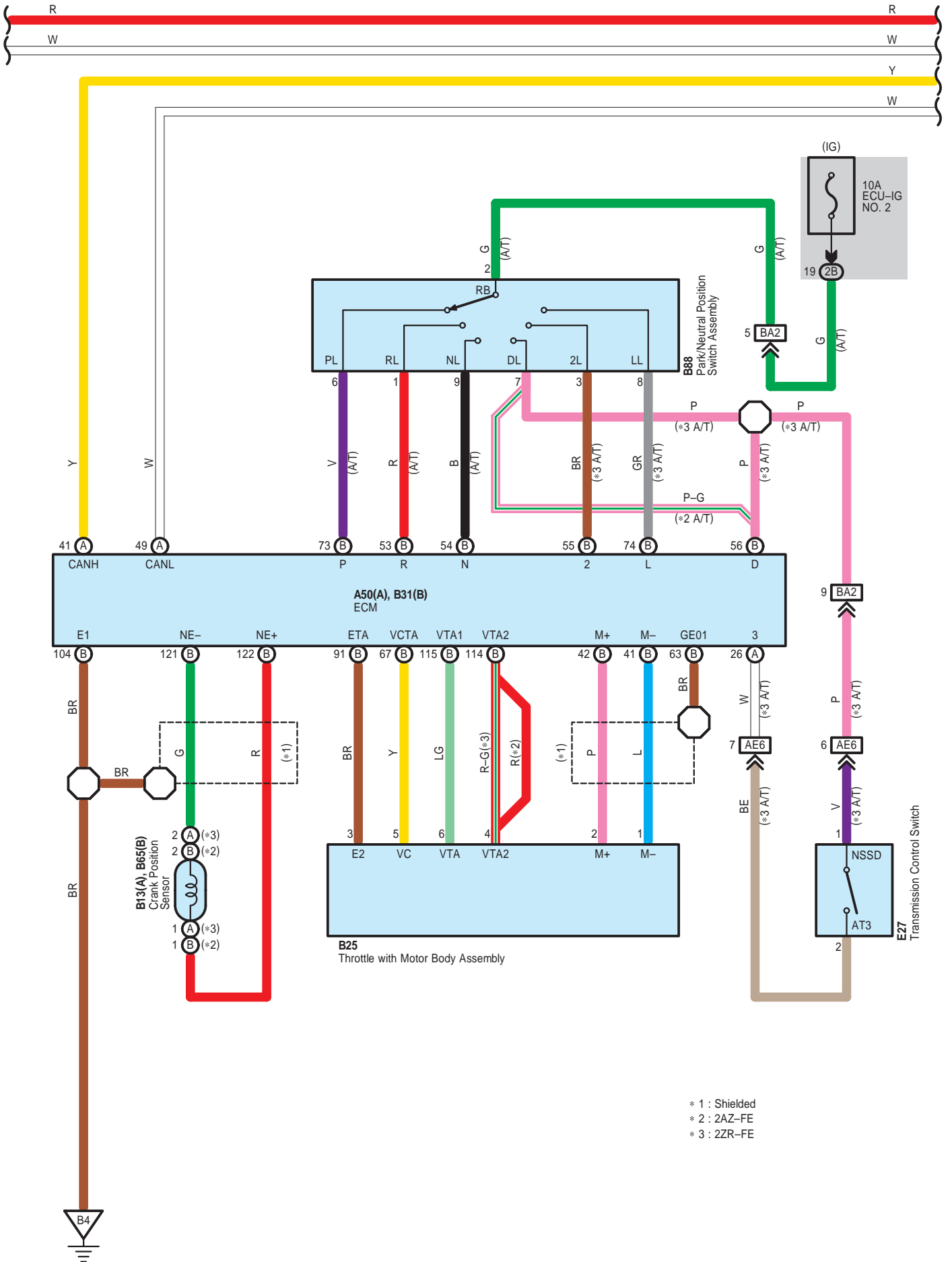

- \* 1 : Shielded
- \* 2 : 2AZ-FE
- \* 3 : 2ZR-FE

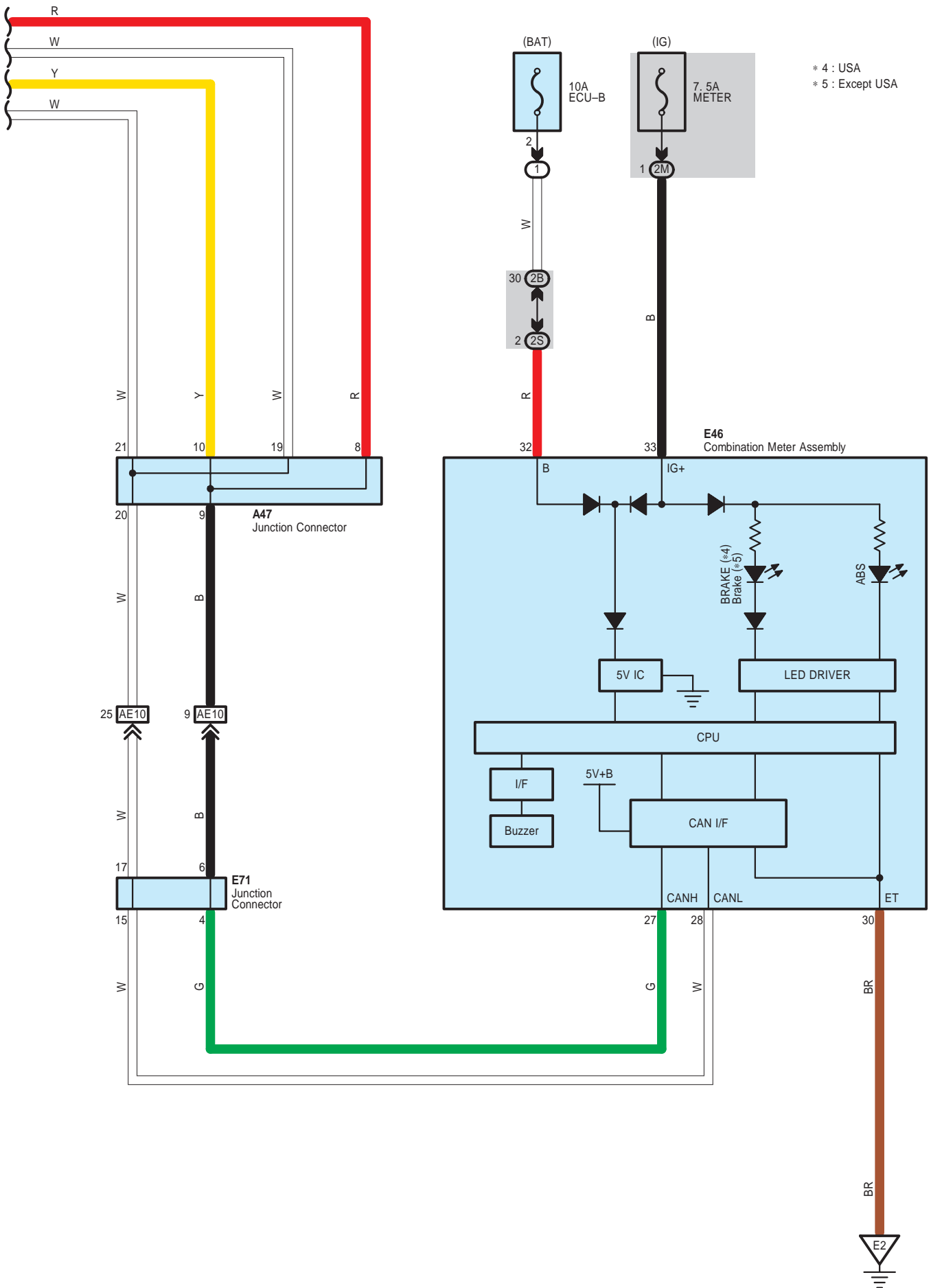

ABS <w/o VSC , Except TMC Made>

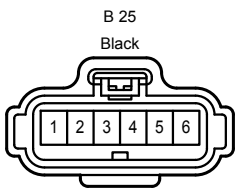
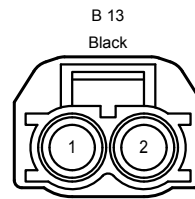
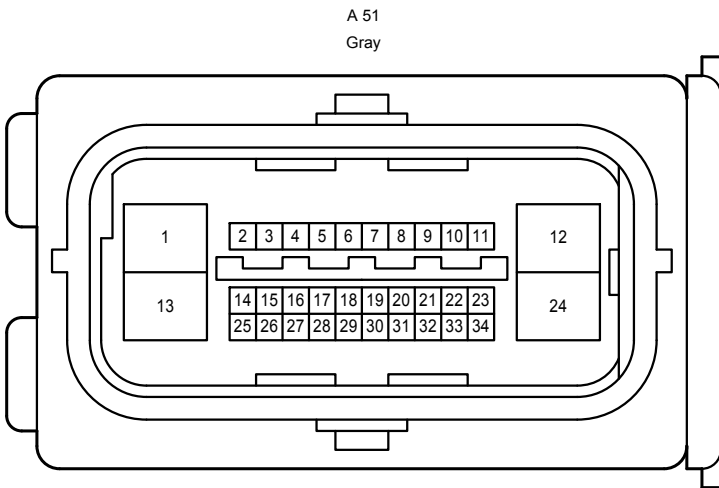
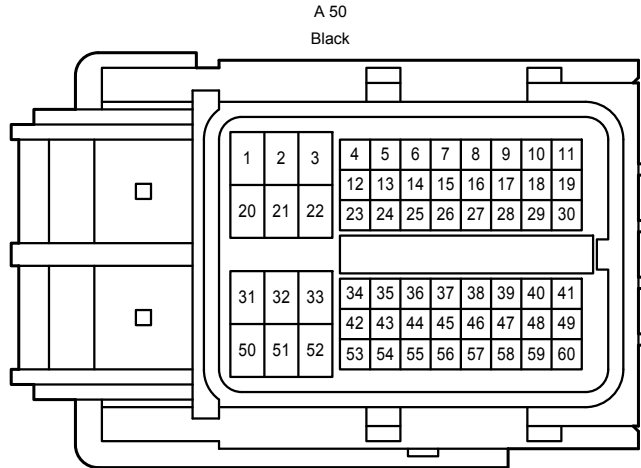
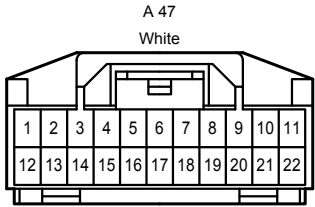
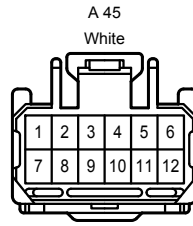
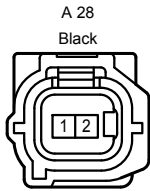
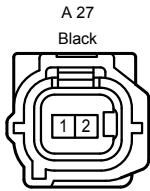
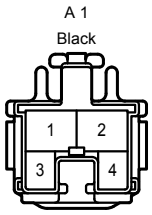

B 31  
Black

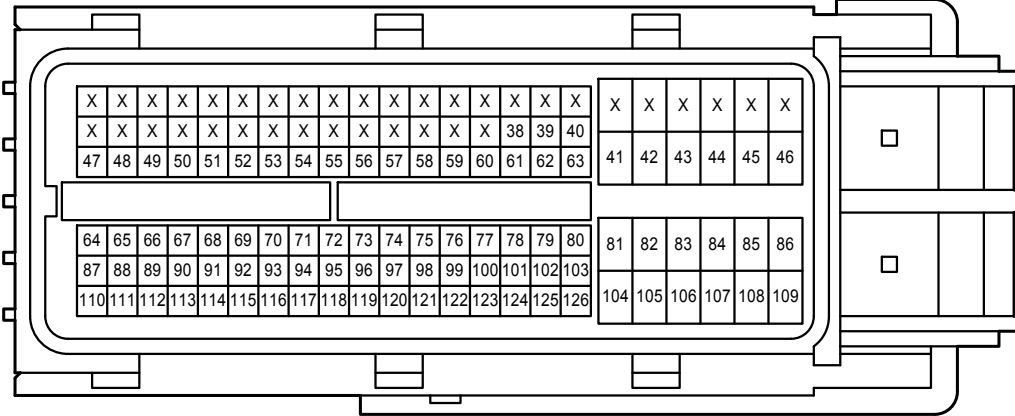

B 65  
Gray



B 88  
Gray

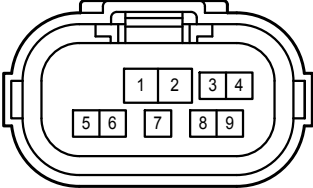

E 11  
White

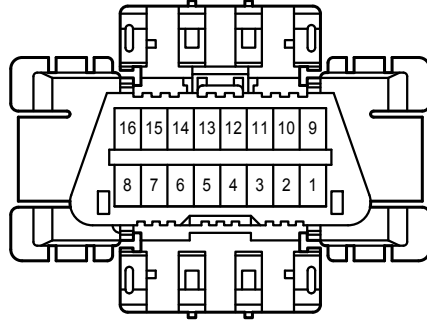

E 27  
White

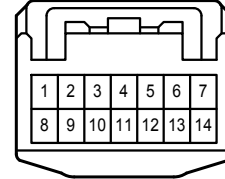

E 46  
White

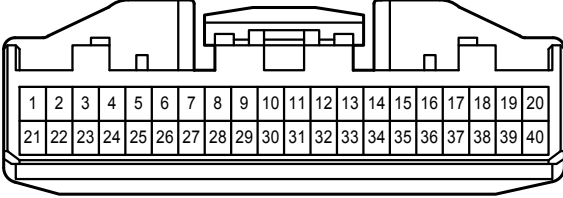

E 71  
White

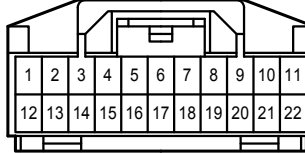

V 1  
Black

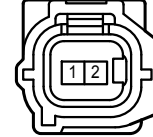

W 1  
Black



1D  
White

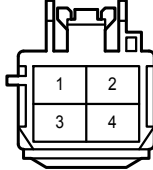

2B  
White

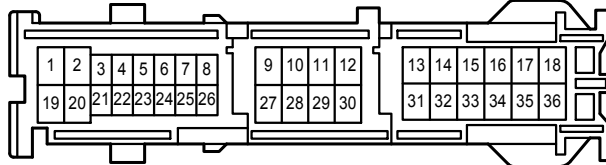

2M  
White

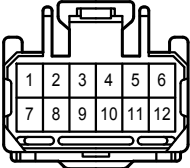

2S  
White

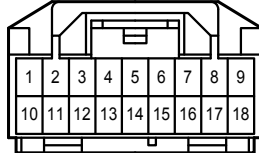

AE6  
Gray

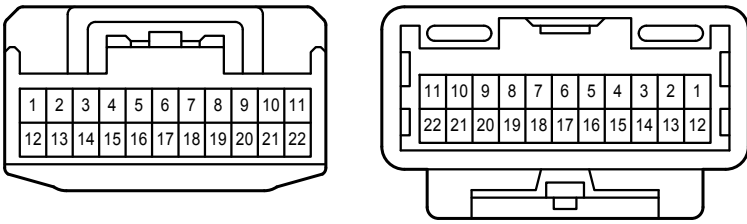

AE10  
Gray

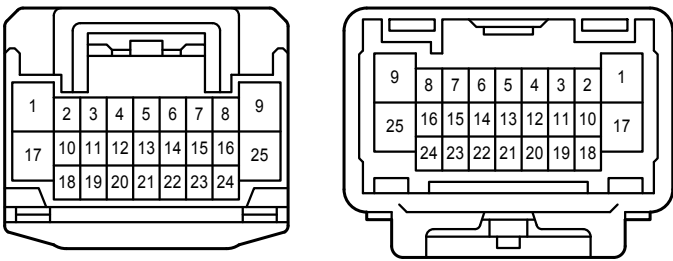

AL1  
White

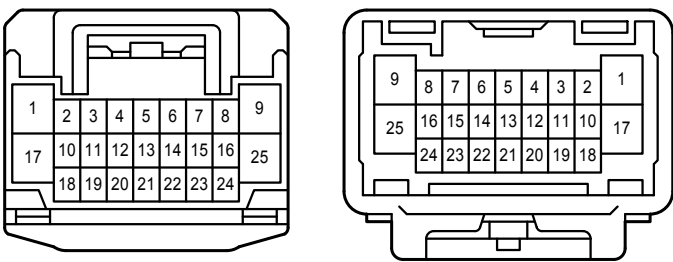

AM1  
White

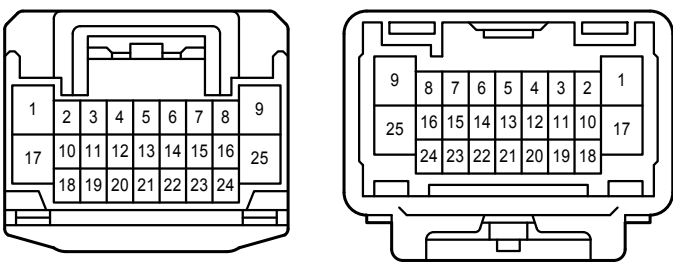

BA2  
White

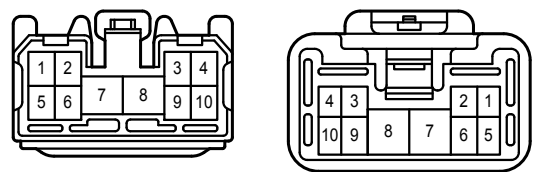

VL2

Black White

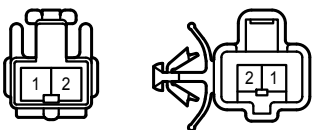

WM2

Black White

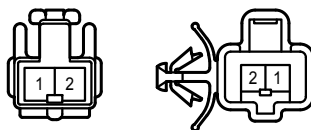

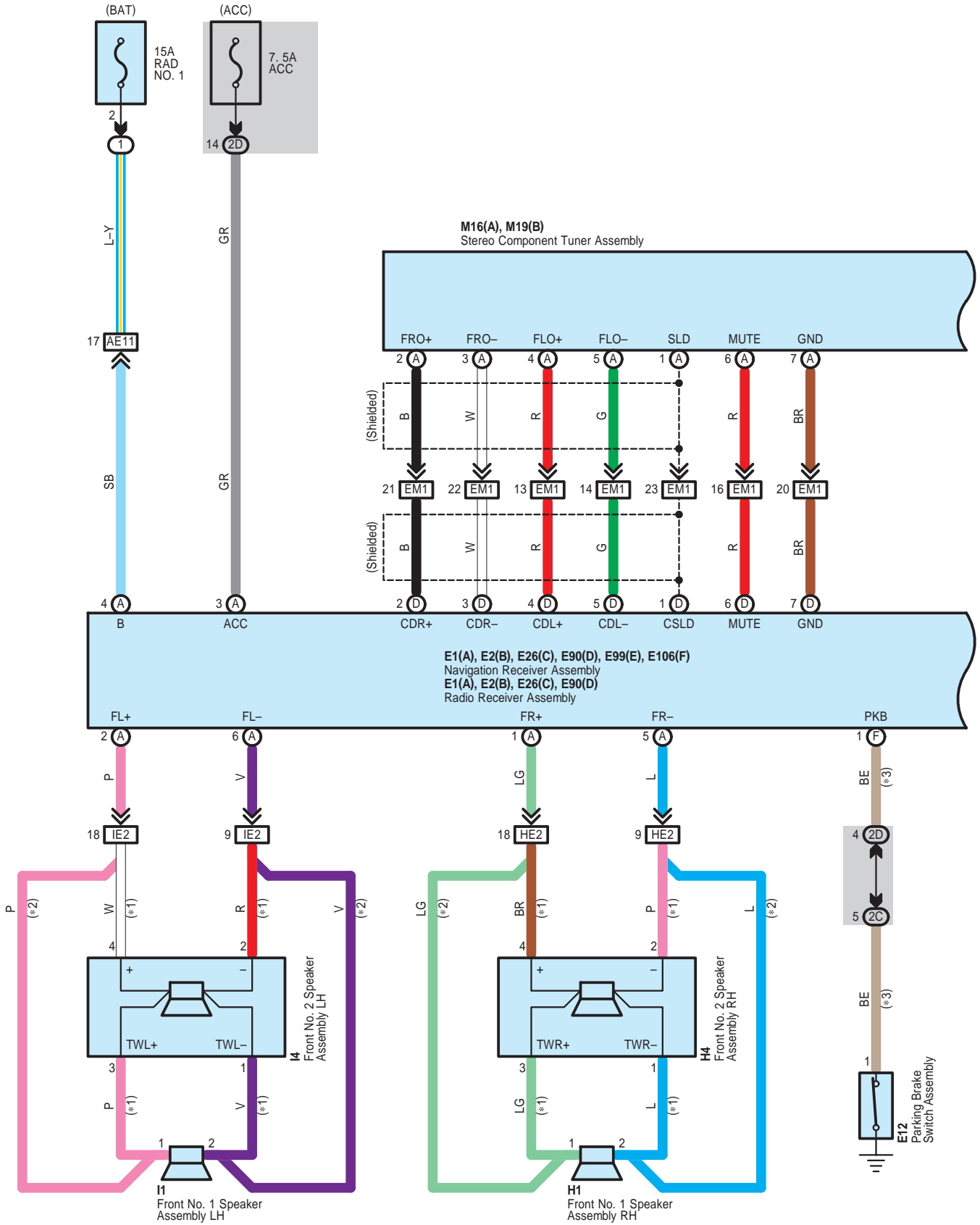

- \* 1 : 6 Speaker
- \* 2 : 4 Speaker
- \* 3 : w/ Navigation System
- \* 5 : w/ Steering Pad Switch

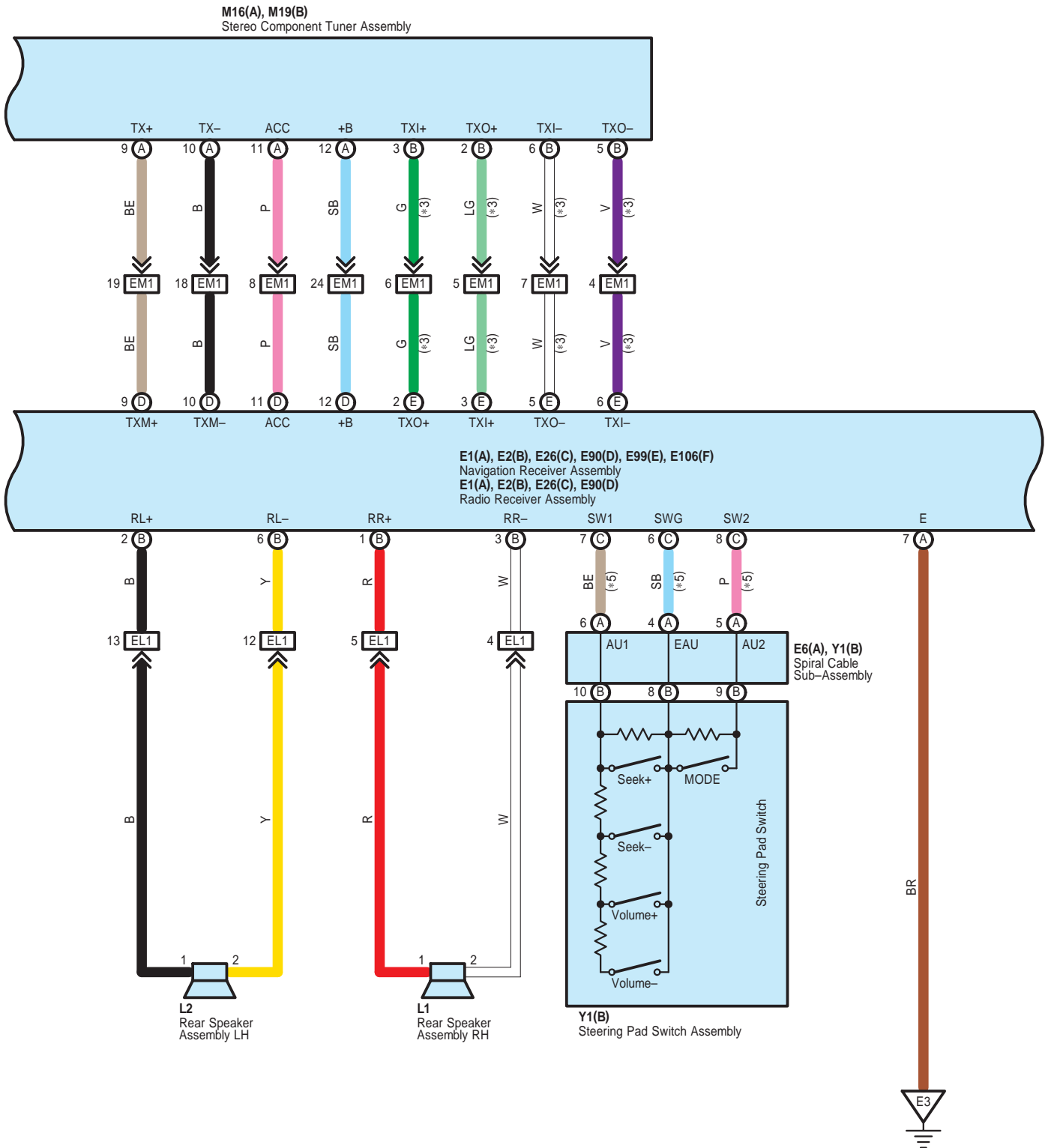



- \* 3 : w/ Navigation System
- \* 4 : w/o Navigation System
- \* 6 : 2AZ-FE
- \* 7 : 2ZR-FE

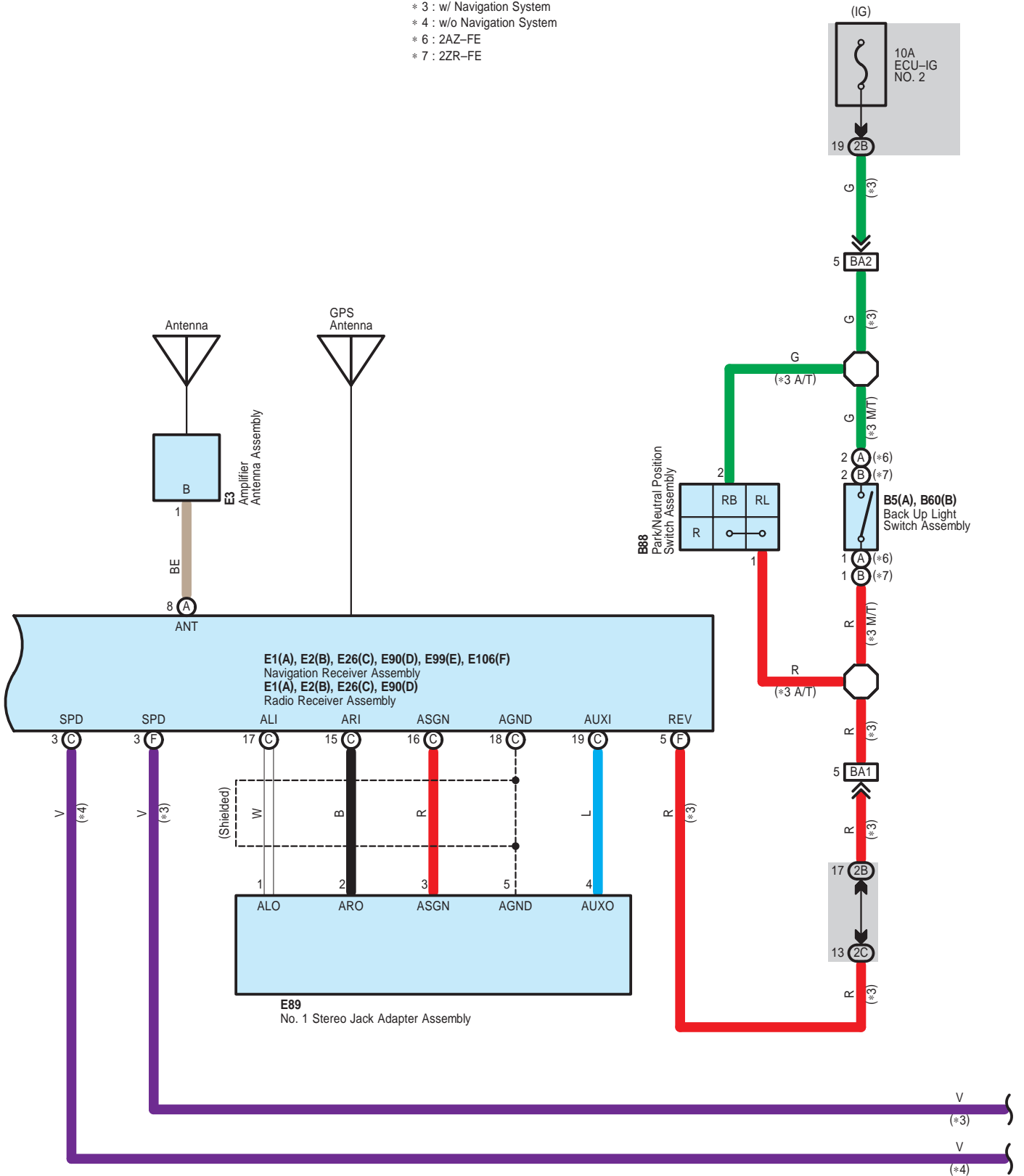

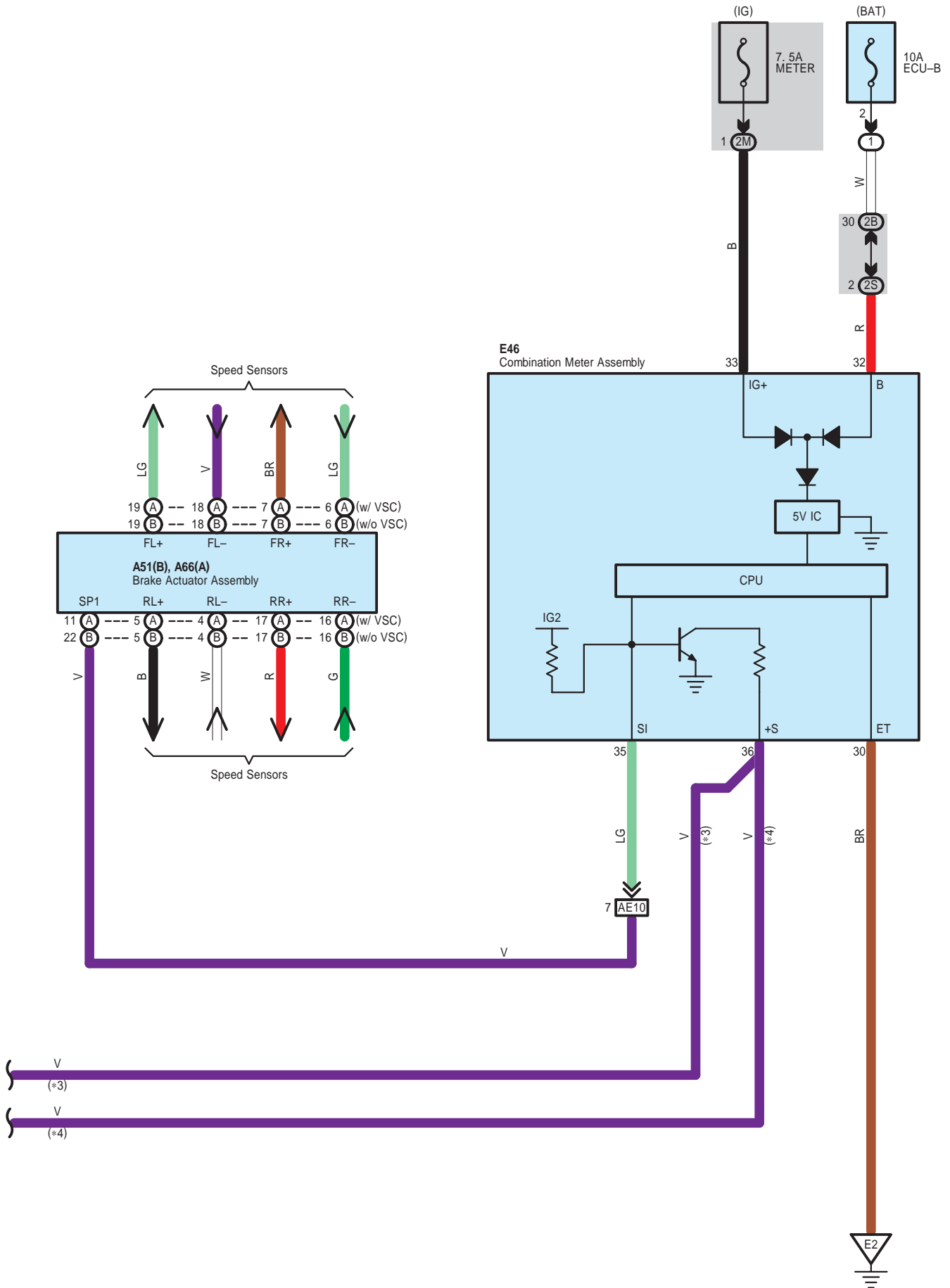

A 51  
Gray

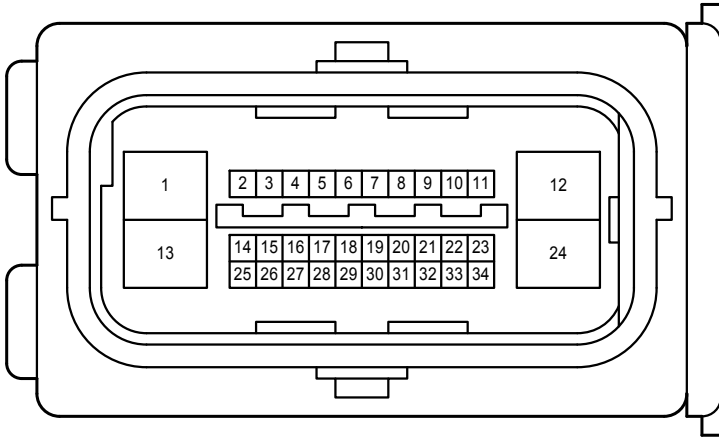

A 66  
Black

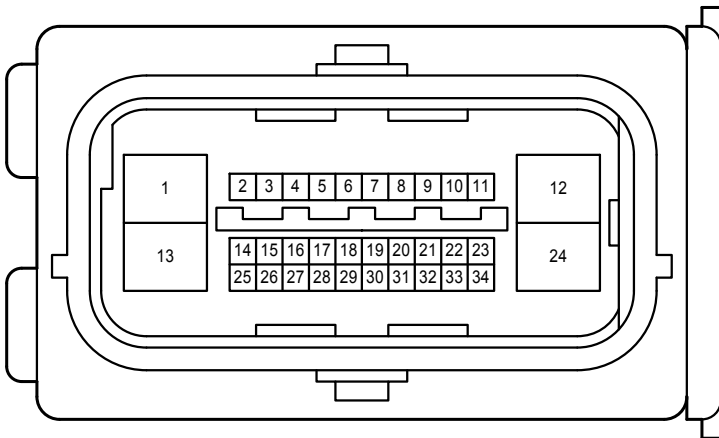

B 5  
Gray

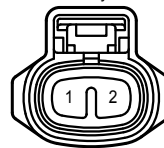

B 60  
Gray

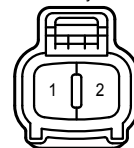

B 88  
Gray

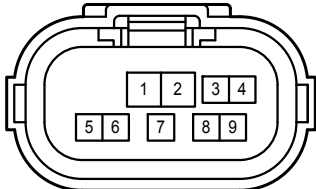

E 1  
White

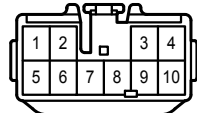

E 2  
White

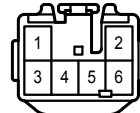

E 3  
White



E 6  
Black

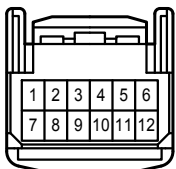

E 12  
White



E 26  
White

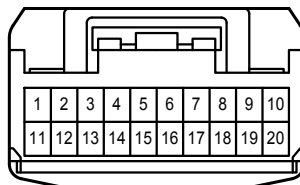

E 46  
White

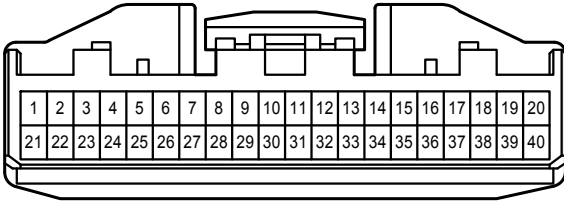

E 89  
White

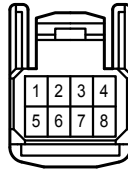

E 90  
White

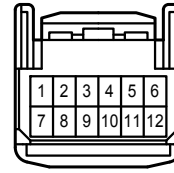

E 99  
Blue

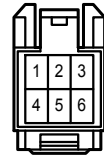

E106  
Gray

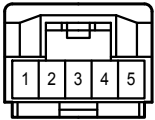

H 1  
White



H 4  
White

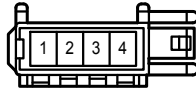

I 1  
White



I 4  
White

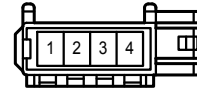

L 1  
White

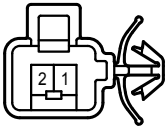

L 2  
White

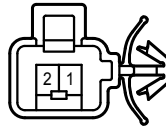

M 16  
White

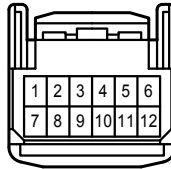

M 19  
Blue

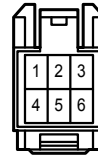

Y 1  
White

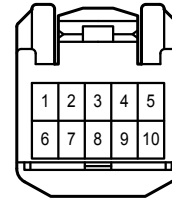

2B  
White

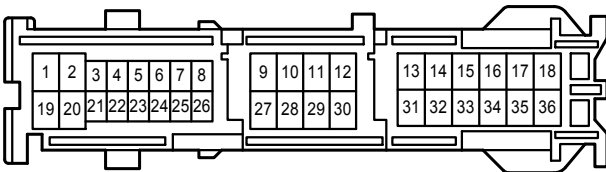

2C  
White

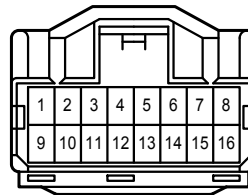

2D  
White

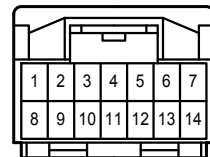

2M  
White

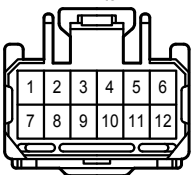

2S  
White

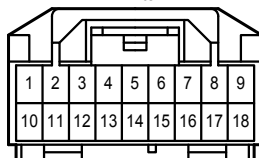

AE10  
Gray

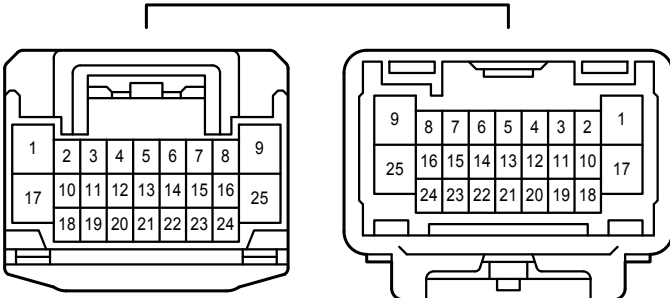

AE11  
White

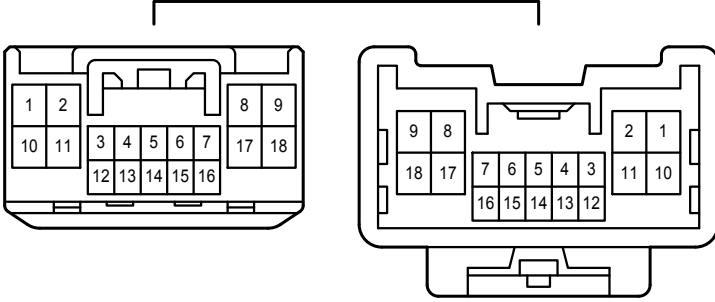

BA1  
White

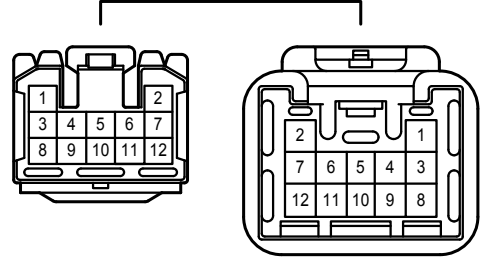

BA2  
White

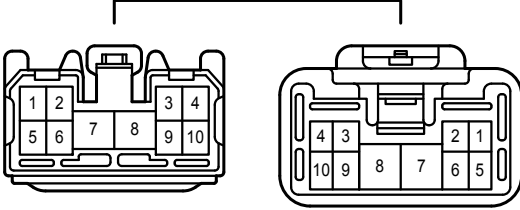

EL1  
White

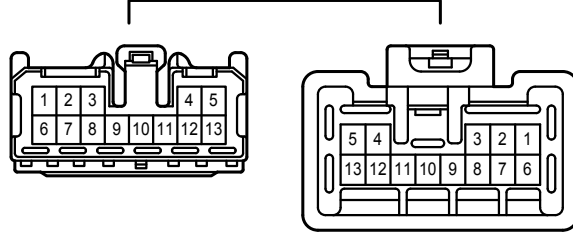

EM1  
Gray

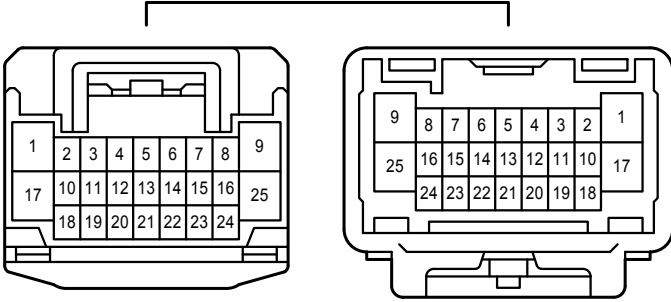

HE2  
White

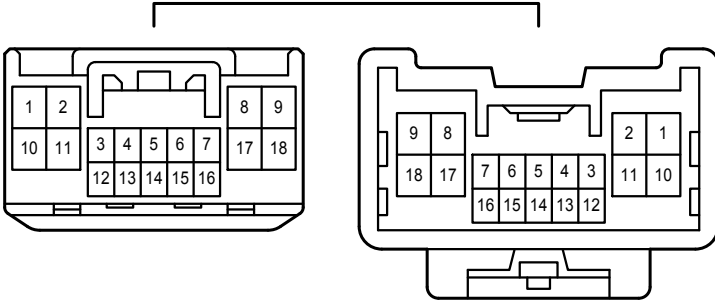

IE2  
White

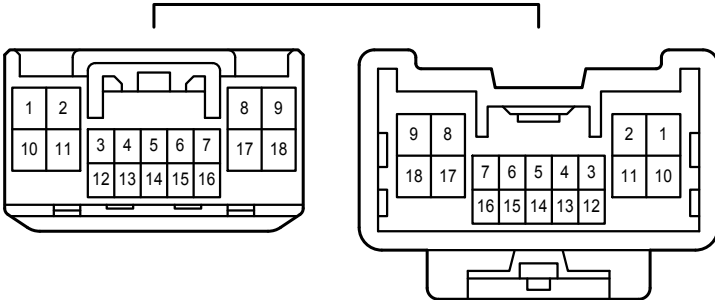

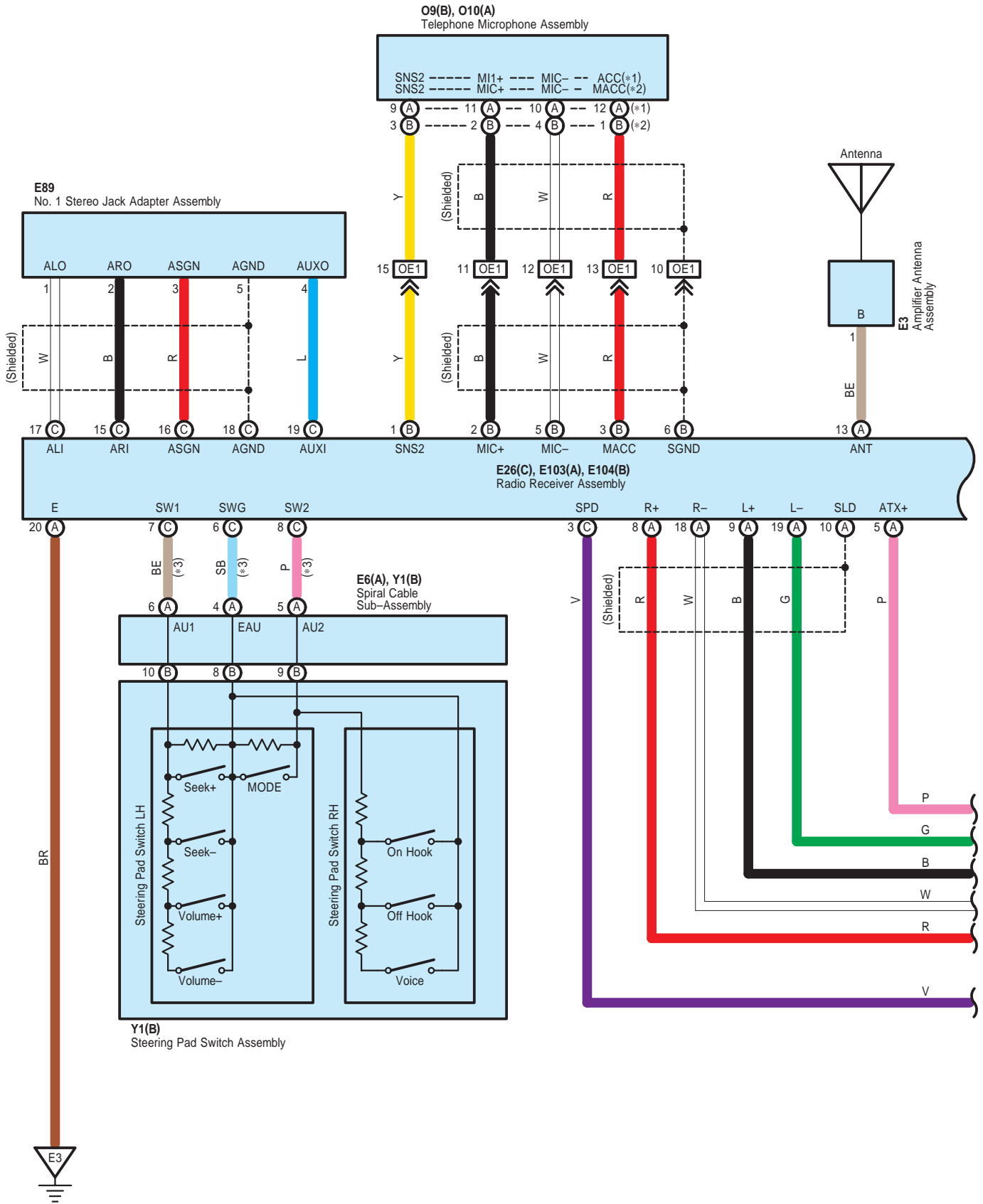

Audio System <Separate Type Amplifier , Except TMC Made>

- \* 1 : w/ Sliding Roof
- \* 2 : w/o Sliding Roof
- \* 3 : w/ Steering Pad Switch

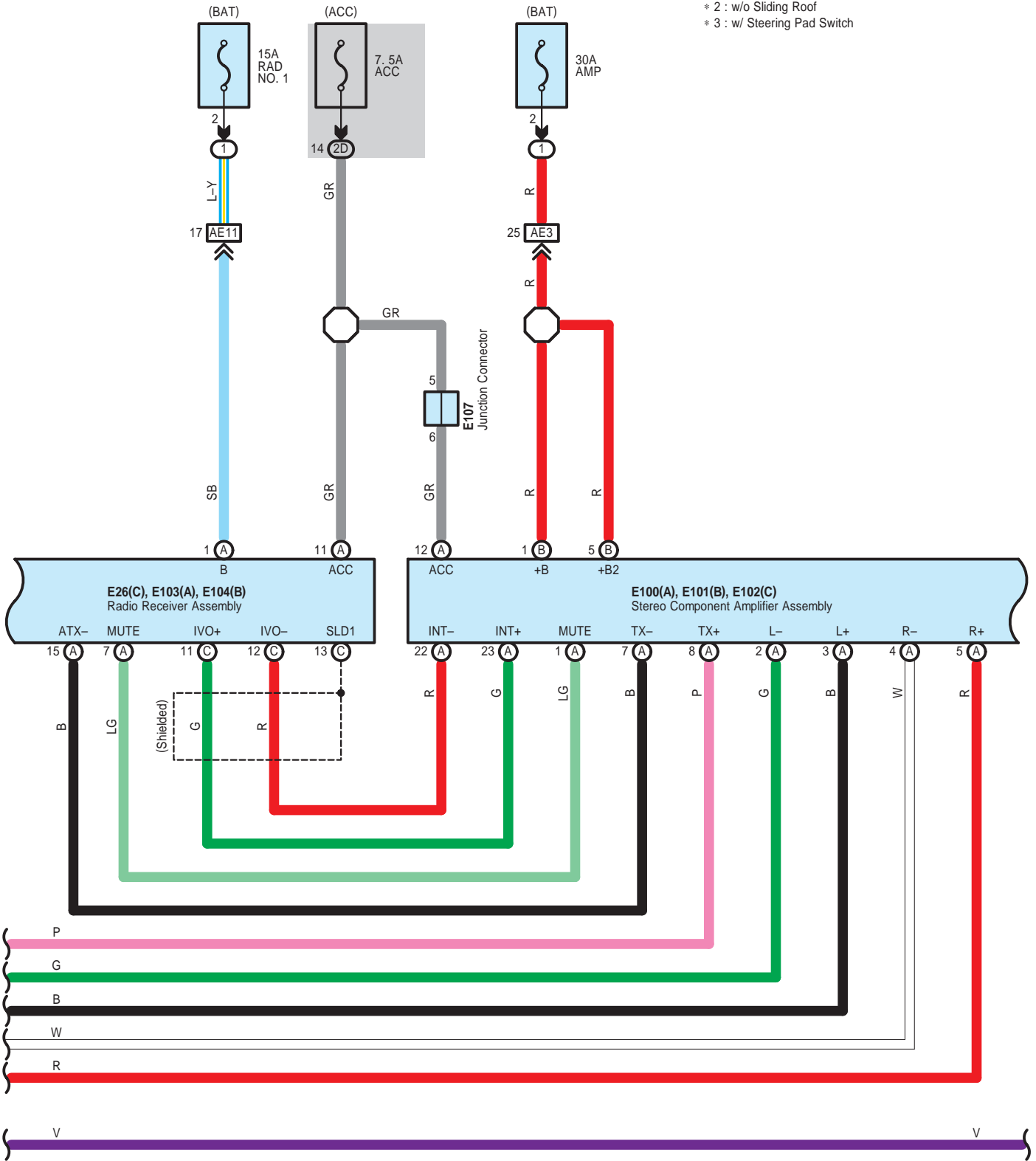

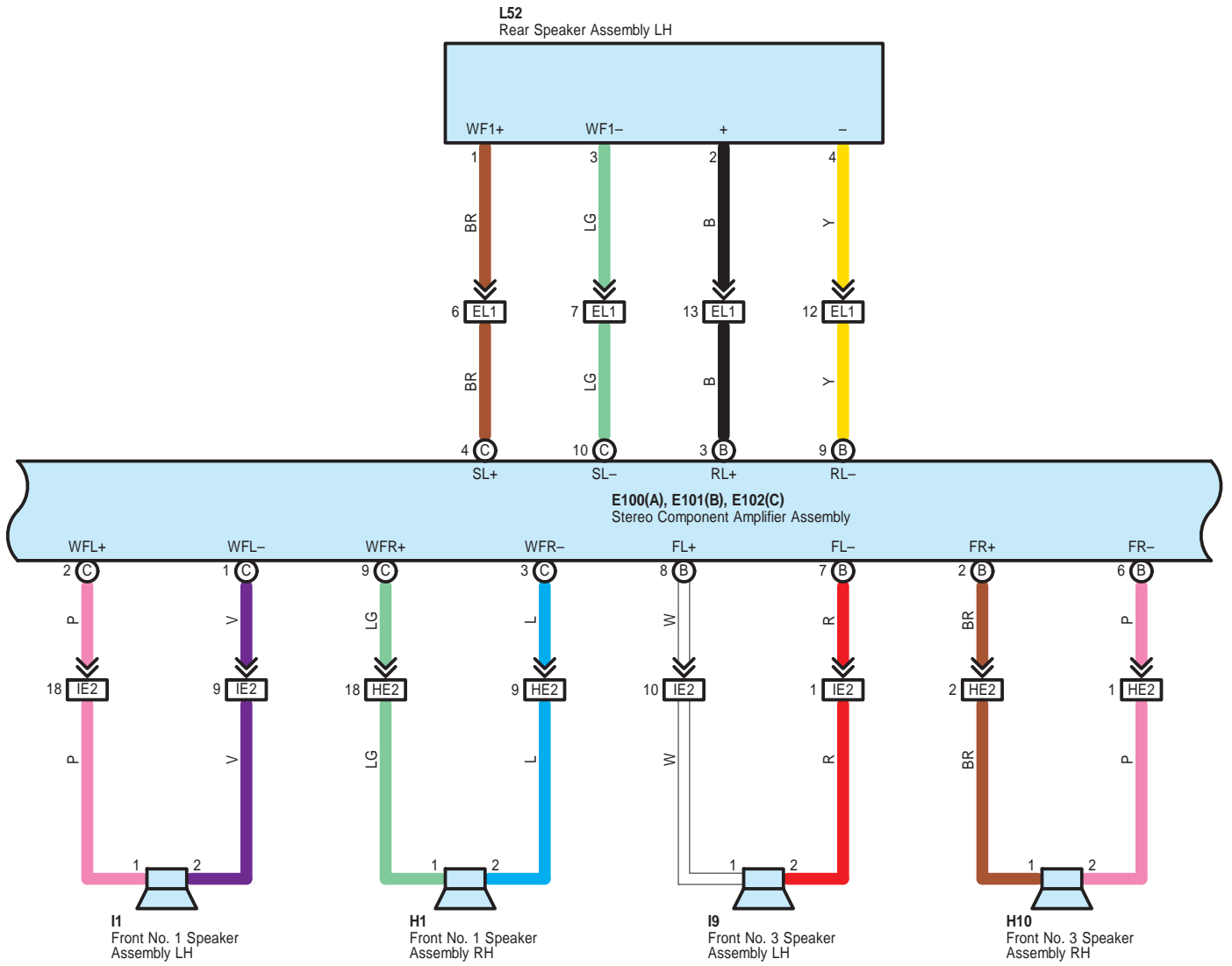



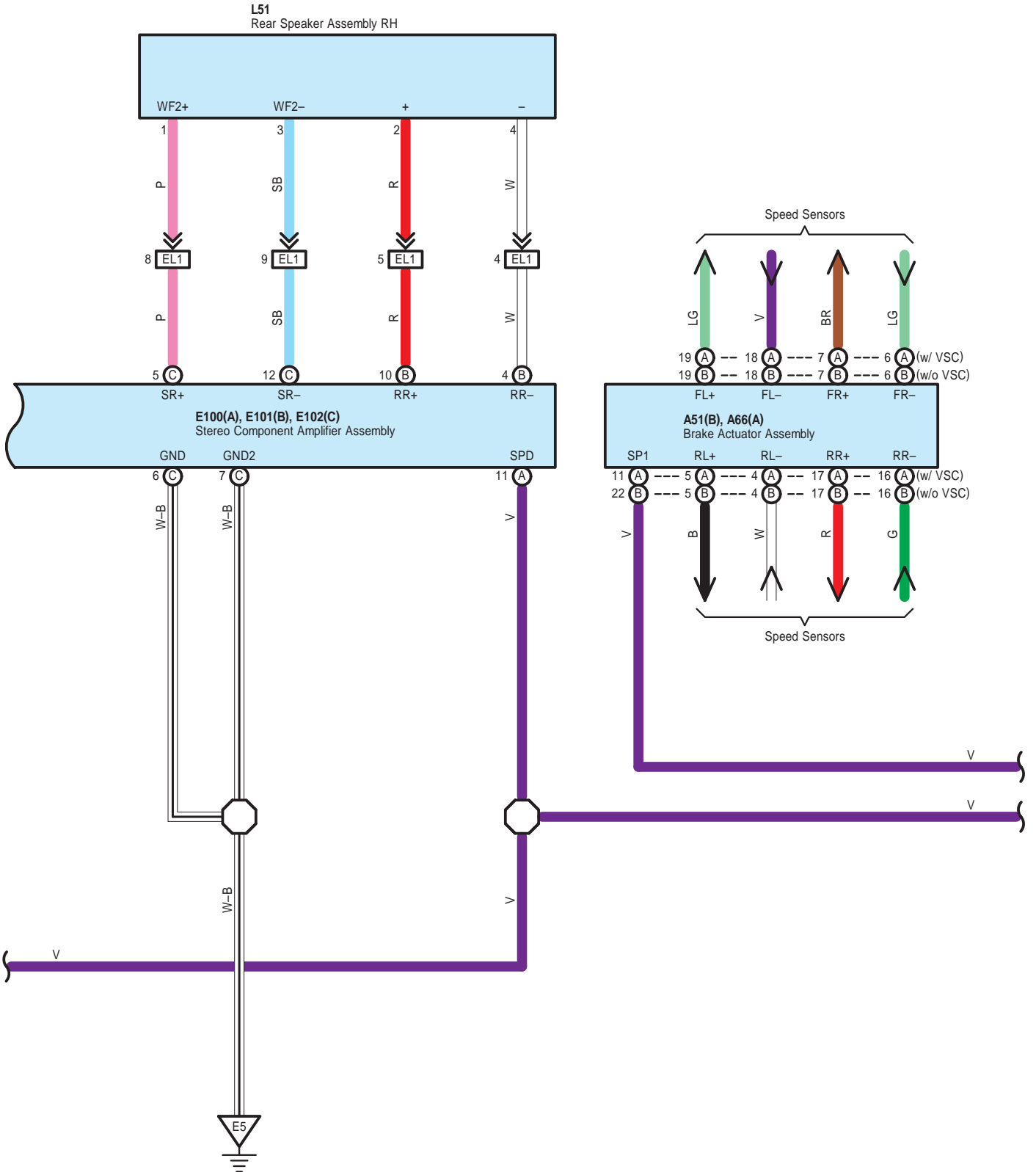

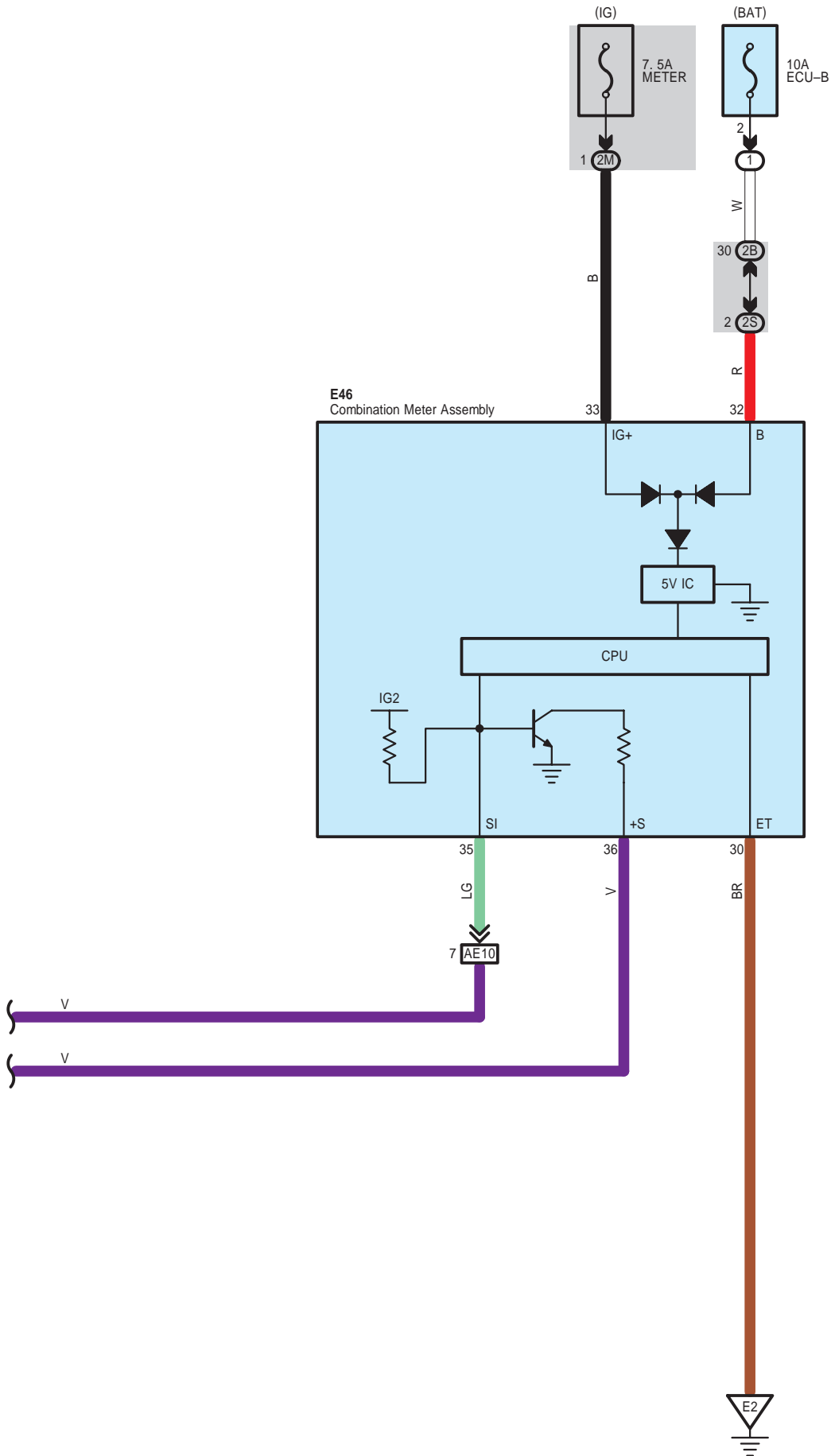

Audio System <Separate Type Amplifier , Except TMC Made>

A 51  
Gray

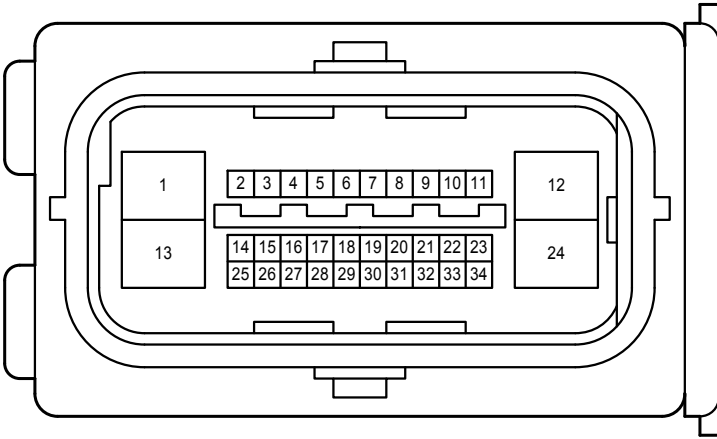

A 66  
Black

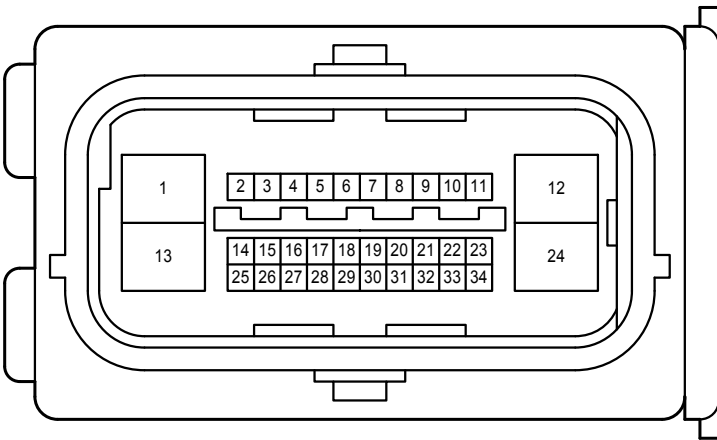

E 3  
White



E 6  
Black

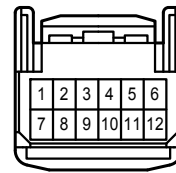

E 26  
White

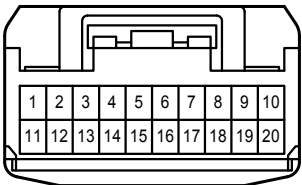

E 46  
White

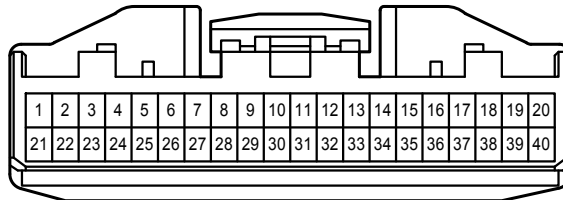

E 89  
White

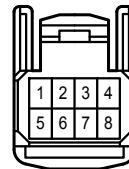

E100  
White

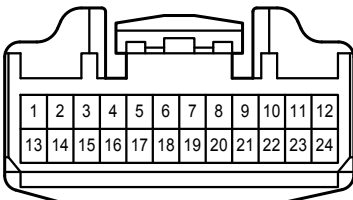

E101  
Blue

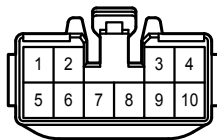

E102  
White

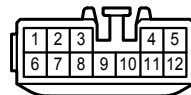

Audio System <Separate Type Amplifier , Except TMC Made>

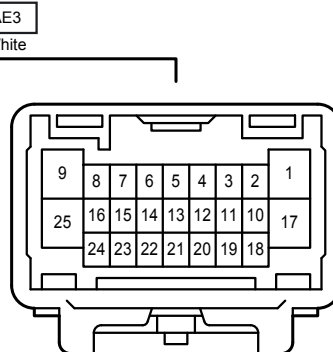
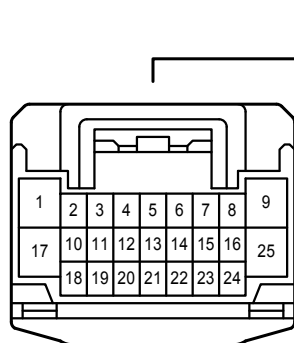
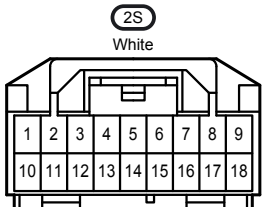
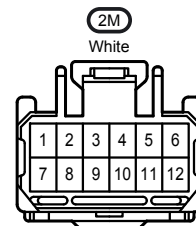
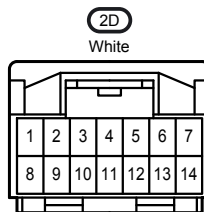
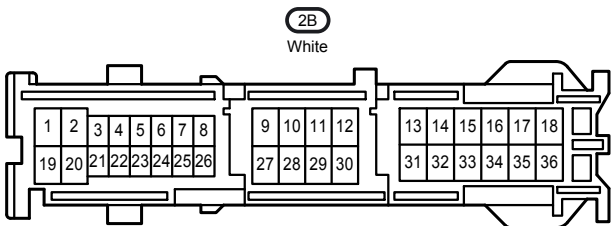
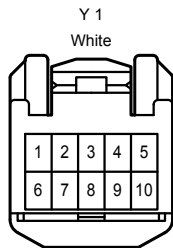
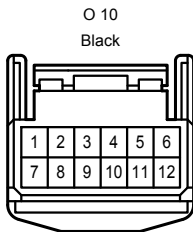
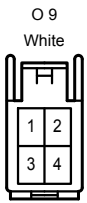
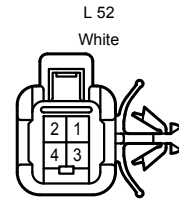
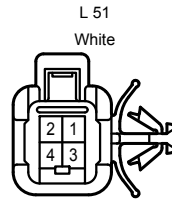
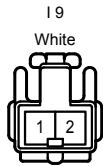
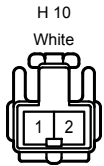
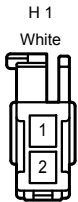
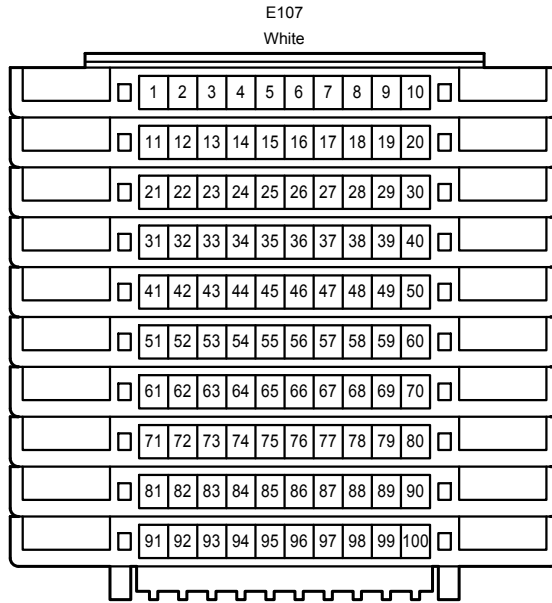
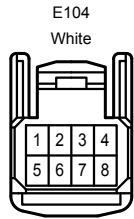
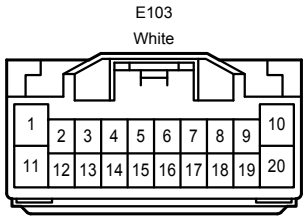

AE10  
Gray

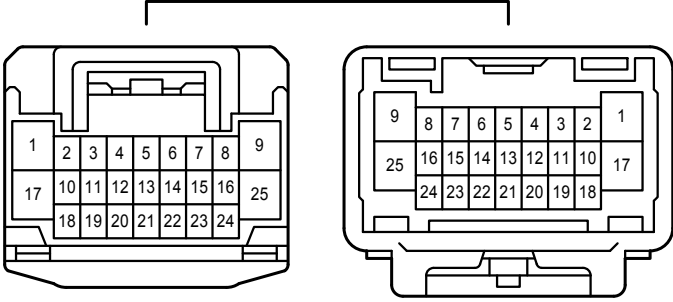

AE11  
White

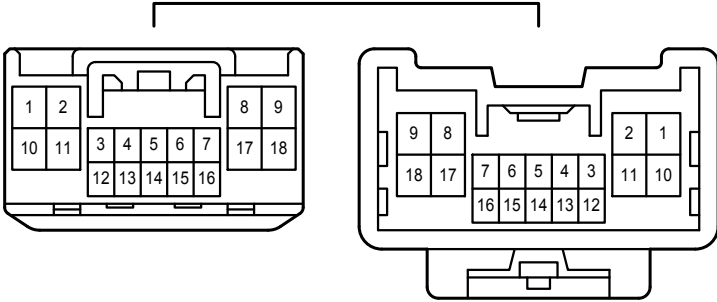

EL1  
White

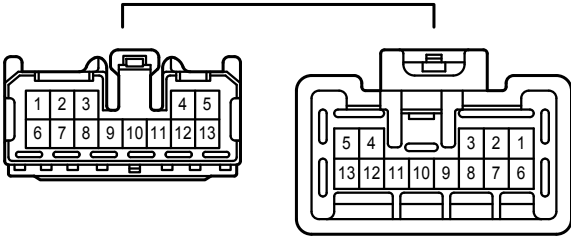

HE2  
White

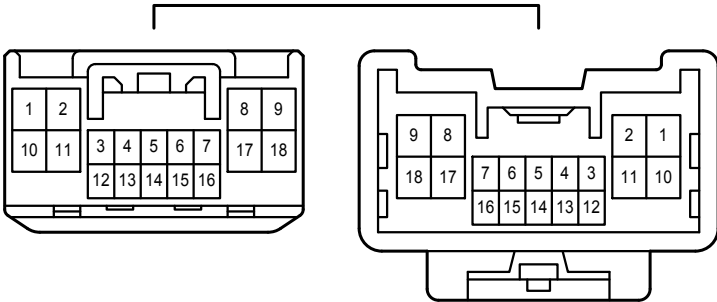

IE2  
White

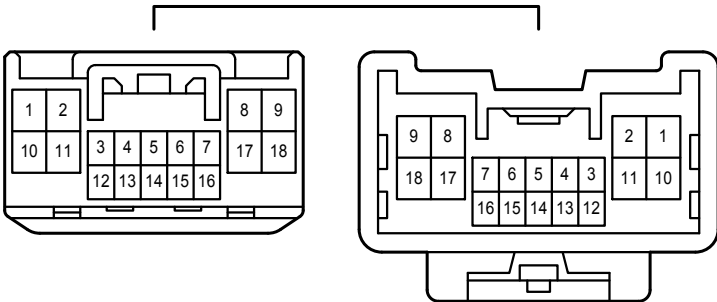

OE1  
White

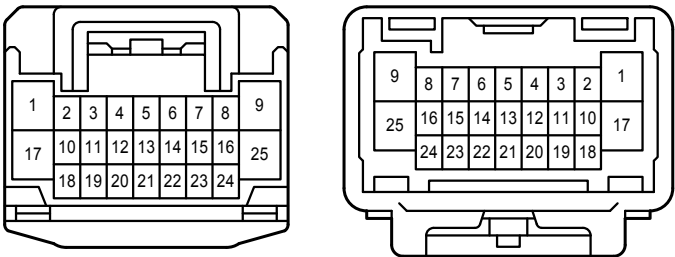

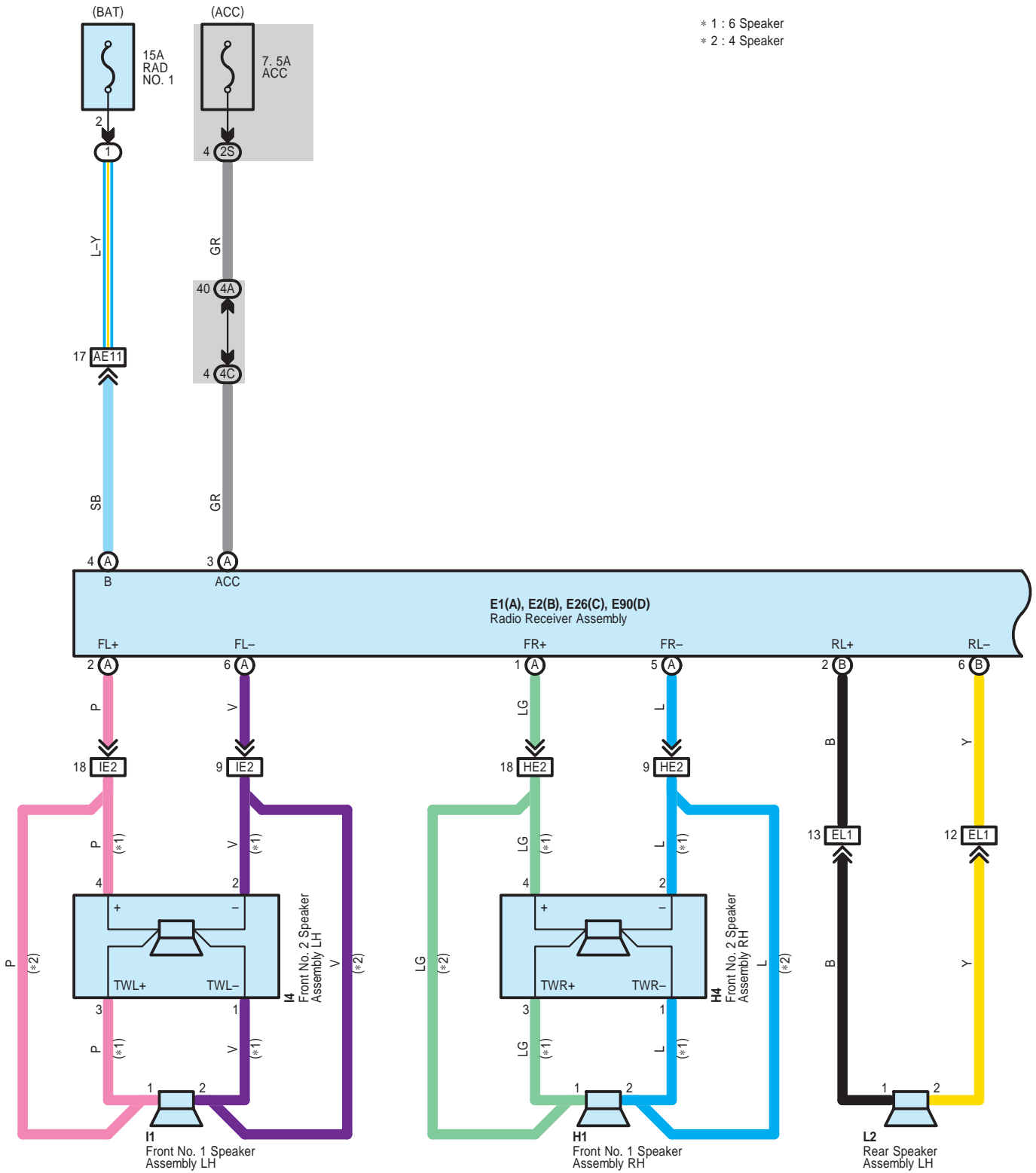

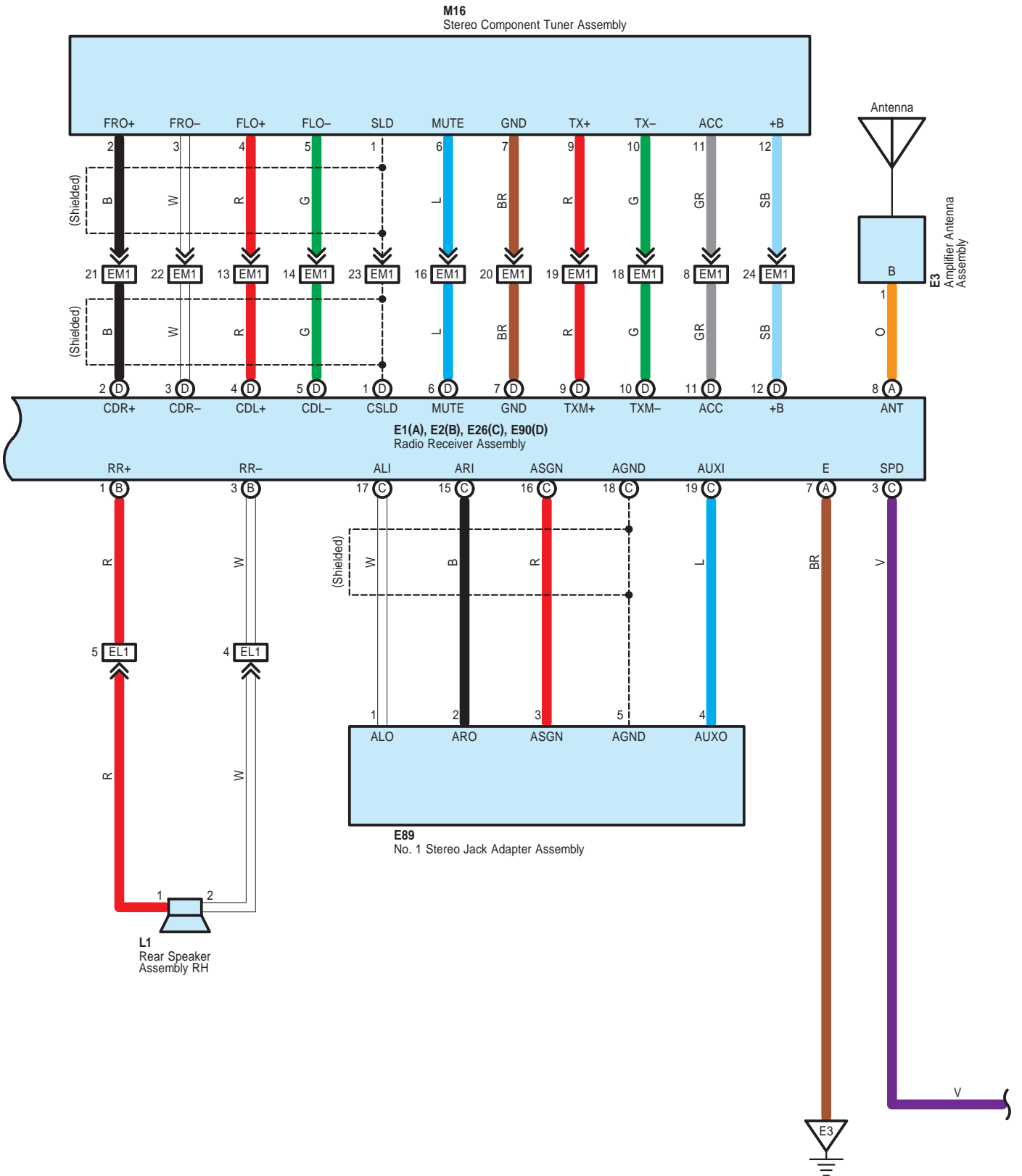



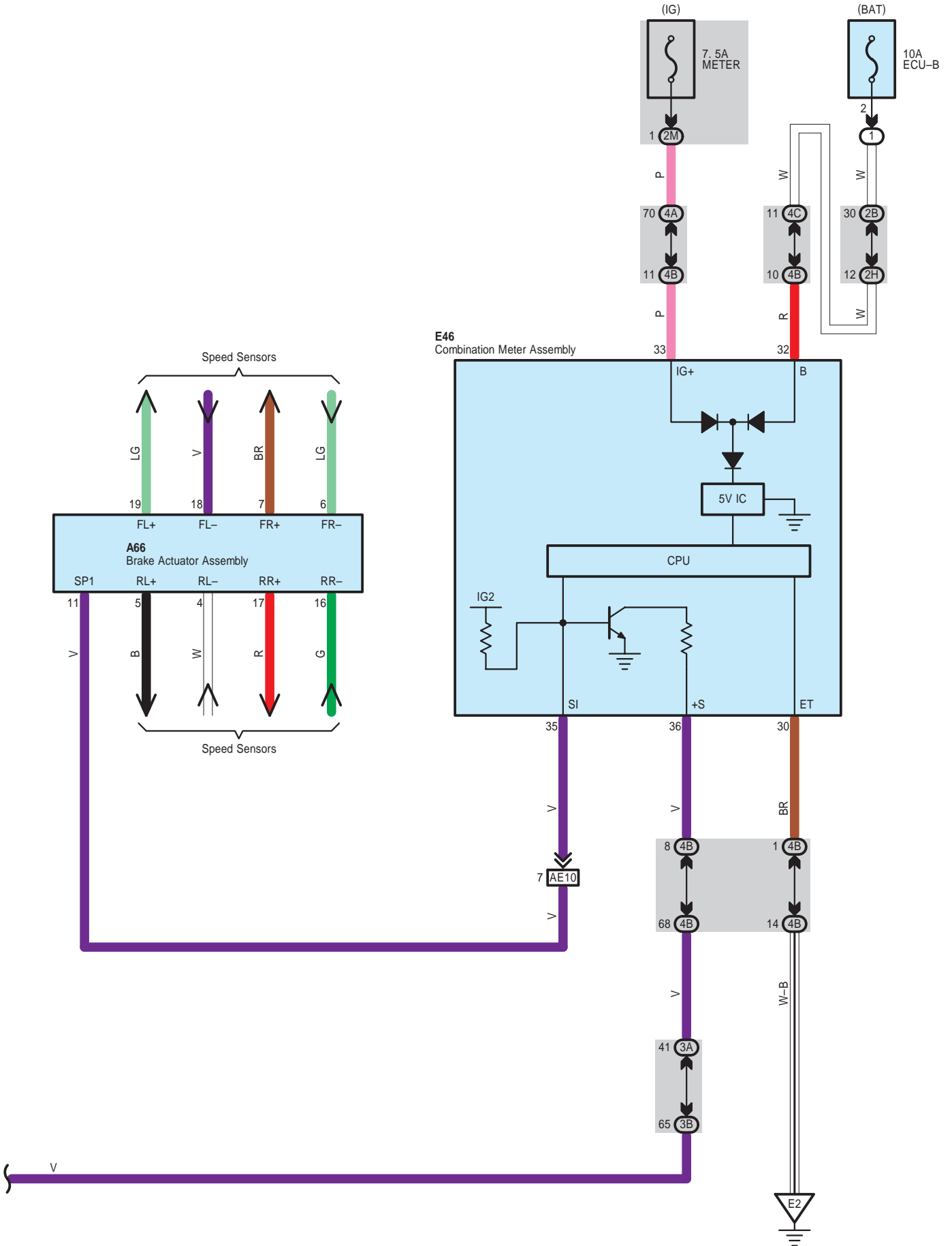

A 66  
Black

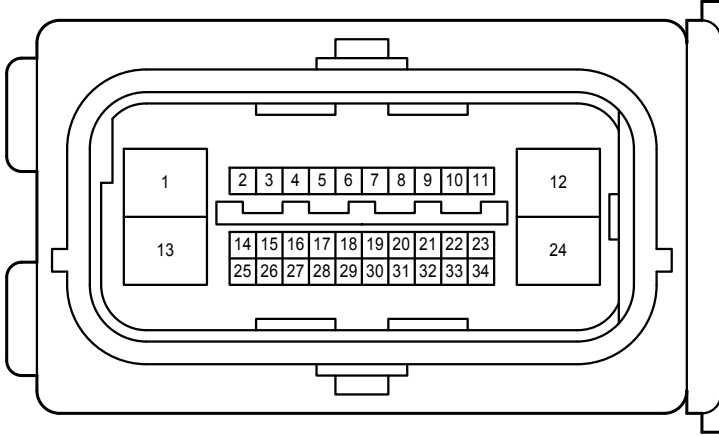

E 1  
White

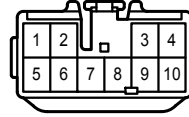

E 2  
White

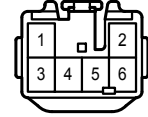

E 3  
White



E 26  
White

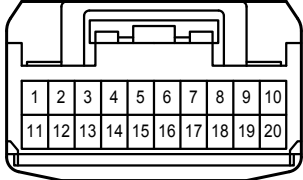

E 46  
White

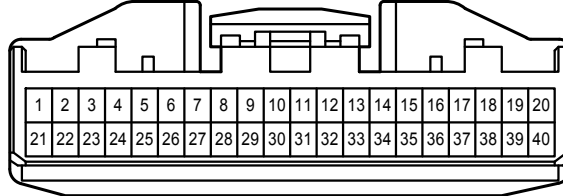

E 89  
White

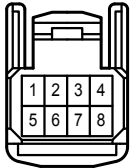

E 90  
White

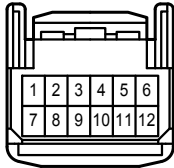

H 1  
White



H 4  
White

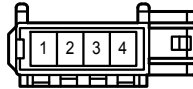

I 1  
White



I 4  
White



L 1  
White

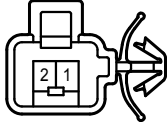

L 2  
White

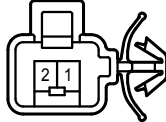

M 16  
White

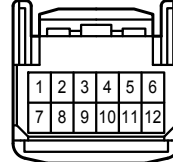

2B  
White

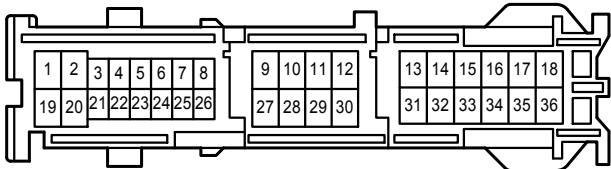

2H  
White

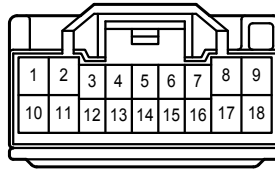

2M  
White

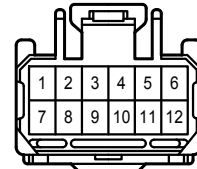

2S

White

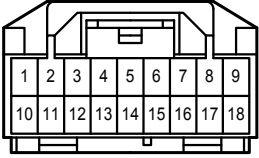

3A

White

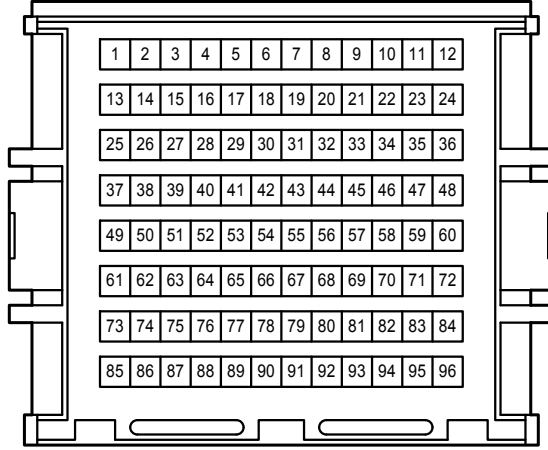

3B

White

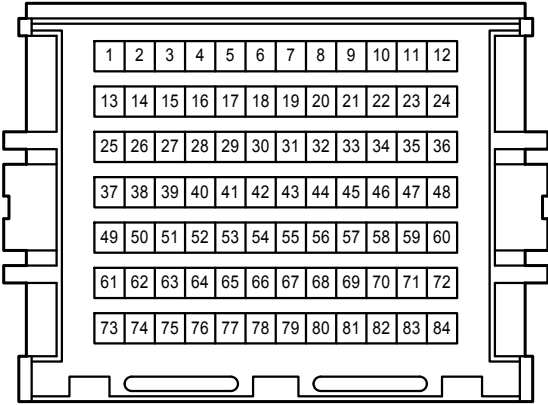

4A

White

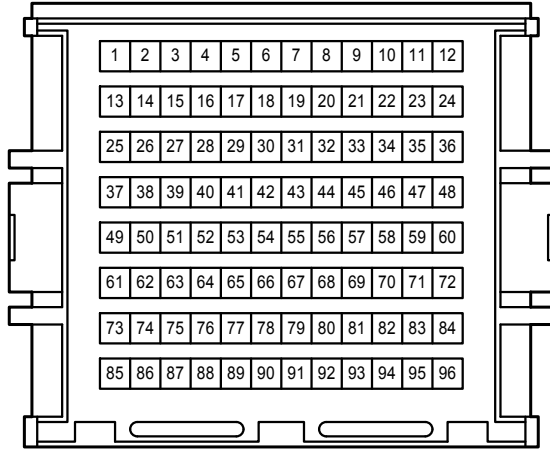

4B

White

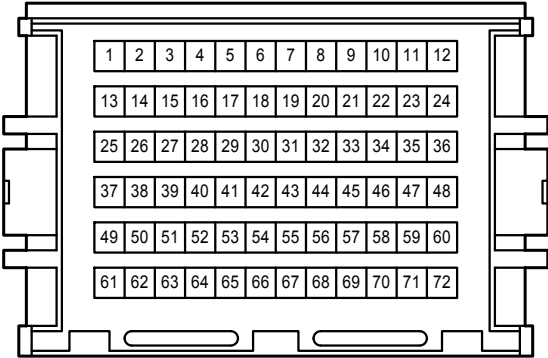

4C

White

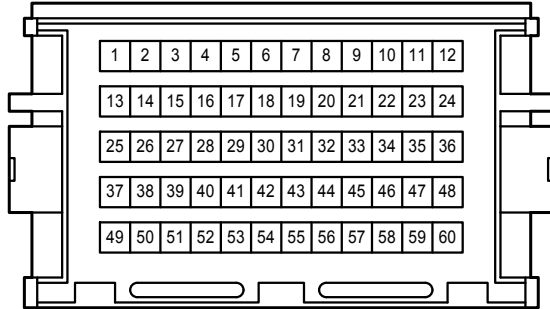

AE10  
Gray

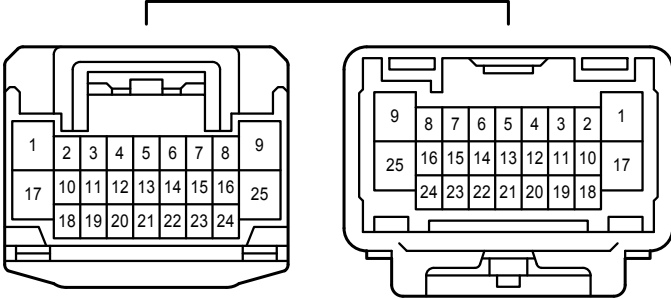

AE11  
White

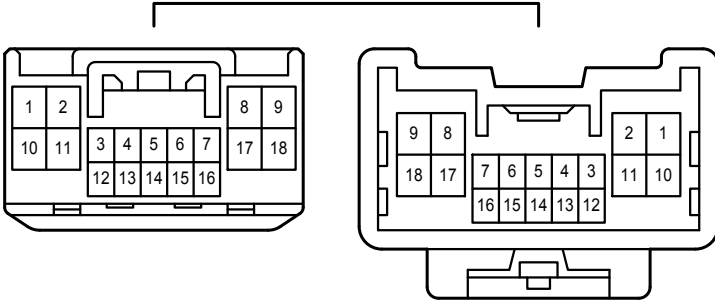

EL1  
White

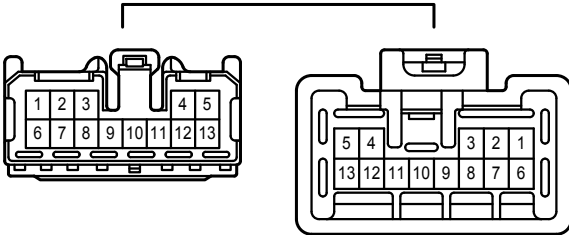

EM1  
Gray

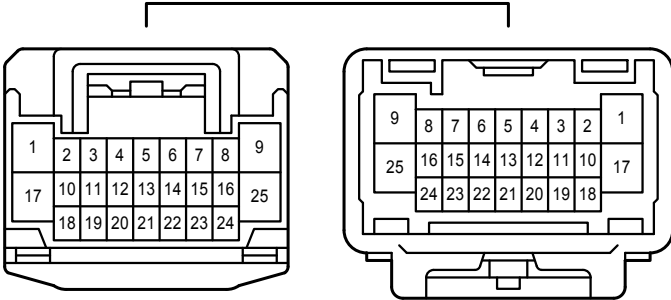

HE2  
White

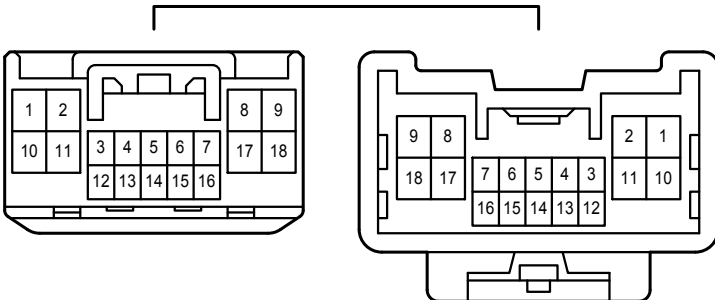

IE2  
White

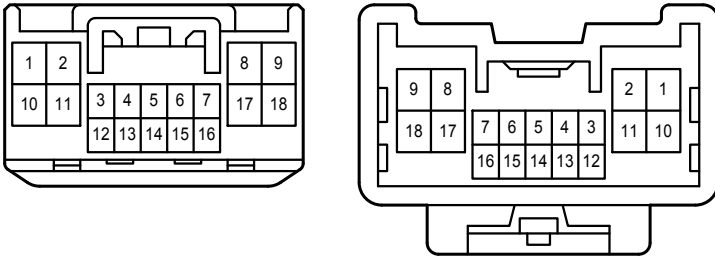

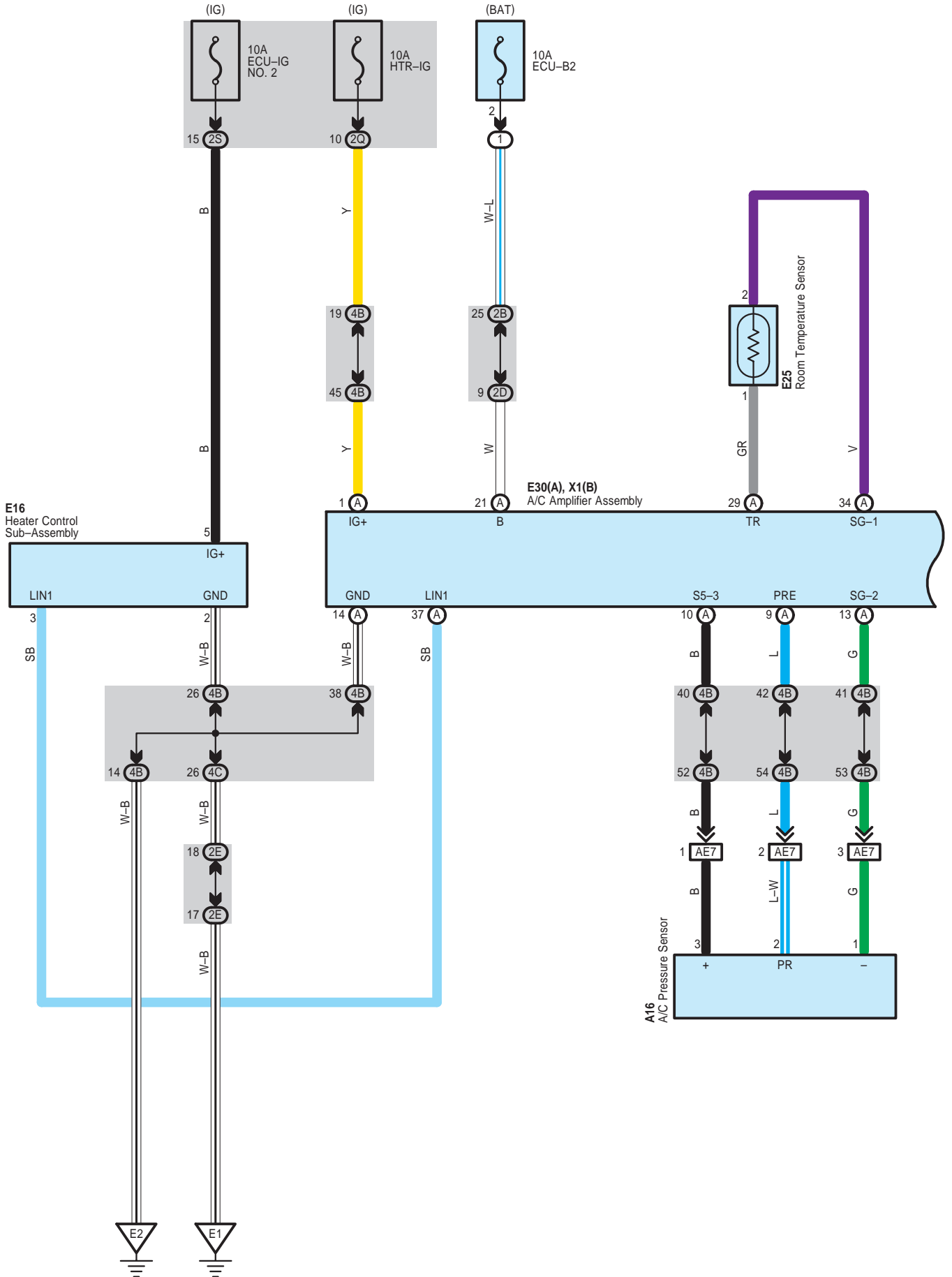

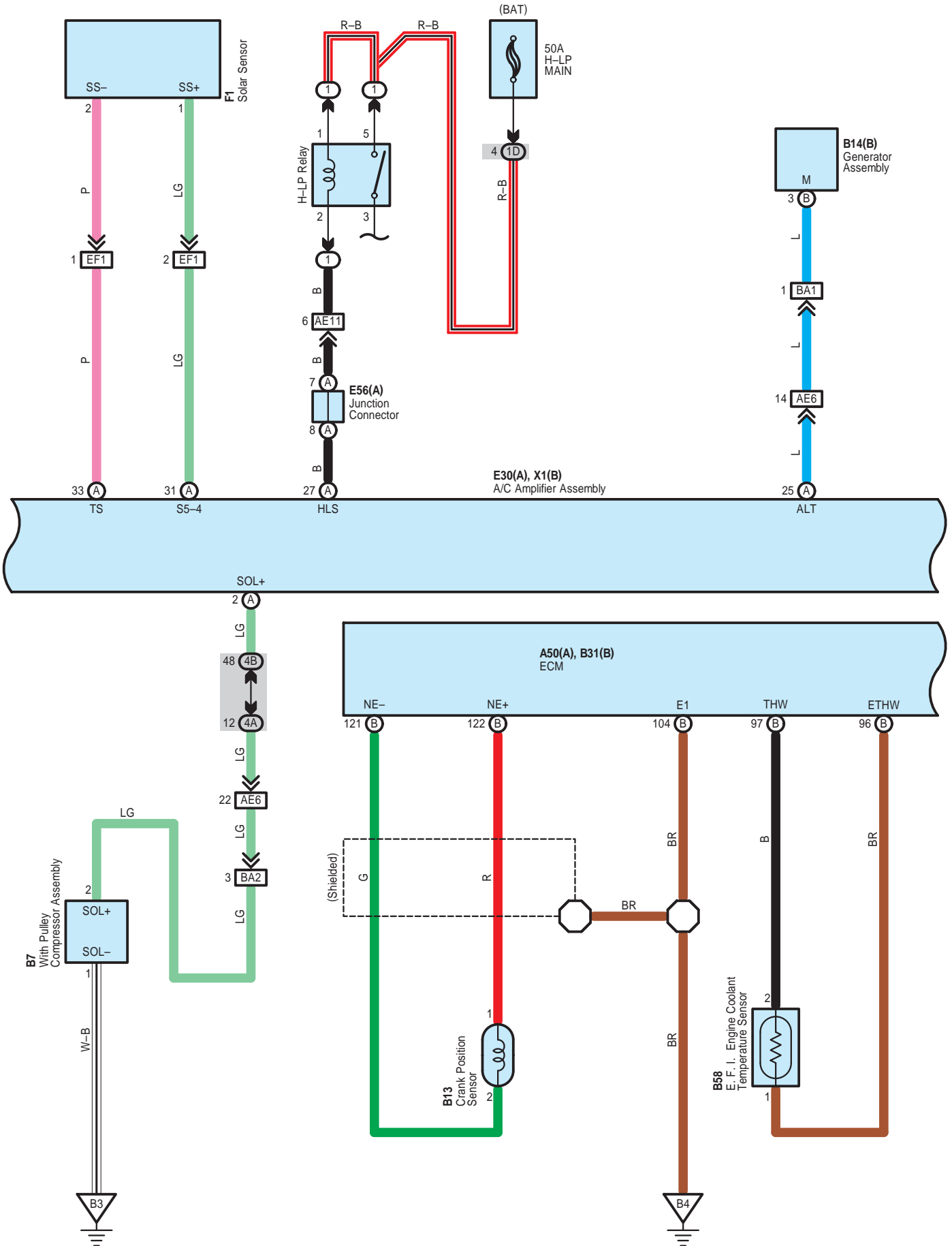

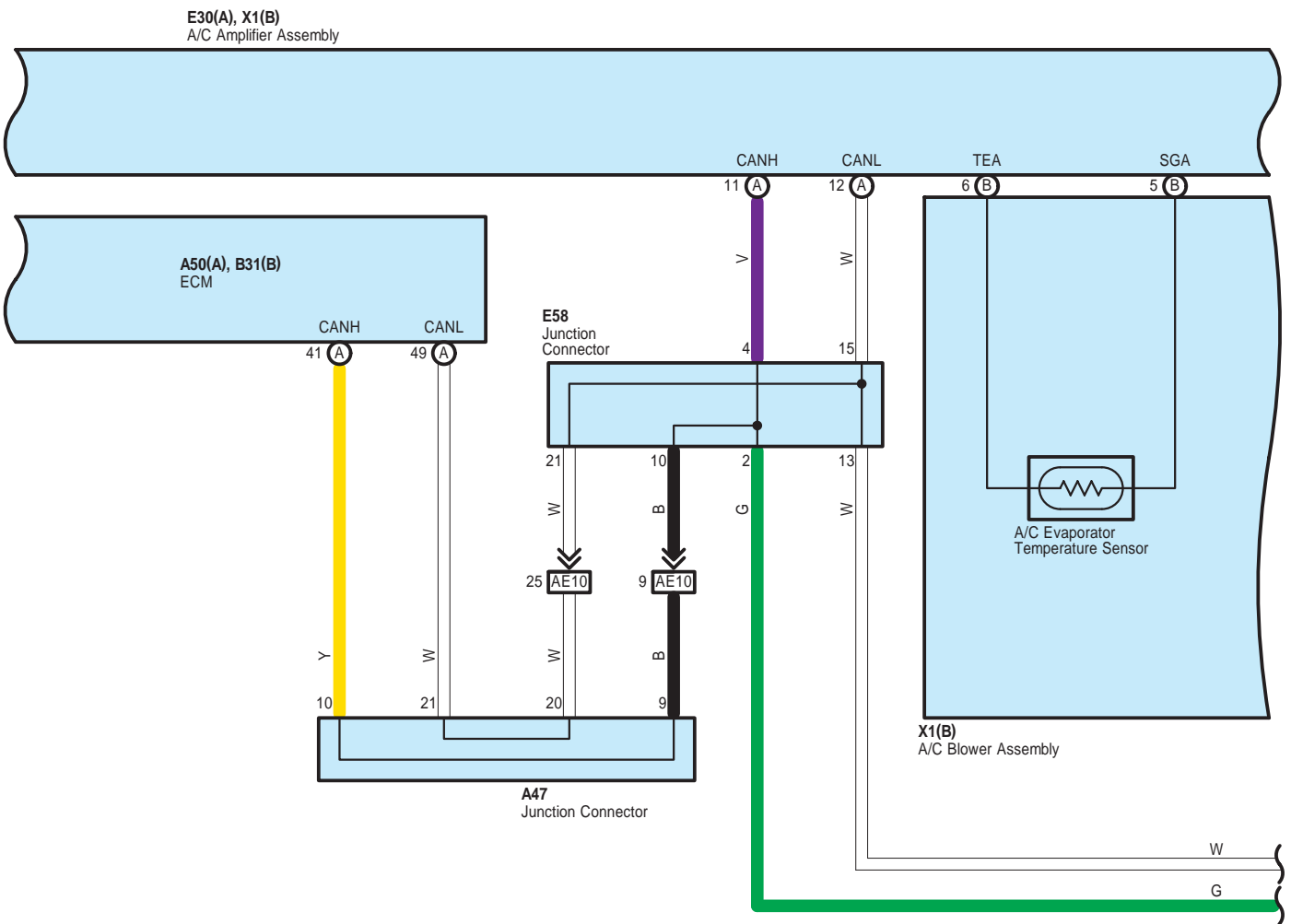



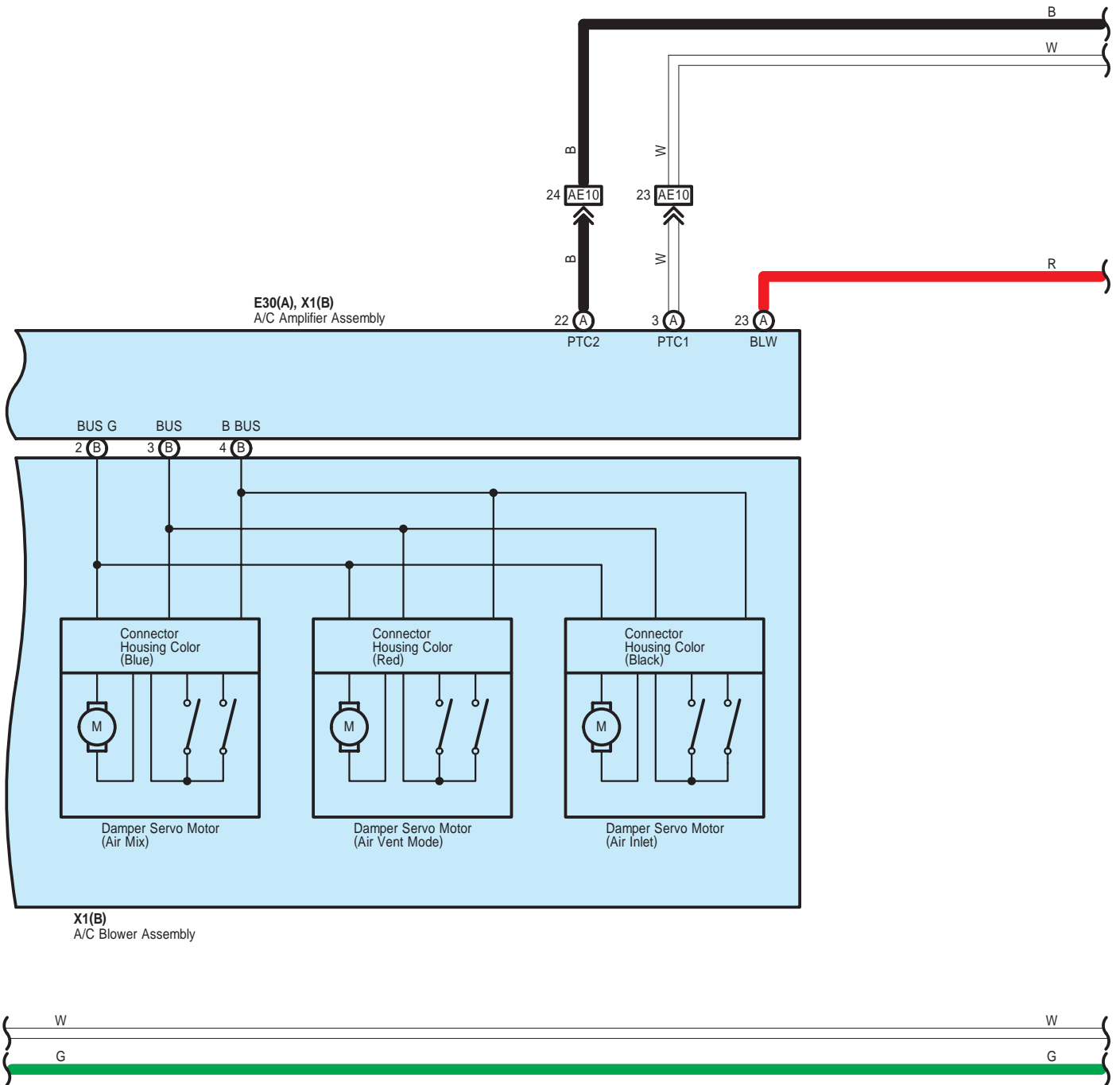

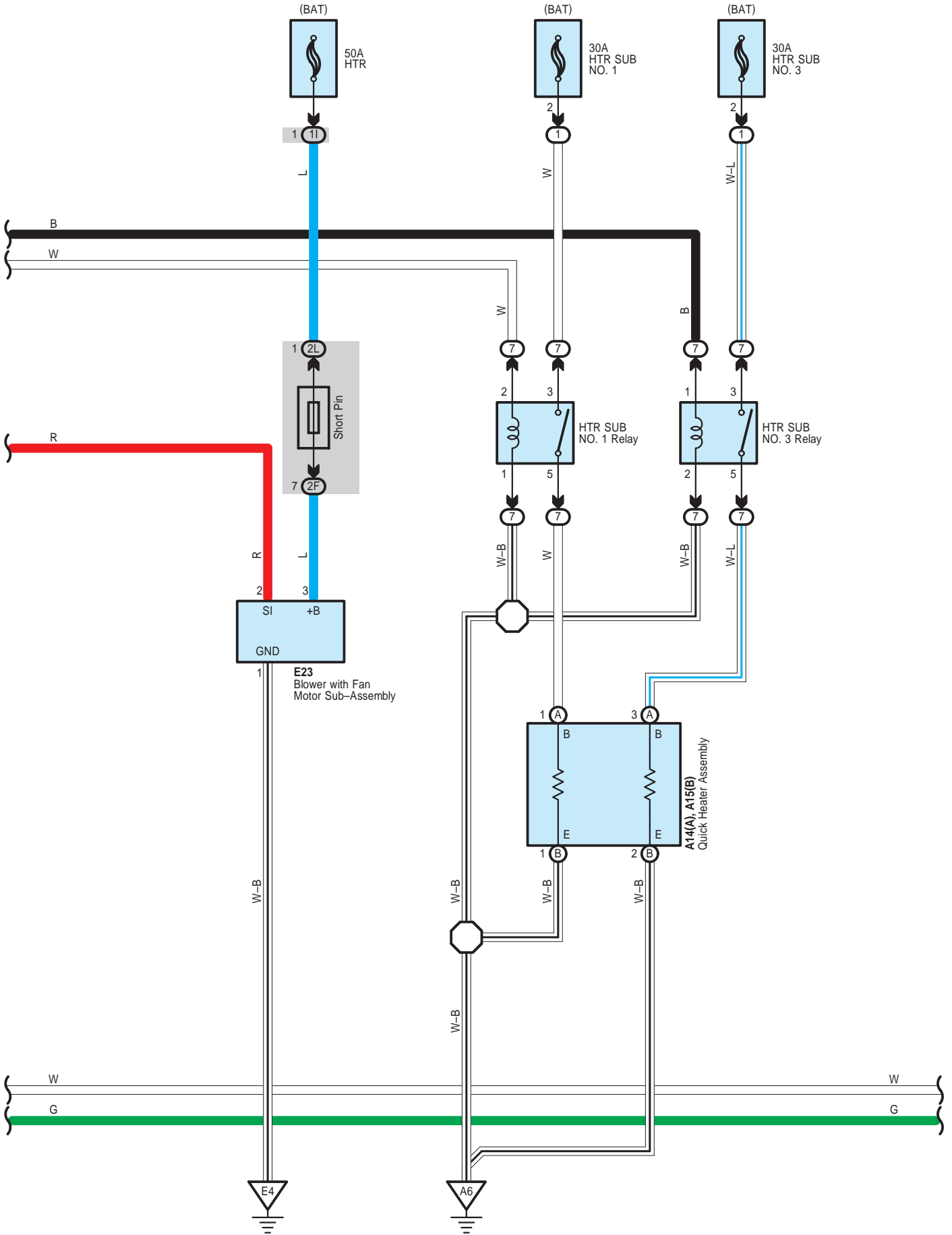

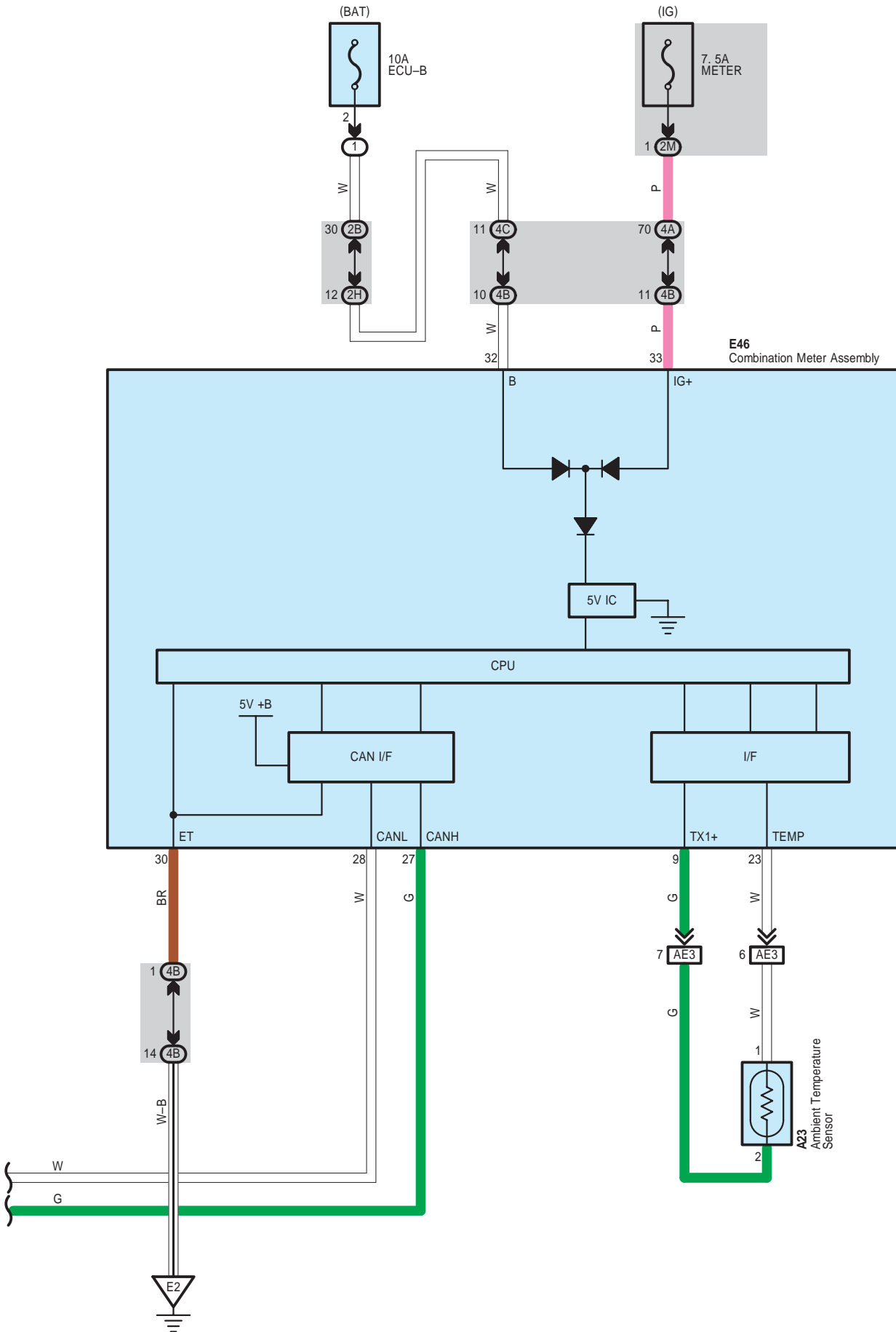



E 46  
White

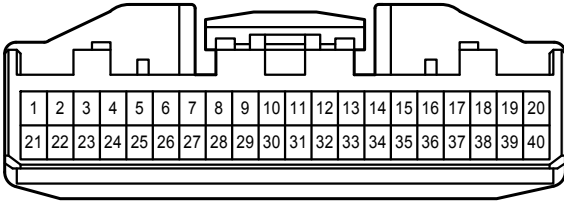

E 56  
White

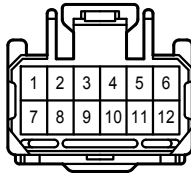

E 58  
Gray

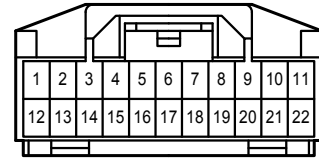

F 1  
Black



X 1  
White

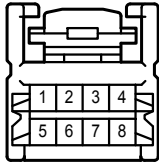

1D  
White

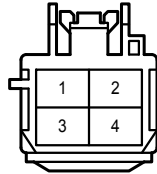

1I

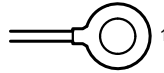

2B  
White

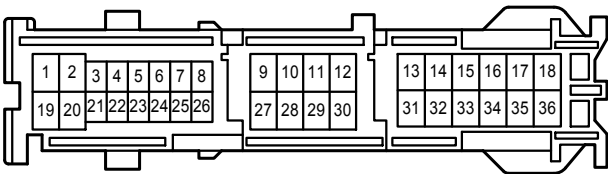

2D  
White

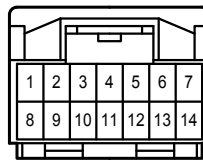

2E  
White

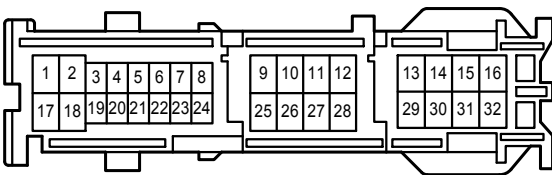

2F  
White

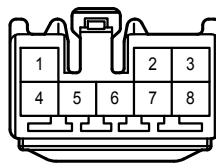

2H  
White

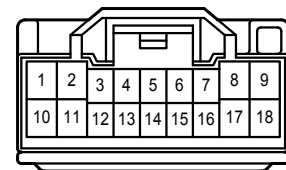

2L  
White

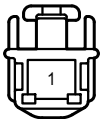

2M  
White

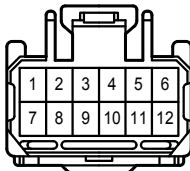

2Q  
White

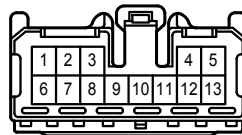

2S  
White

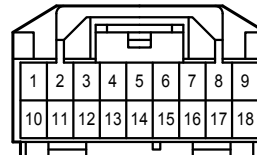

4A  
White

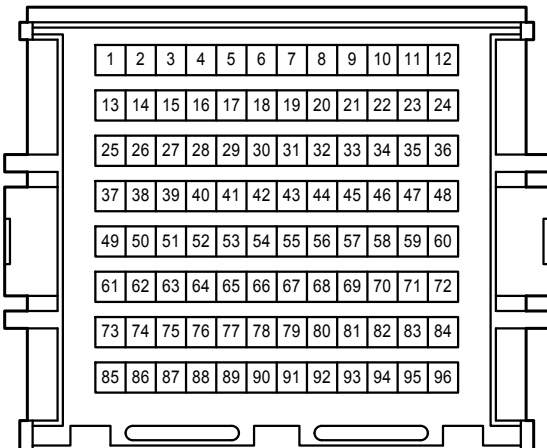

4B  
White

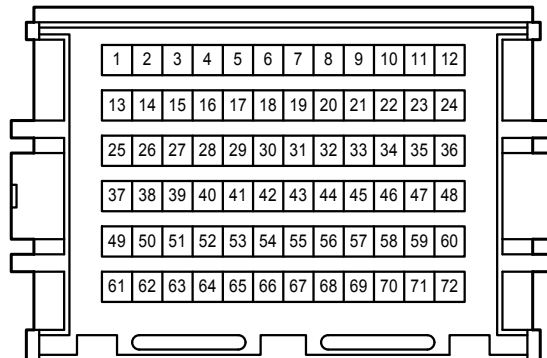

4C  
White

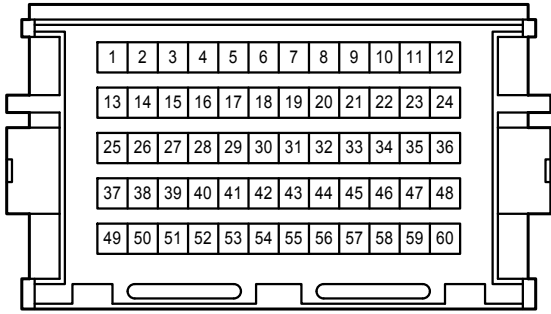

AE3  
White

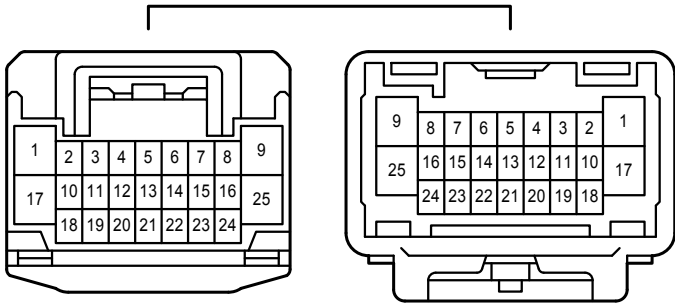

AE6  
Gray

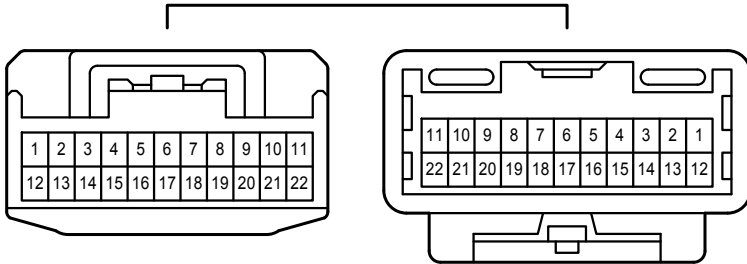

AE7  
Blue

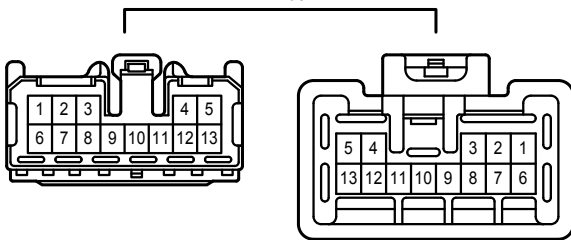

AE10  
Gray

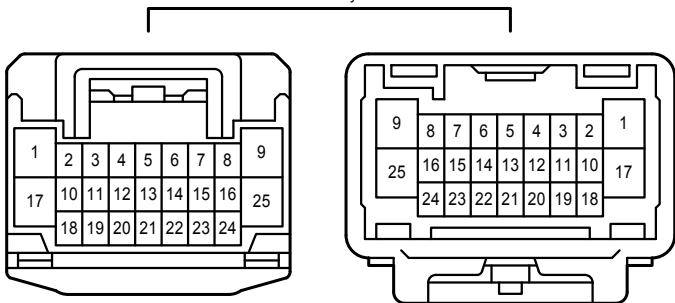

AE11  
White

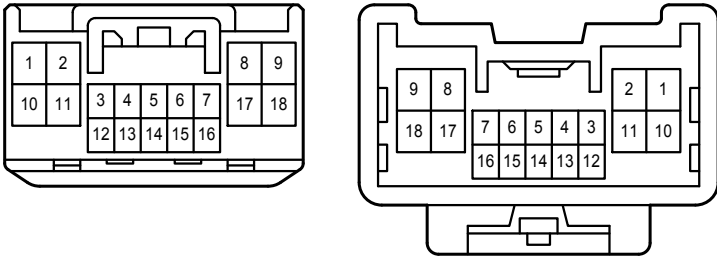

BA1  
White

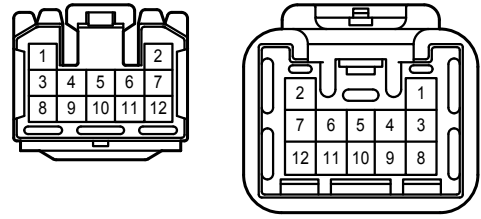

BA2  
White

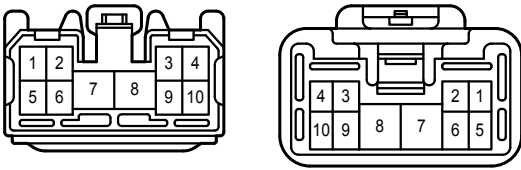

EF1  
White

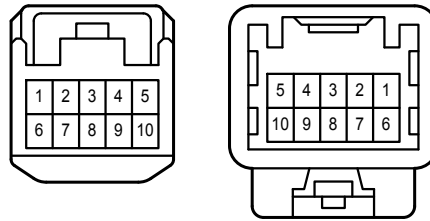

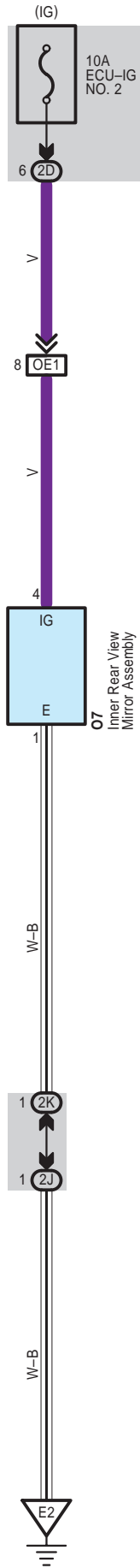



Automatic Glare-Resistant EC Mirror with Compass <Except TMC Made>

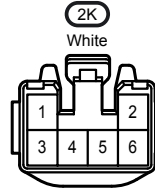
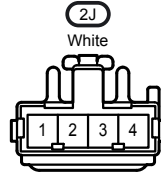
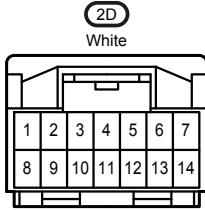
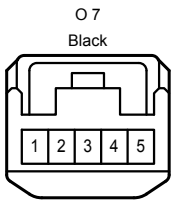

OE1  
White

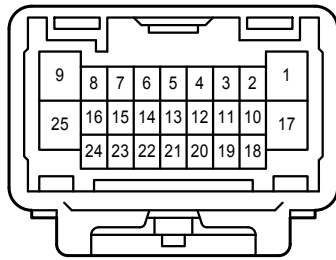
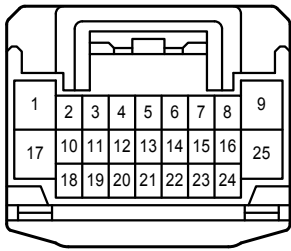

Back-Up Light <Except TMC Made>

- \* 1 : 2AZ-FE
- \* 2 : 2ZR-FE

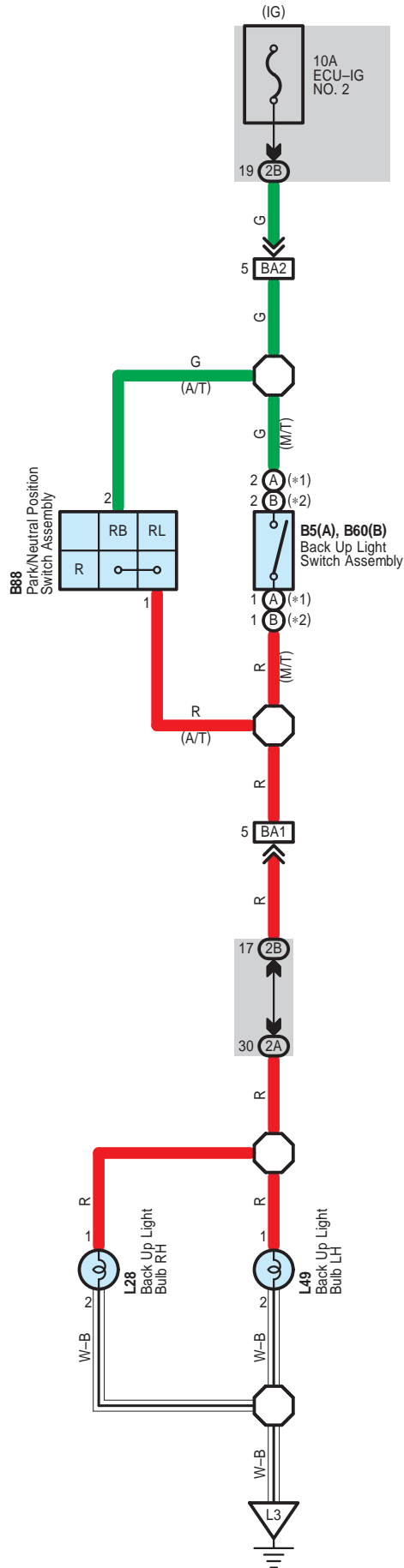

Back-Up Light <Except TMC Made>

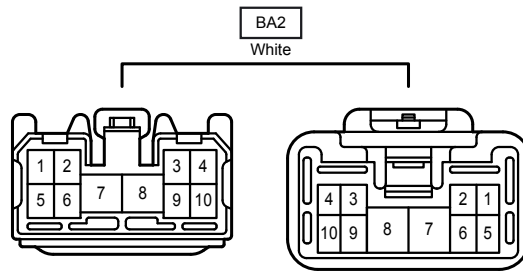
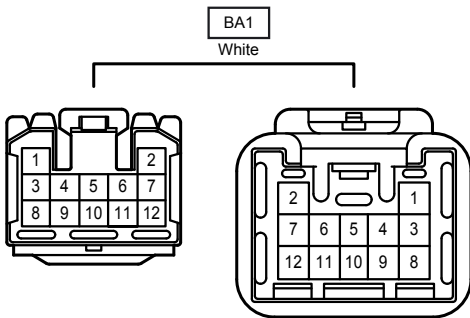
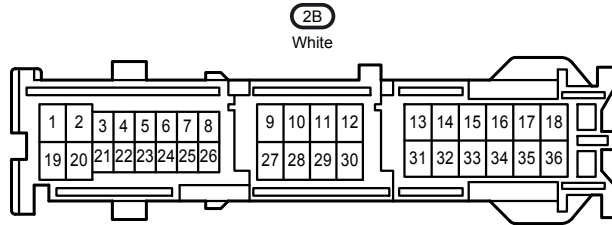
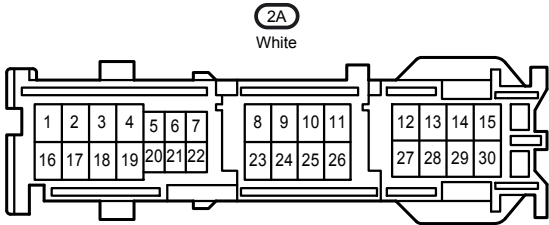
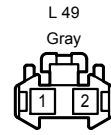
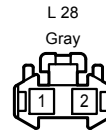
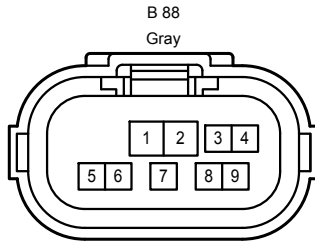
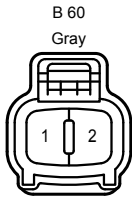
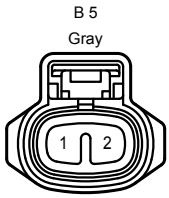

Back-Up Light <TMC Made>

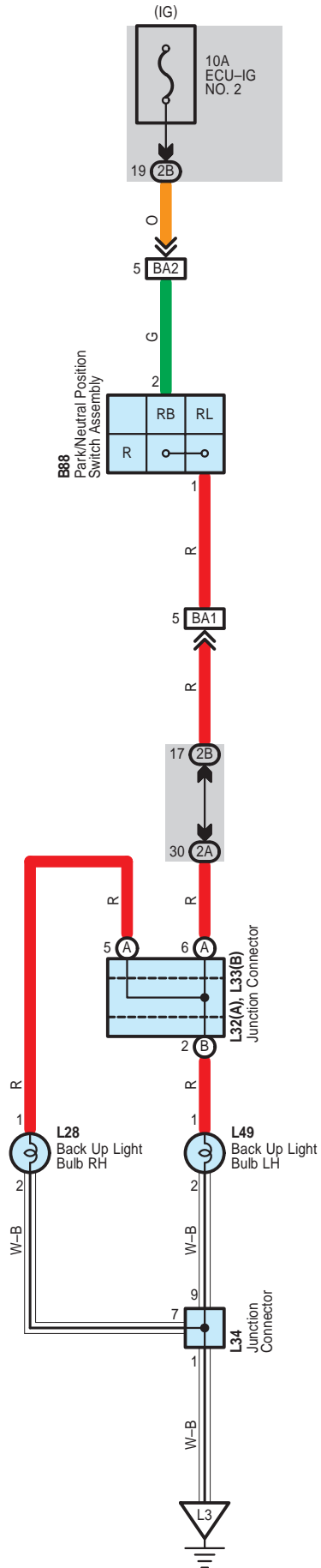

Back-Up Light <TMC Made>

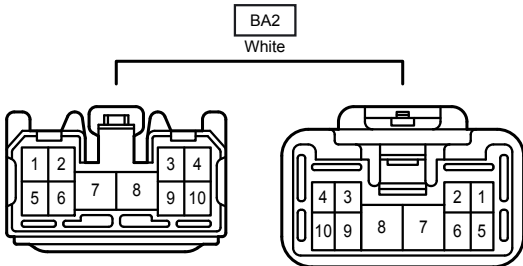
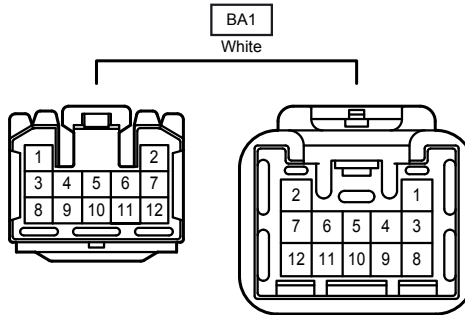
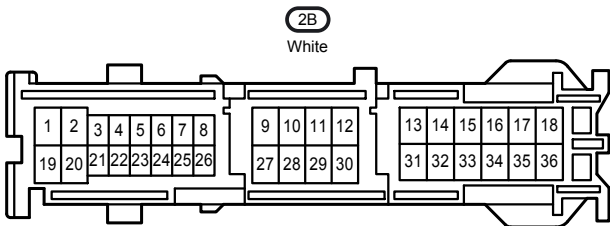
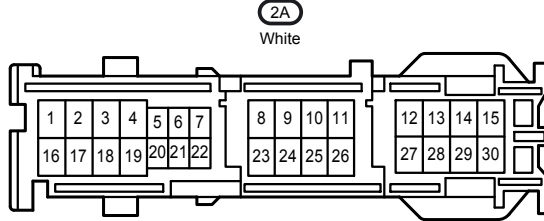
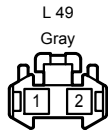
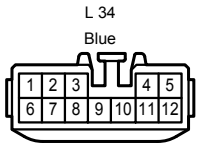
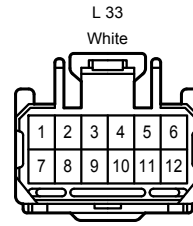
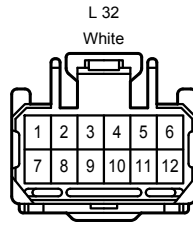
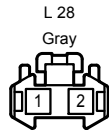
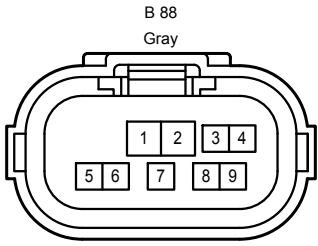

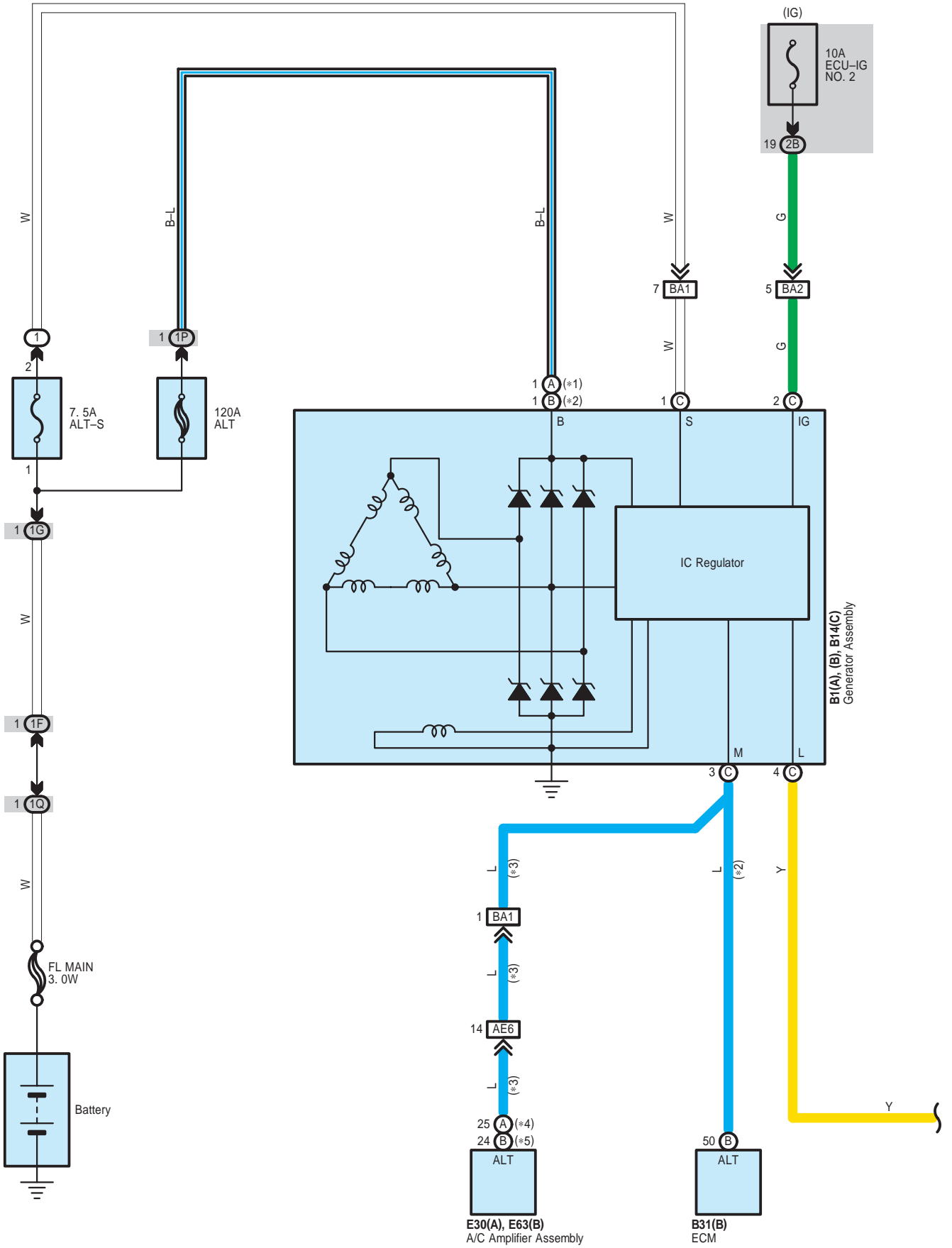

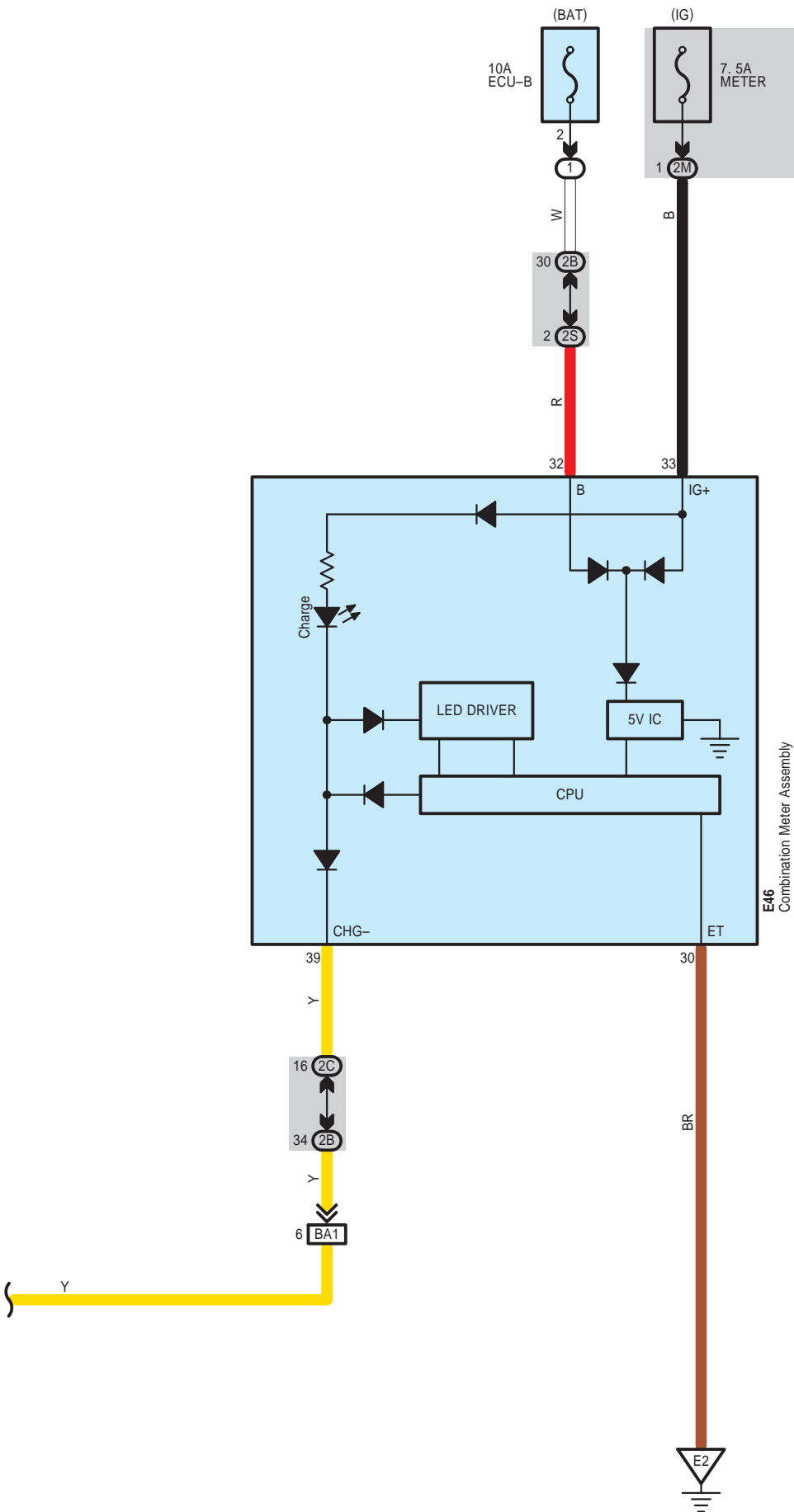

- \* 1 : 2ZR-FE
- \* 2 : 2AZ-FE
- \* 3 : w/ PTC Heater
- \* 4 : Automatic A/C
- \* 5 : Manual A/C

E46  
Combination Meter Assembly

**Charging <Except TMC Made>**

---

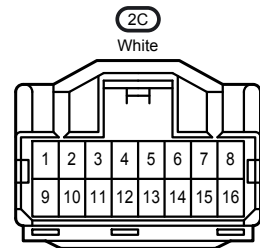
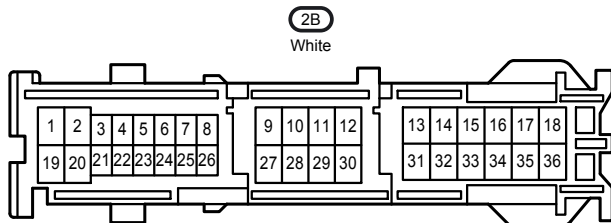
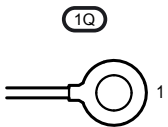
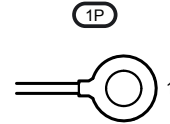
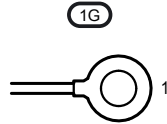
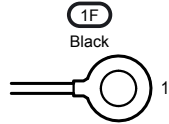
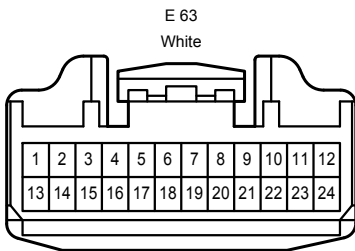
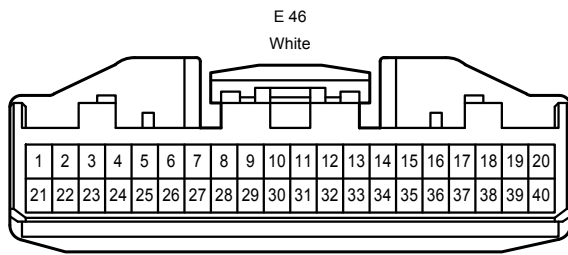
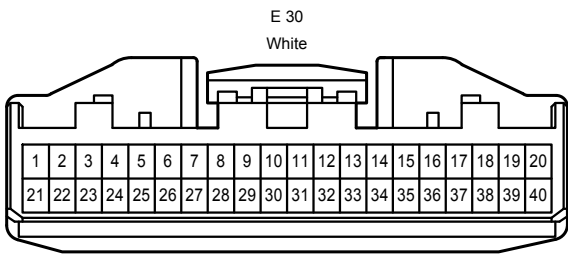
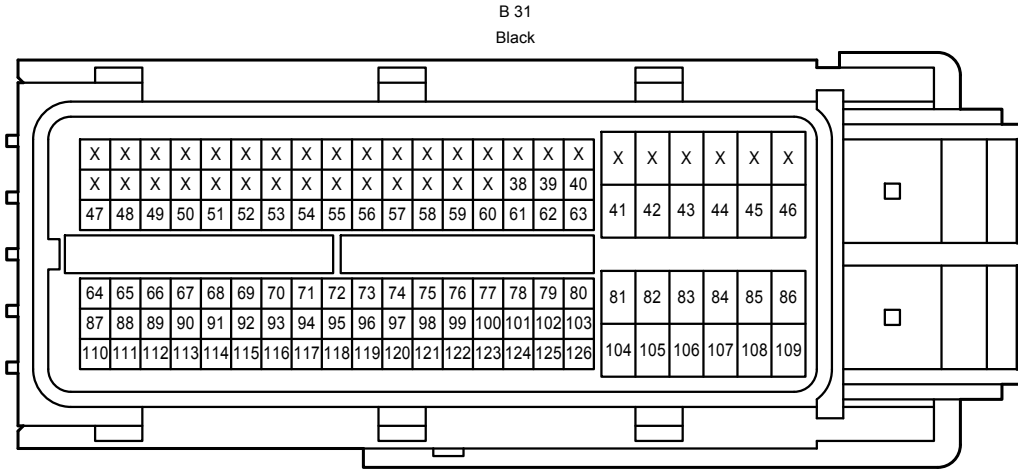
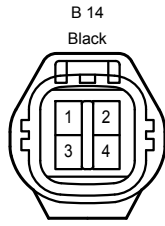
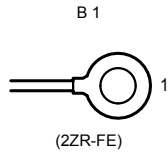
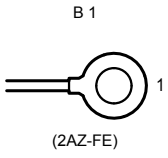



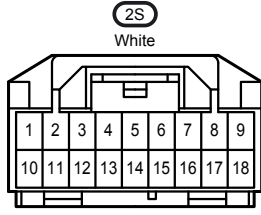
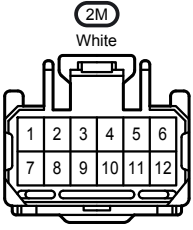

AE6  
Gray

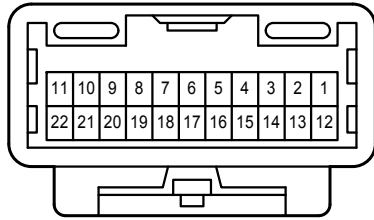
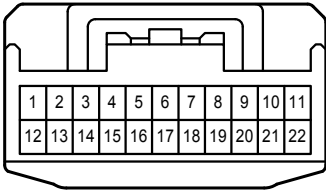

BA1  
White

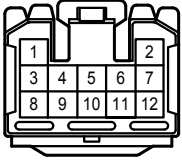

BA2  
White

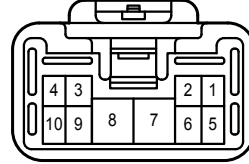
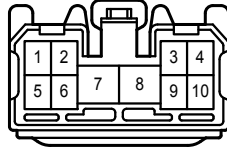

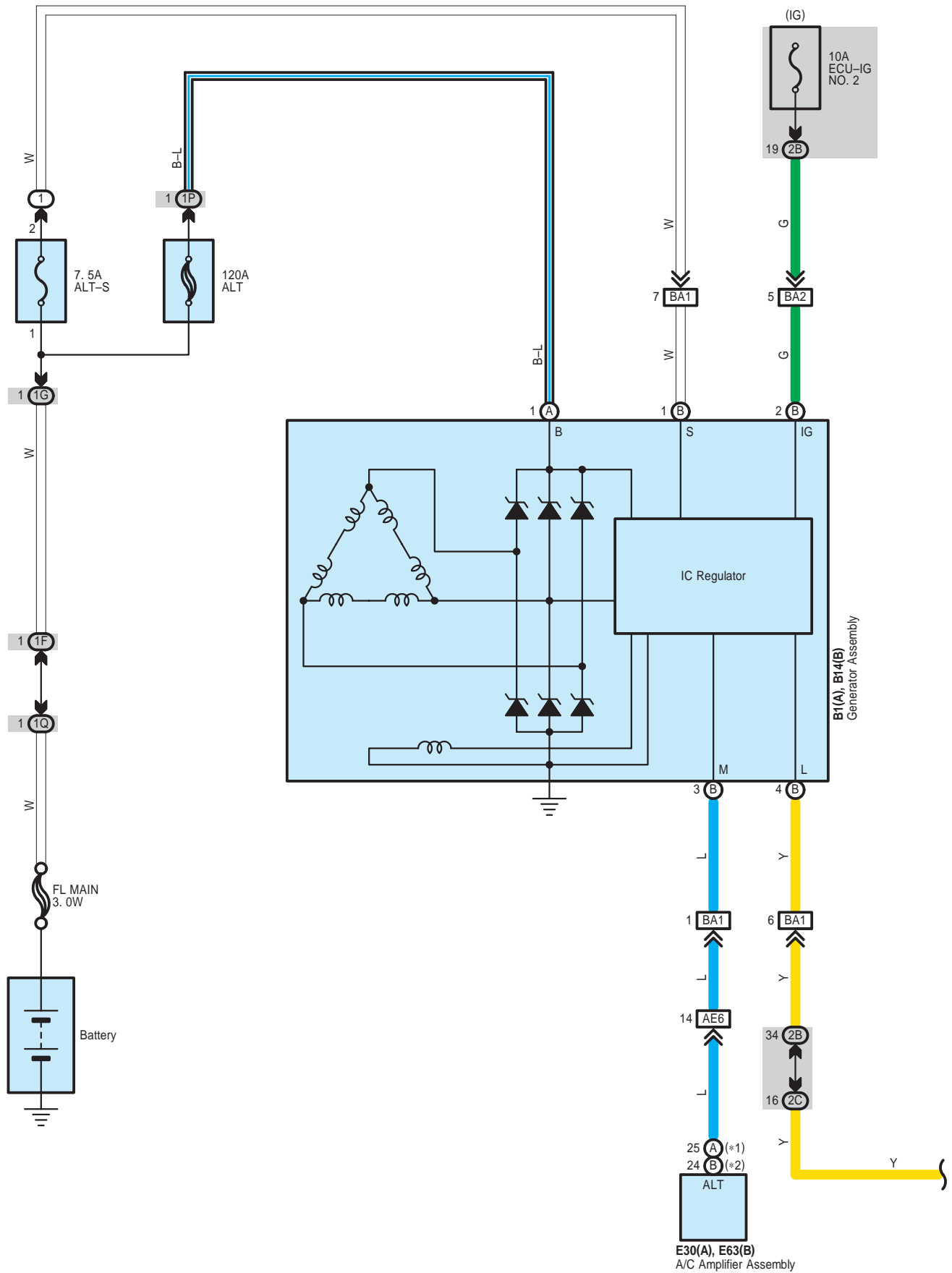

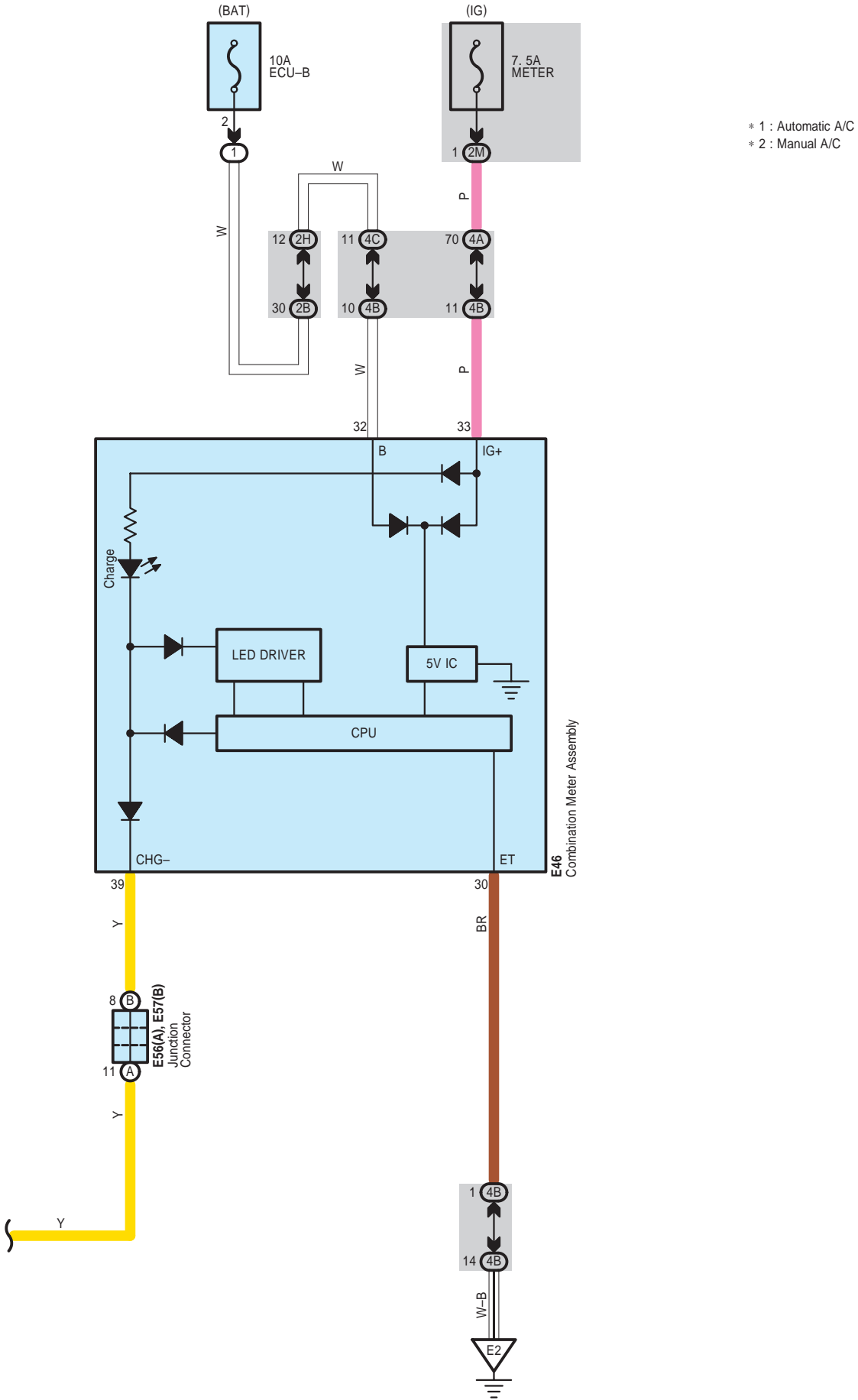

Charging <TMC Made>

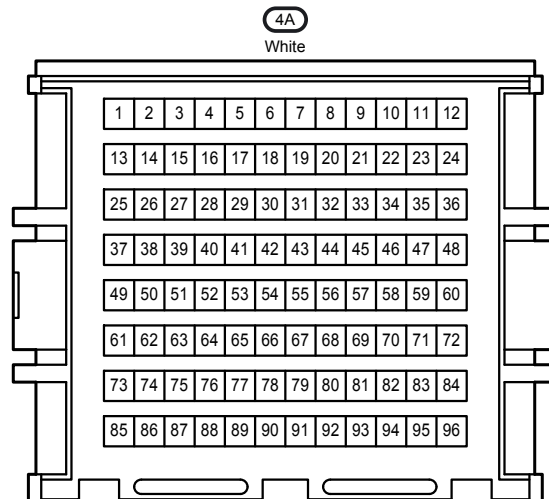
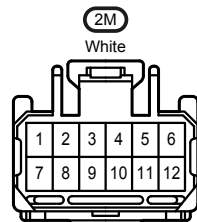
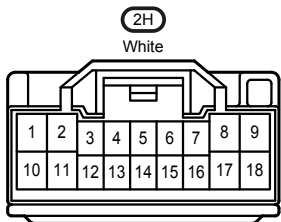
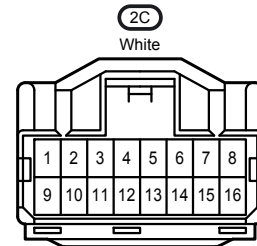
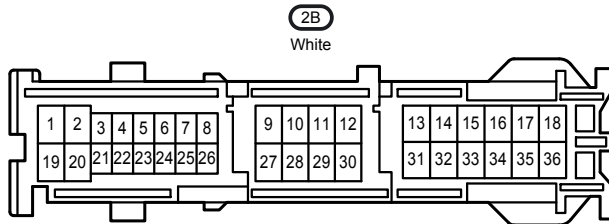
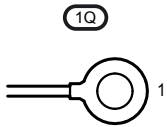
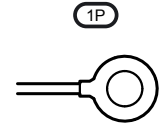
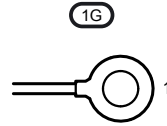
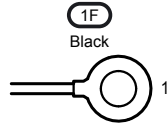
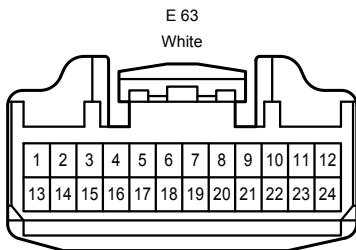
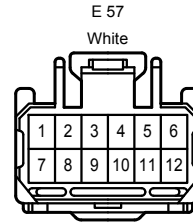
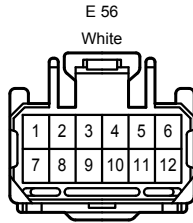
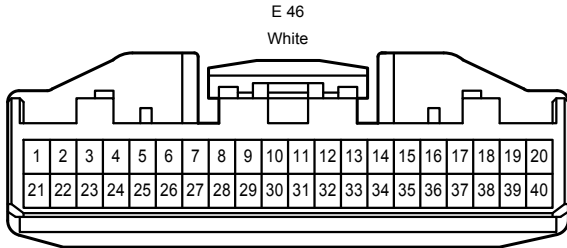
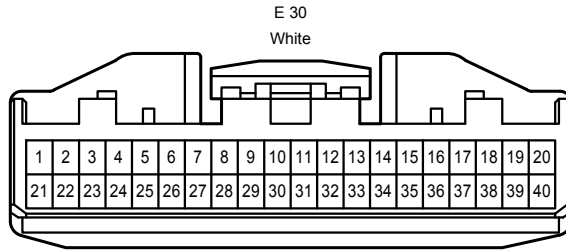
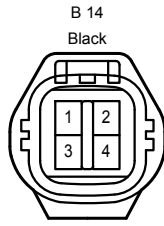
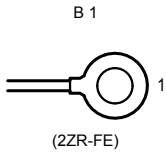

4B  
White

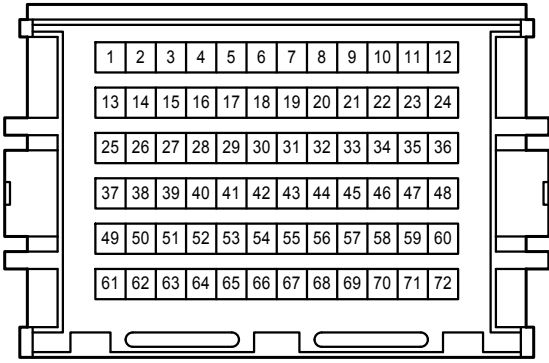

4C  
White

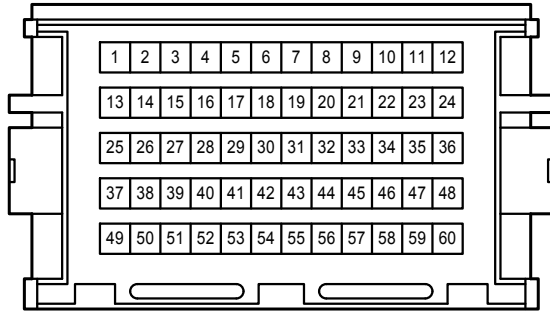

AE6  
Gray

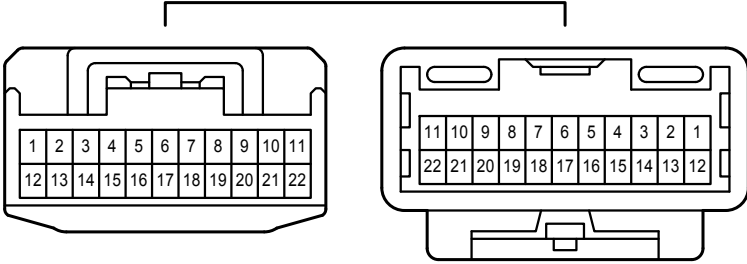

BA1  
White

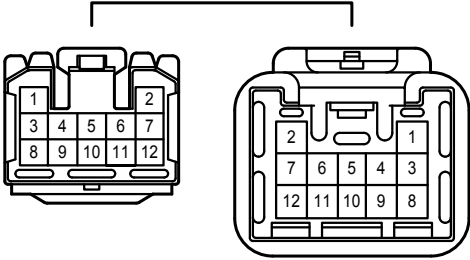

BA2  
White

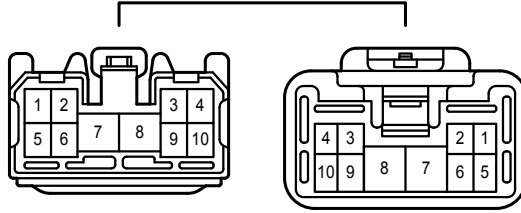

Cigarette Lighter <TMC Made>

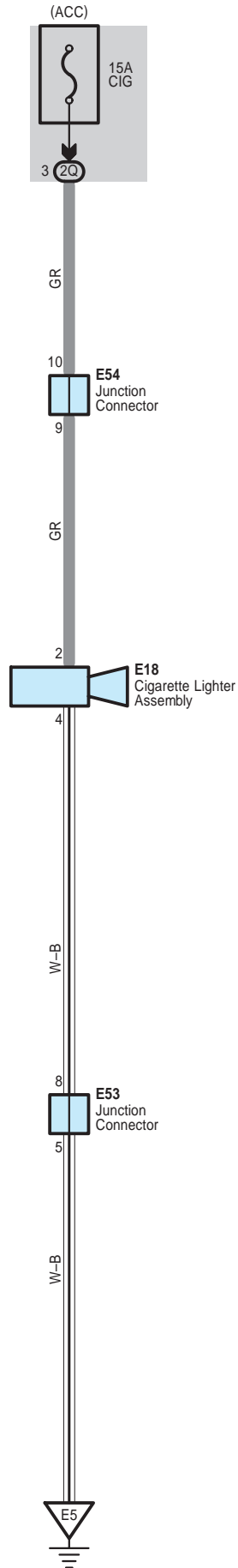

E 18

Blue

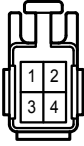

E 53

White

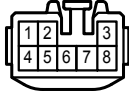

E 54

White

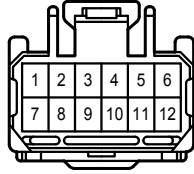

2Q

White

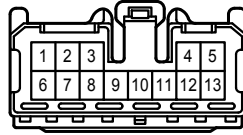

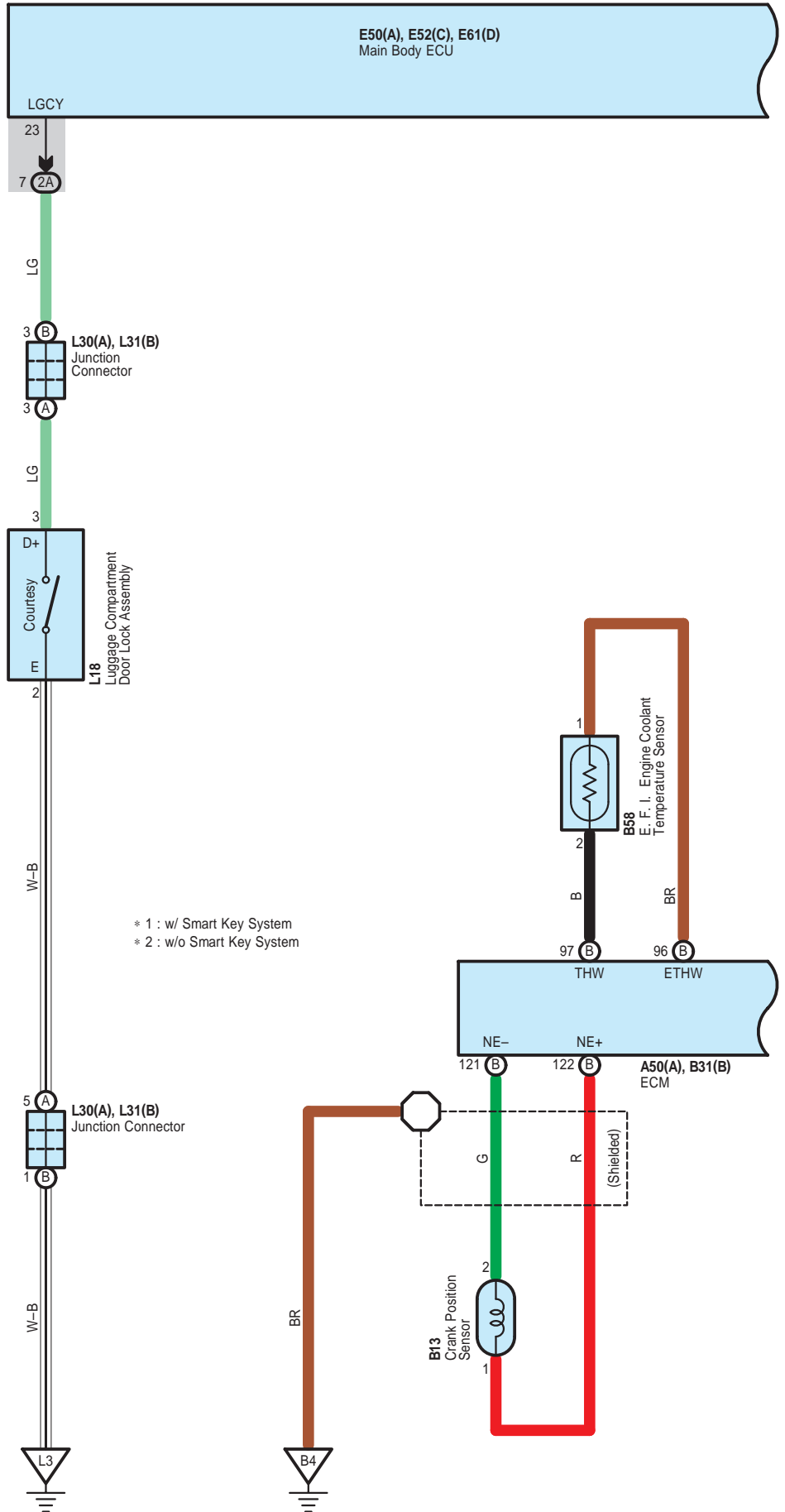



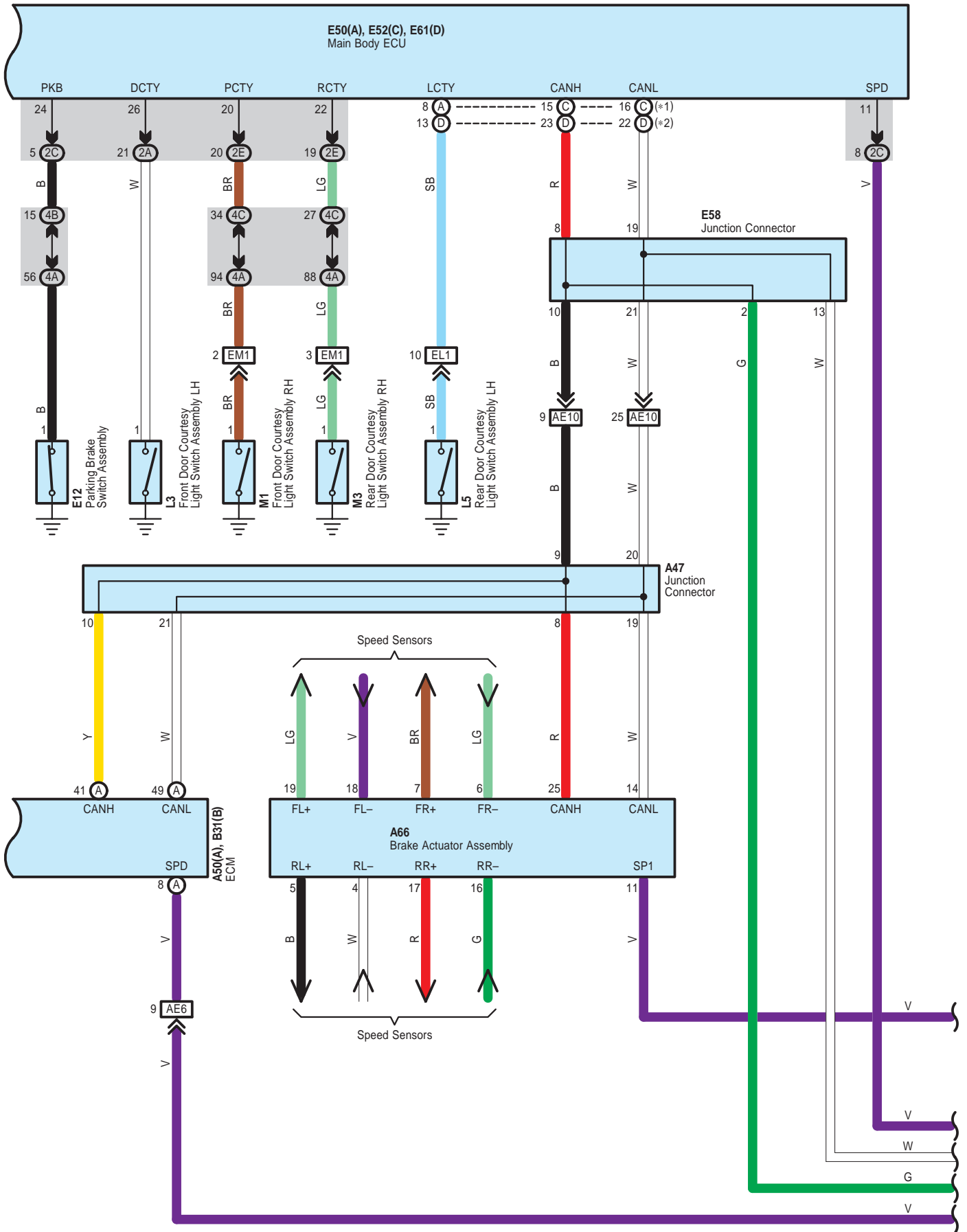

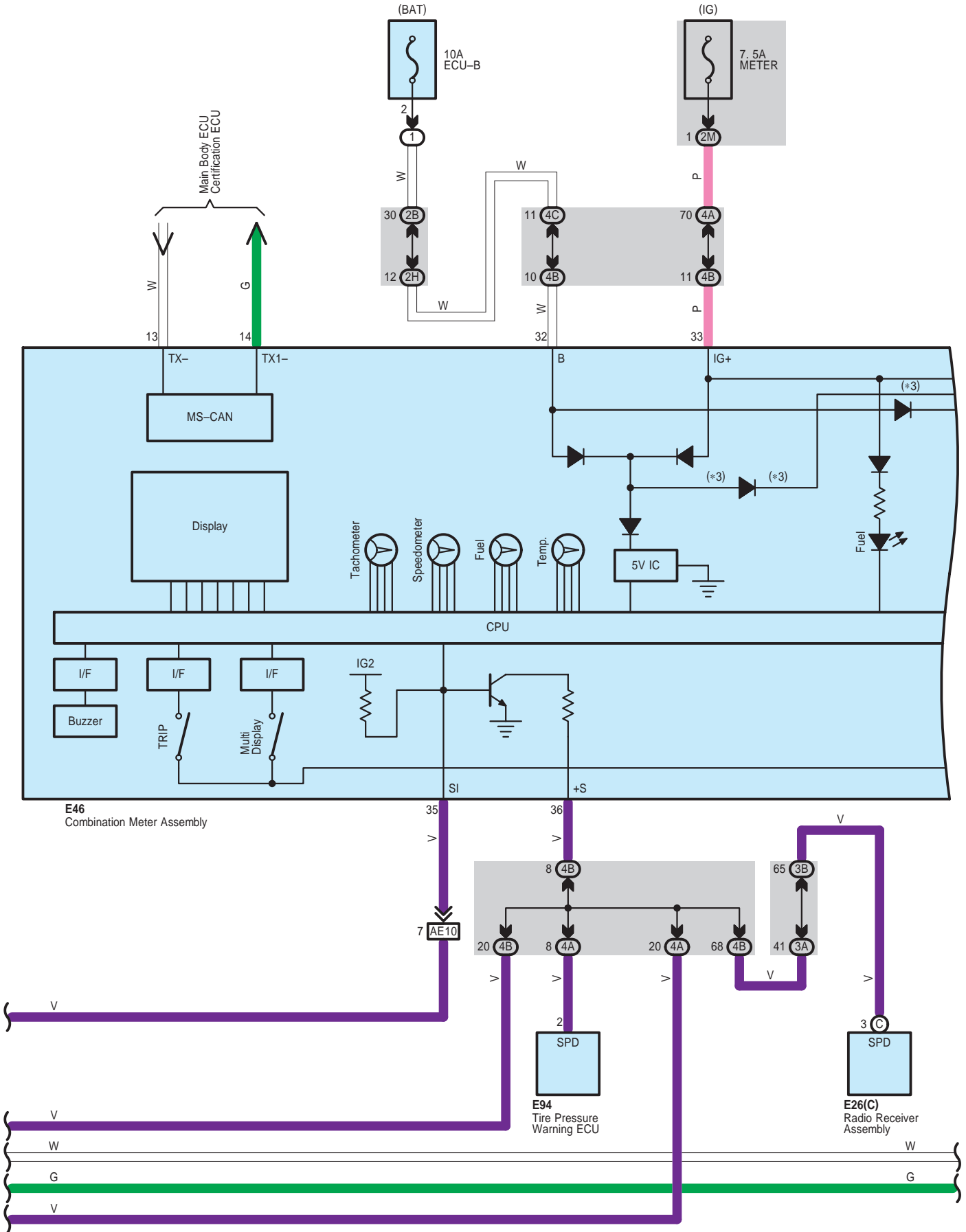

Combination Meter <TMC Made>

- \* 3 : Optitron Meter
- \* 4 : Except Optitron Meter

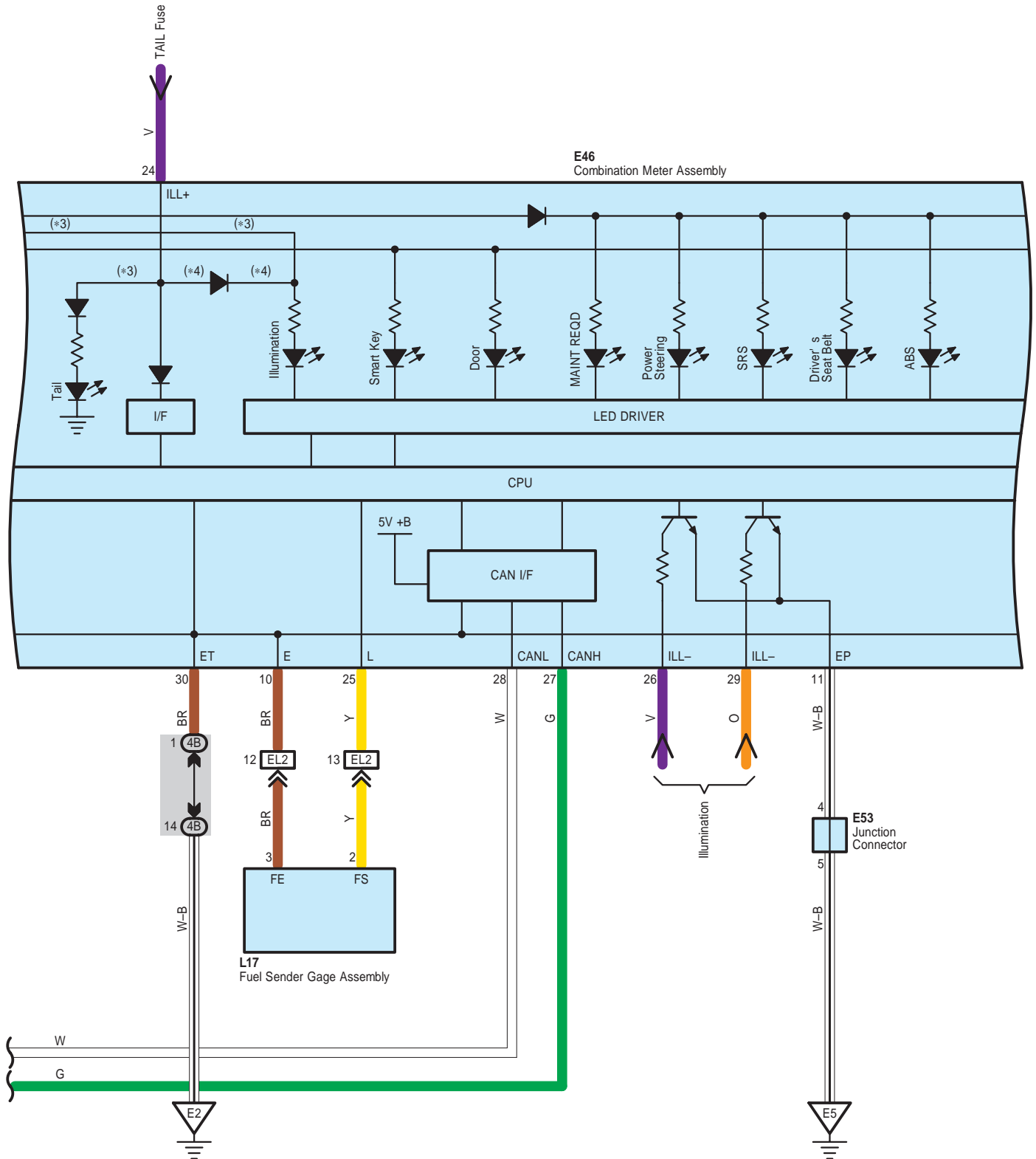

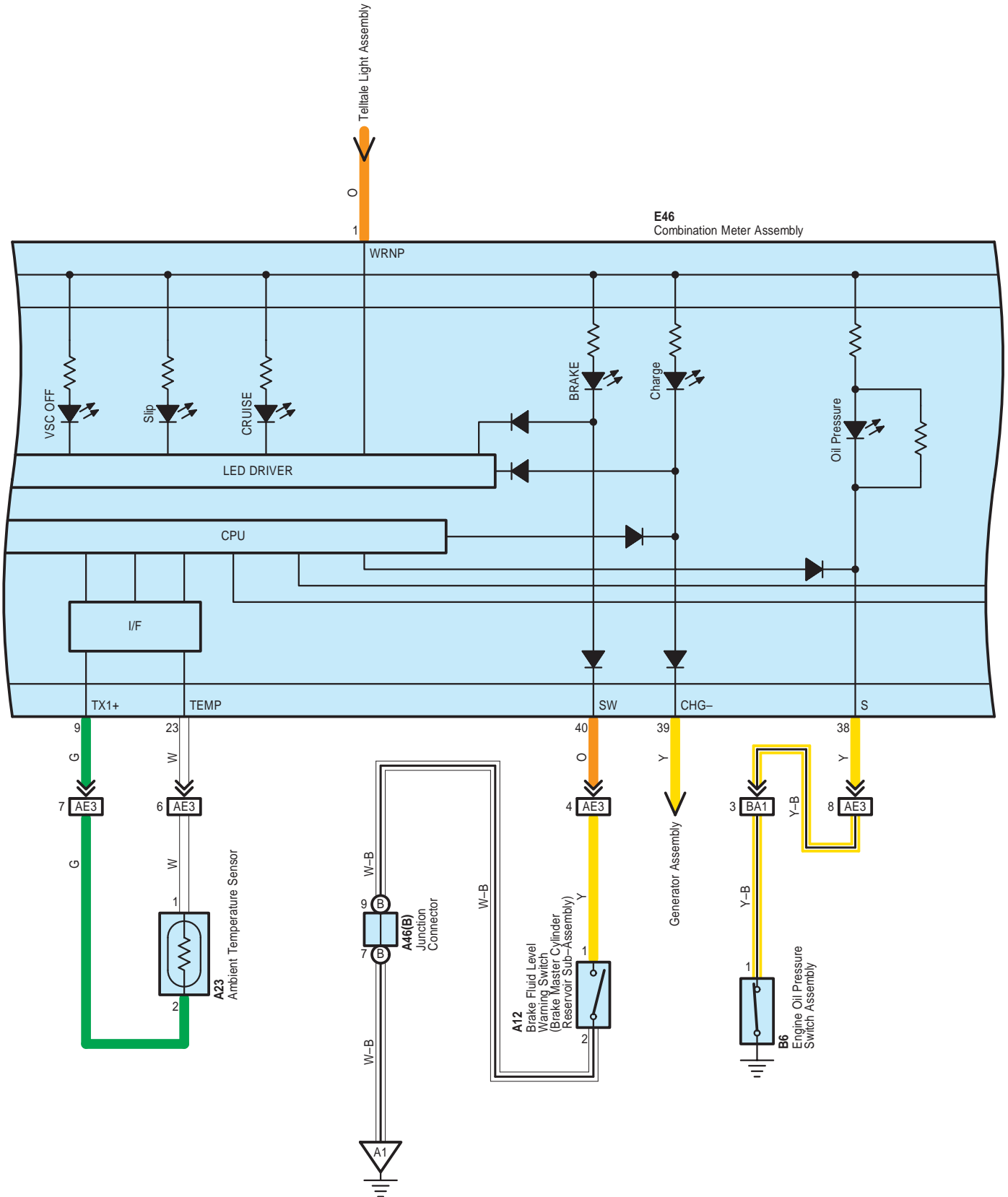

E46  
Combination Meter Assembly

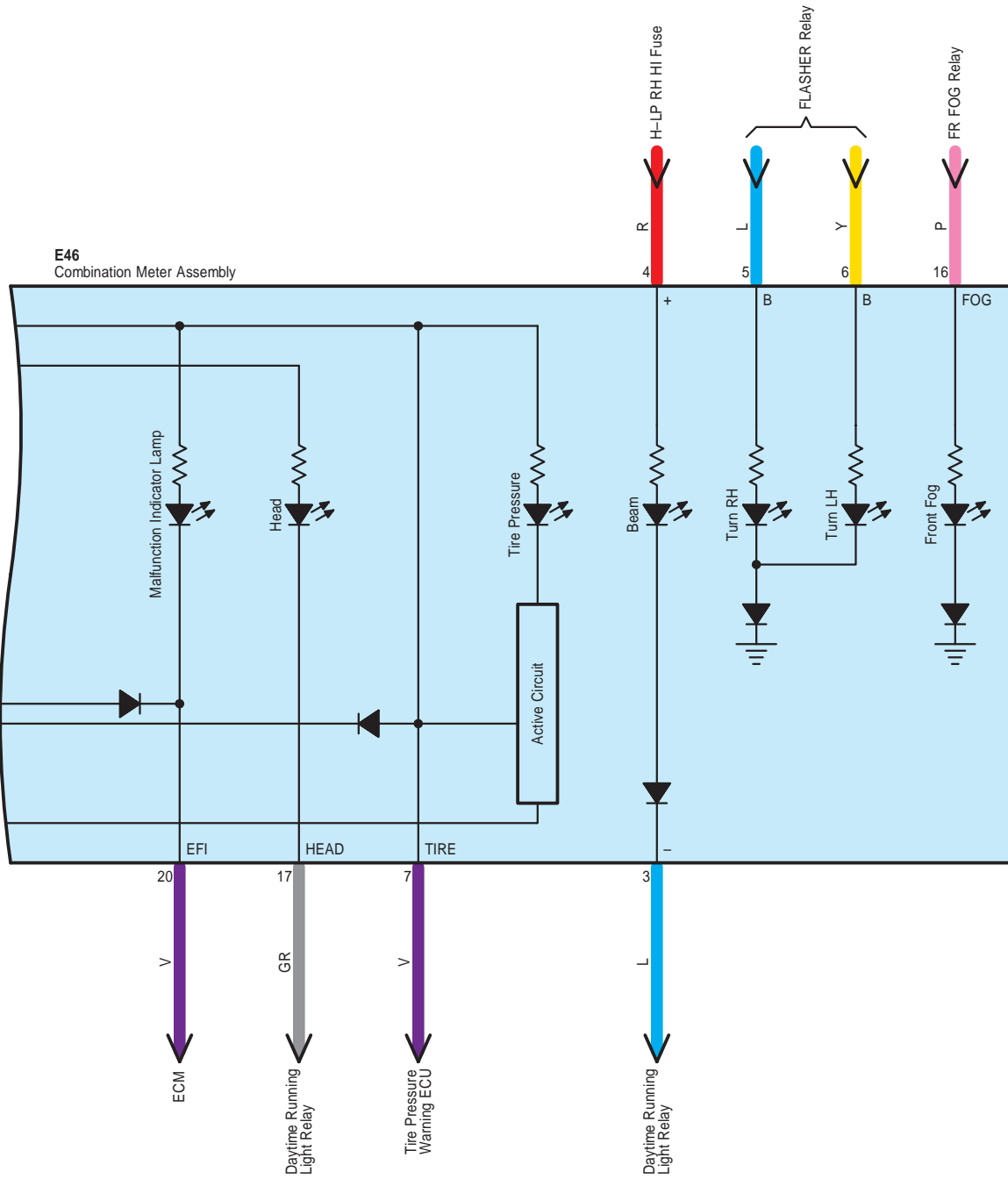

Combination Meter <TMC Made>

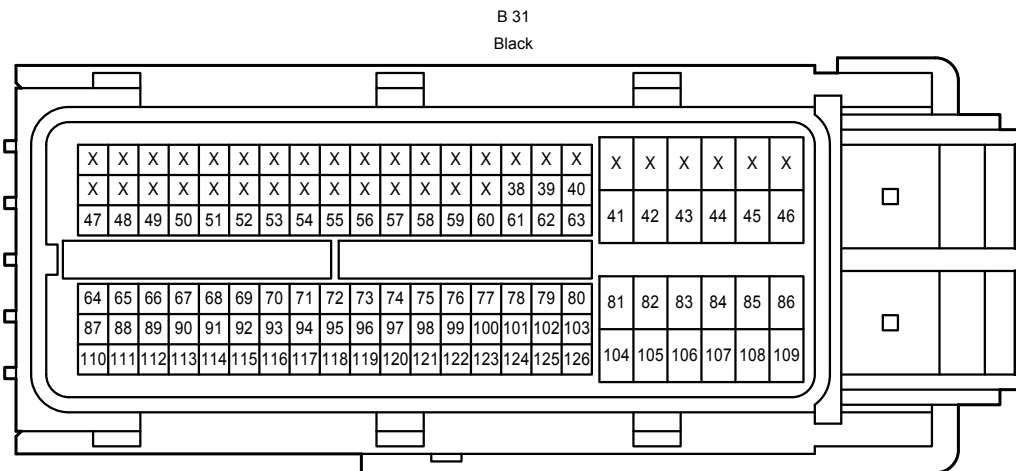
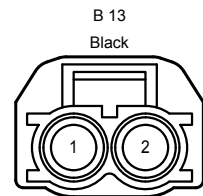
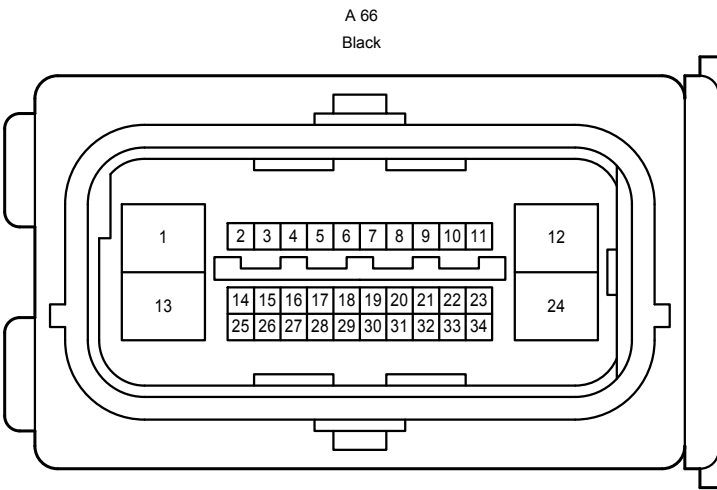
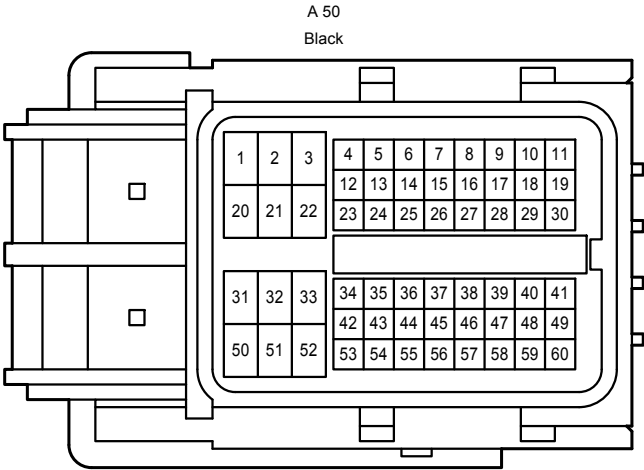
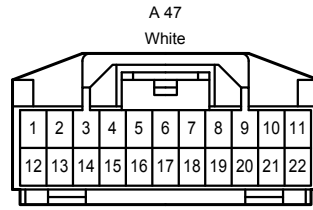
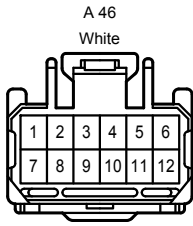

Combination Meter <TMC Made>

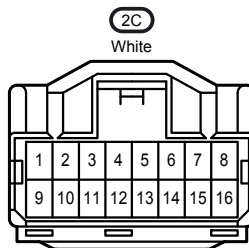
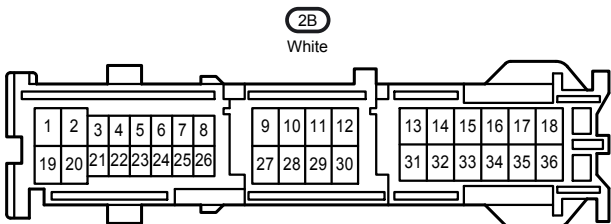
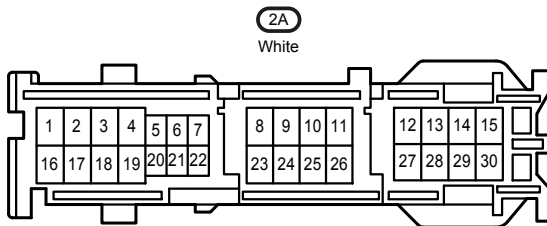
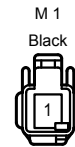
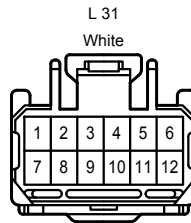
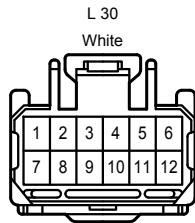
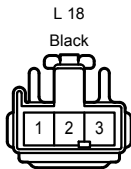
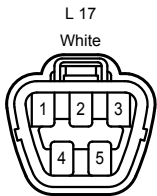
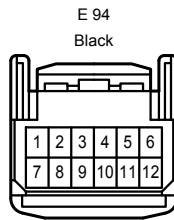
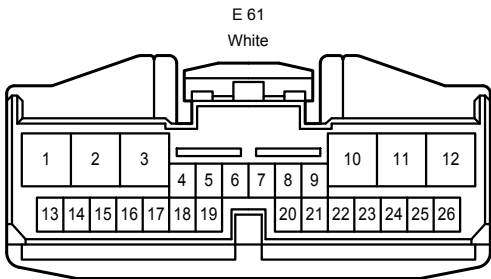
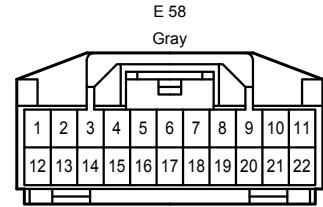
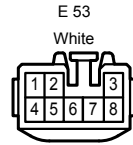
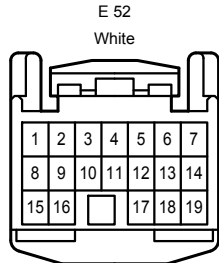
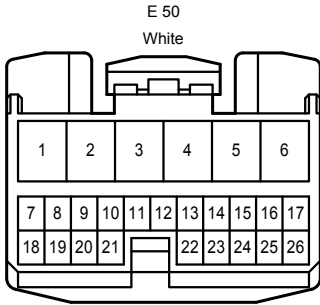
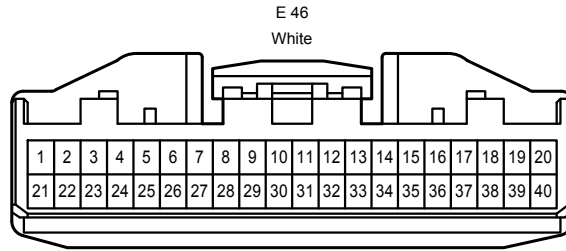
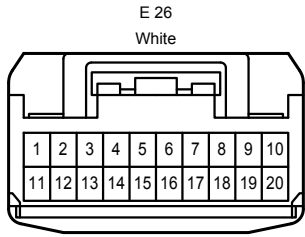

Combination Meter <TMC Made>

2E  
White

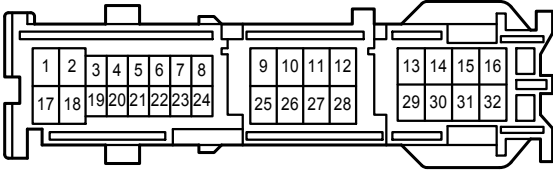

2H  
White

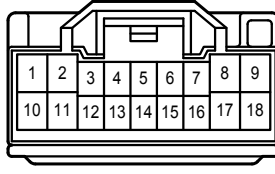

2M  
White

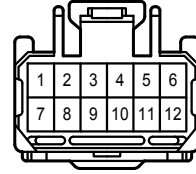

3A  
White

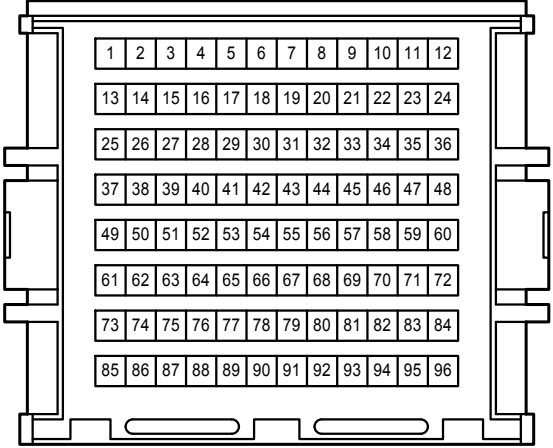

3B  
White

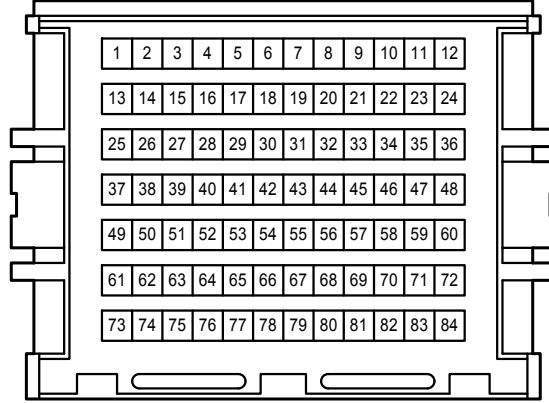

4A  
White

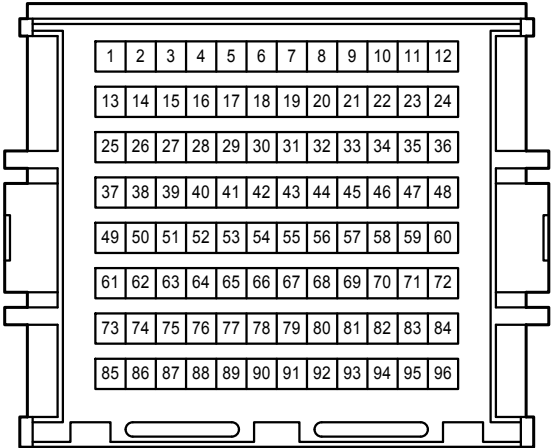

4B  
White

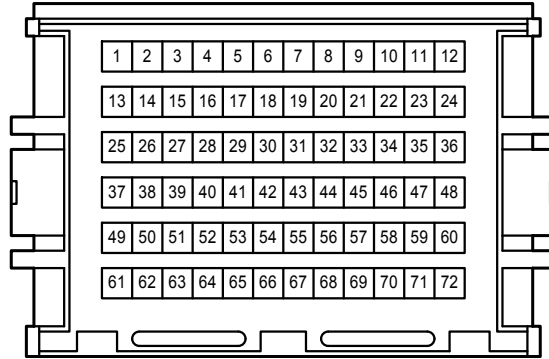

4C  
White

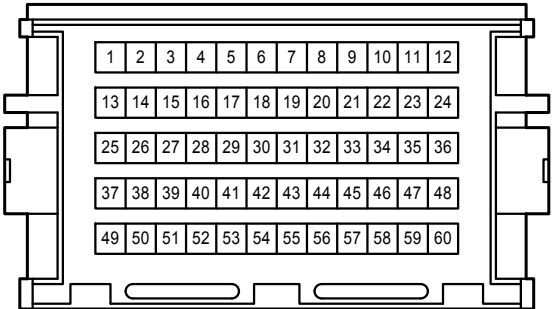



AE3  
White

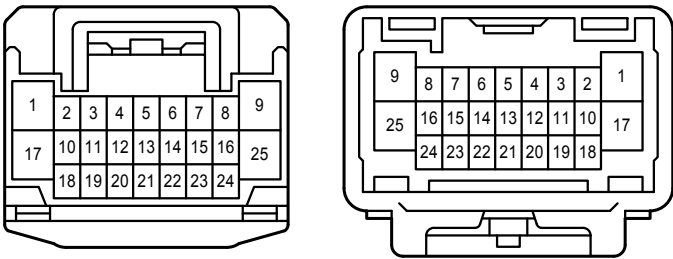

AE6  
Gray

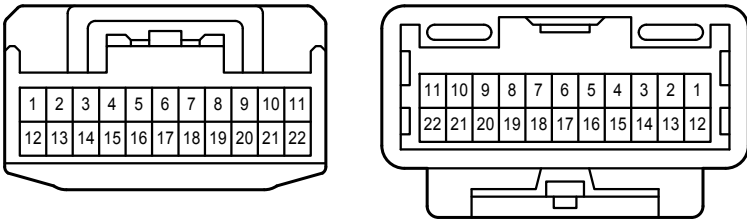

AE10  
Gray

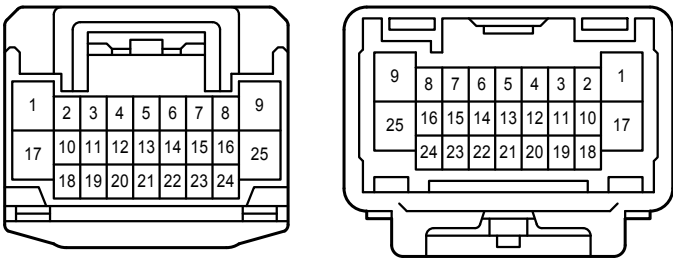

BA1  
White

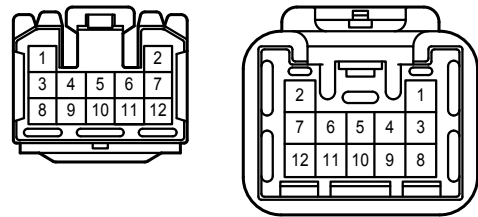

EL1  
White

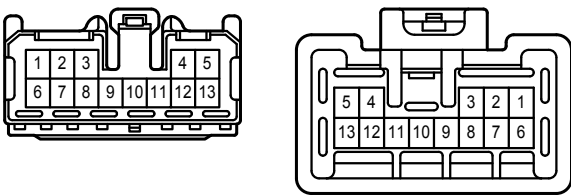

EL2  
White

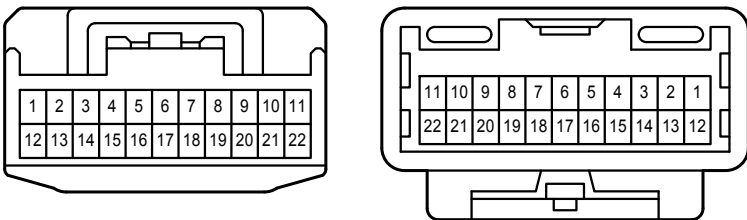

EM1  
Gray

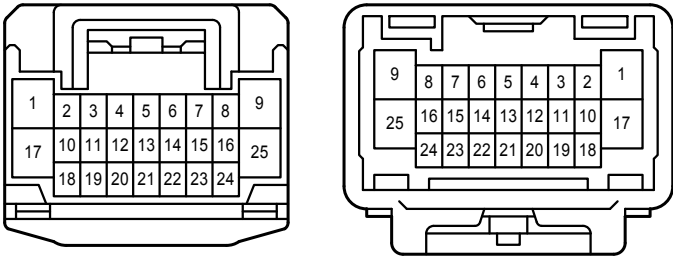

Cooling Fan <2AZ-FE , Except TMC Made>

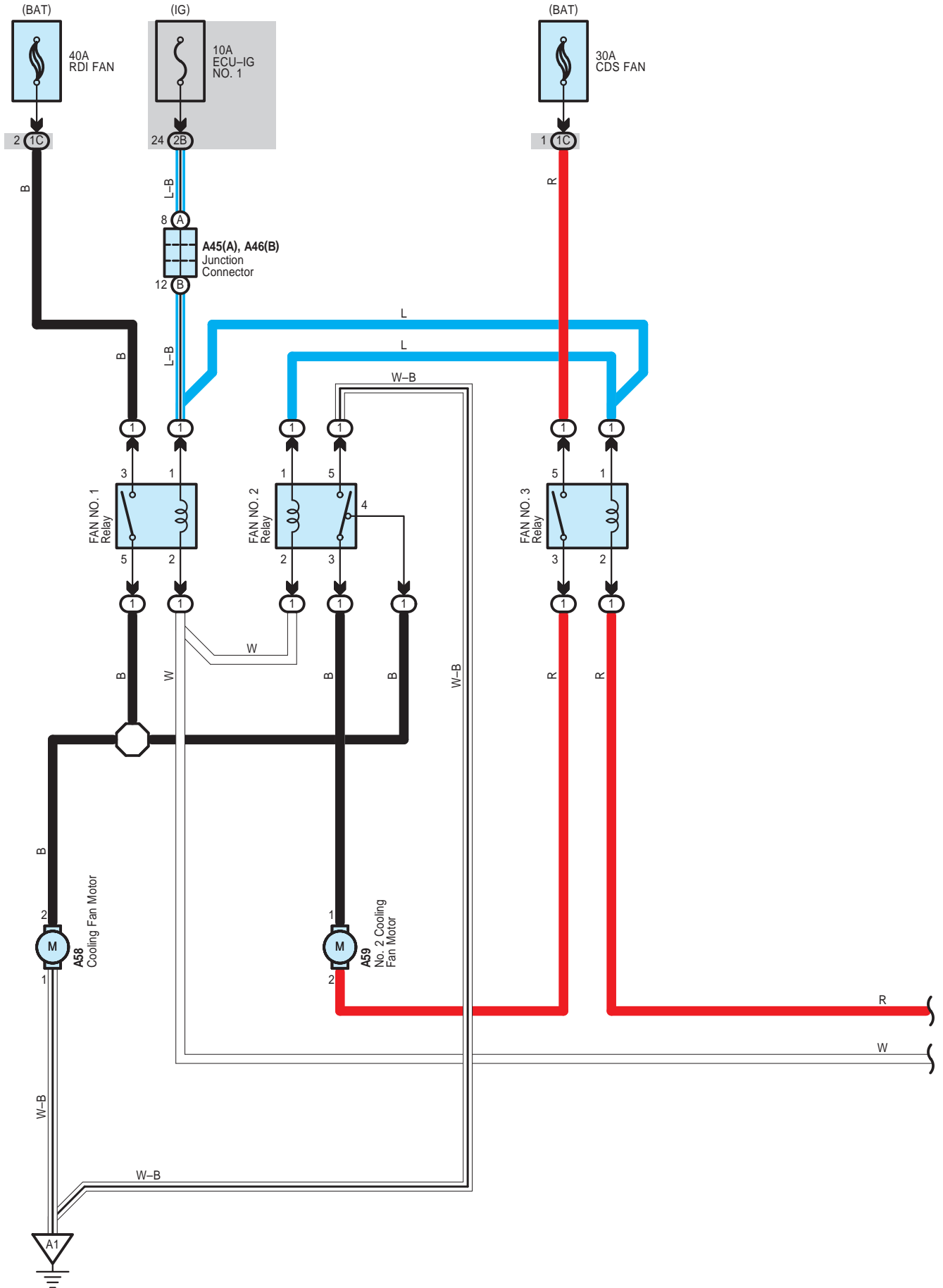

\* 1 : Automatic A/C  
 \* 2 : Manual A/C

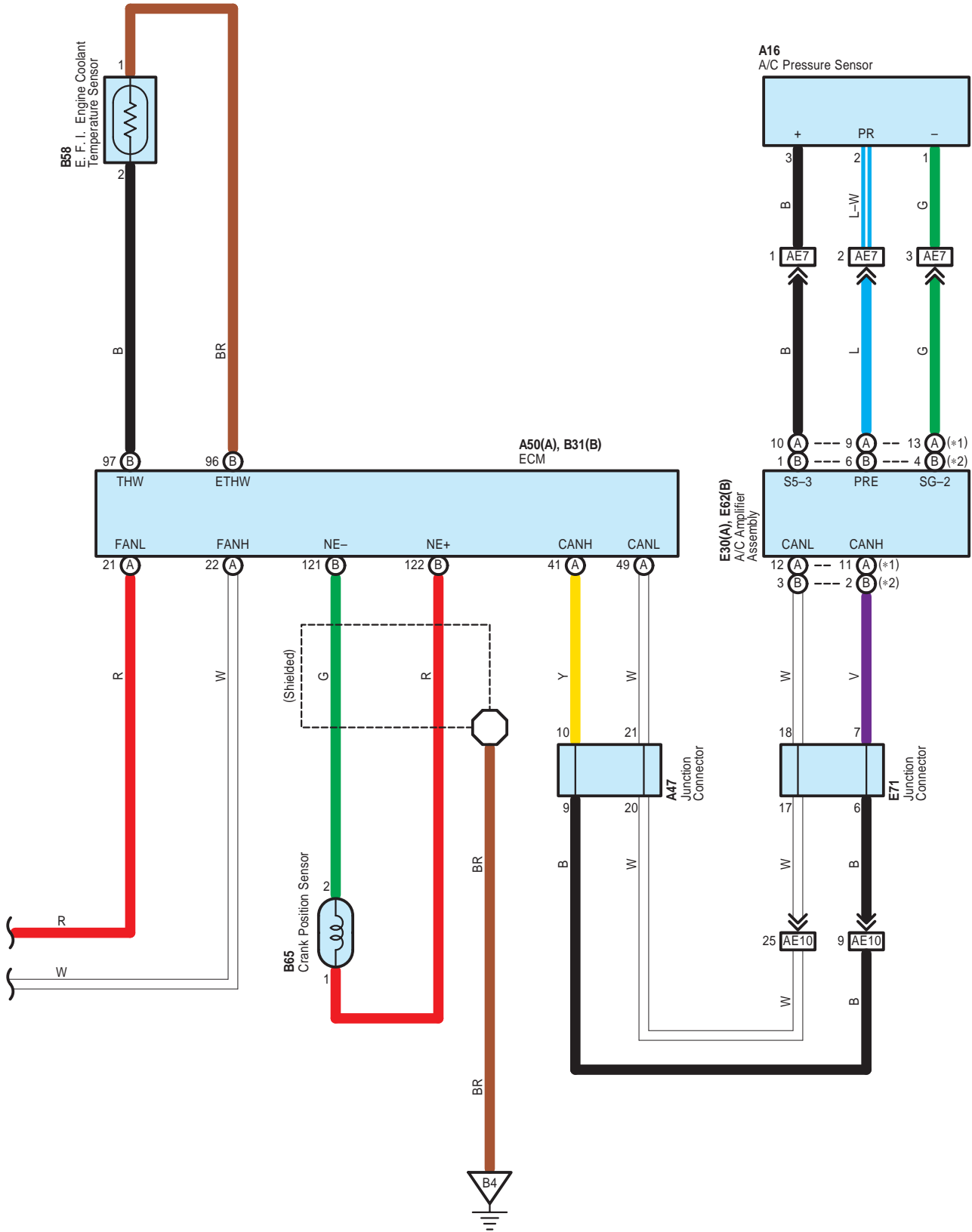

Cooling Fan <2AZ-FE , Except TMC Made>

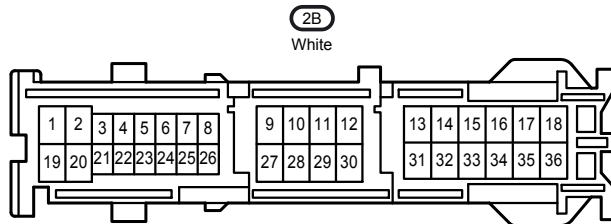
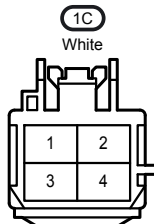
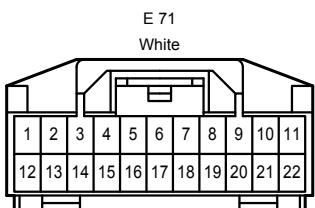
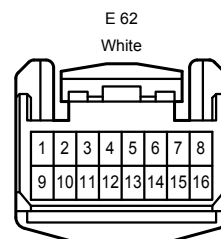
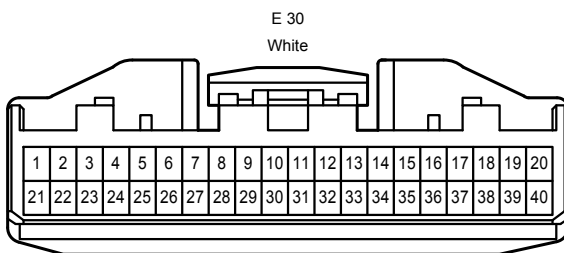
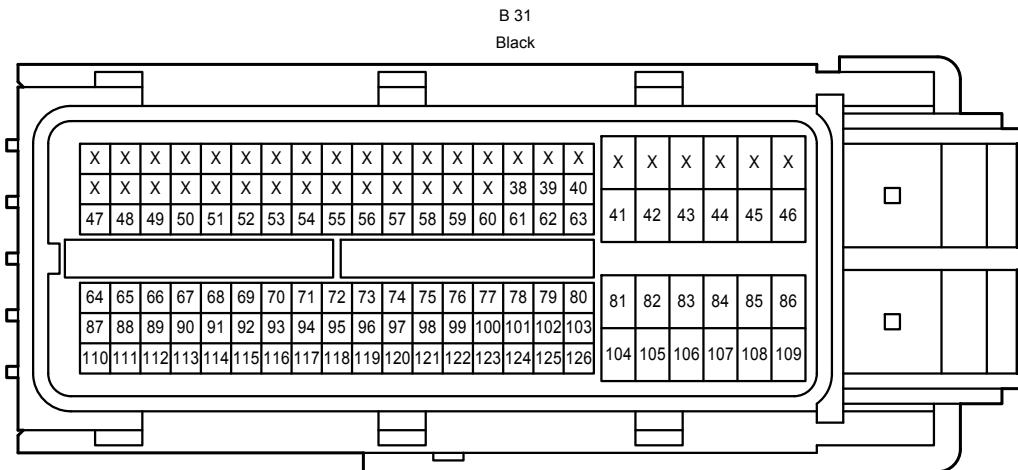
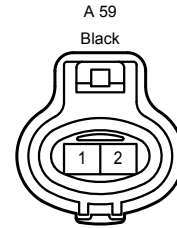
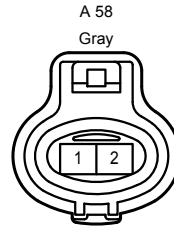
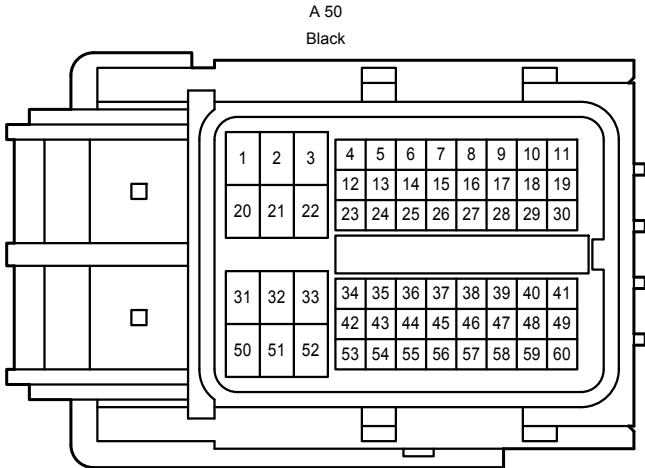
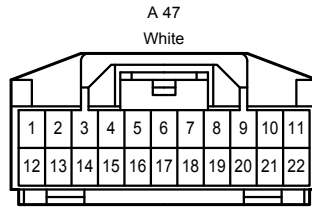
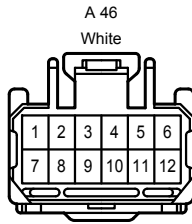
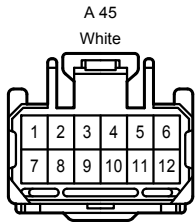
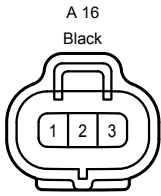

Cooling Fan <2AZ-FE , Except TMC Made>

AE7  
Blue

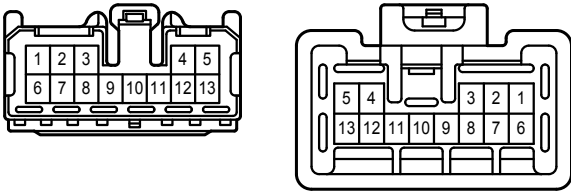

AE10  
Gray

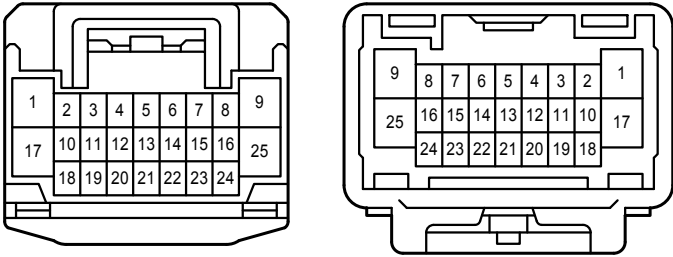

Cooling Fan <2ZR-FE , Except TMC Made>

\* 1 : Automatic A/C  
 \* 2 : Manual A/C

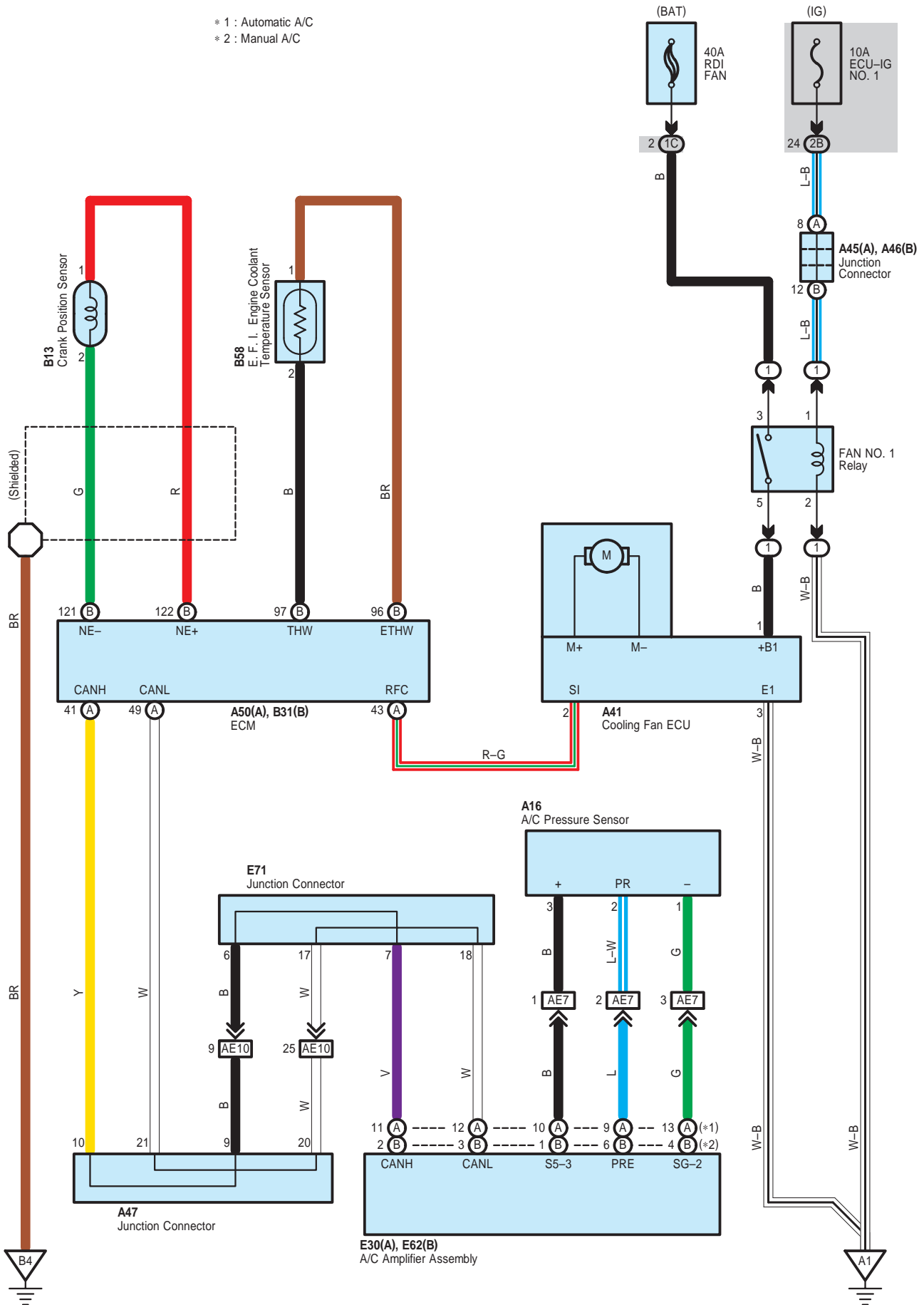

**Cooling Fan <2ZR-FE , Except TMC Made>**

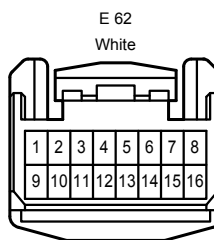
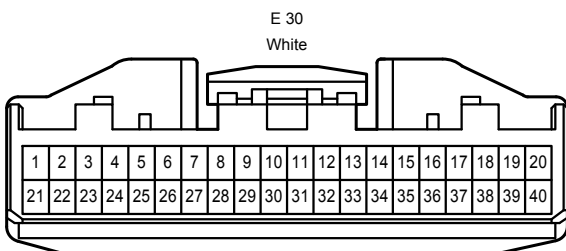
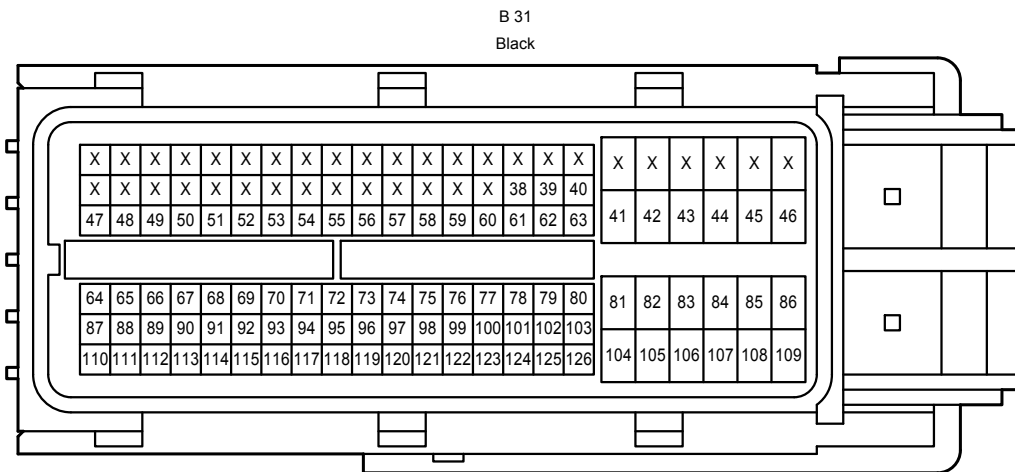
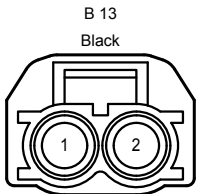
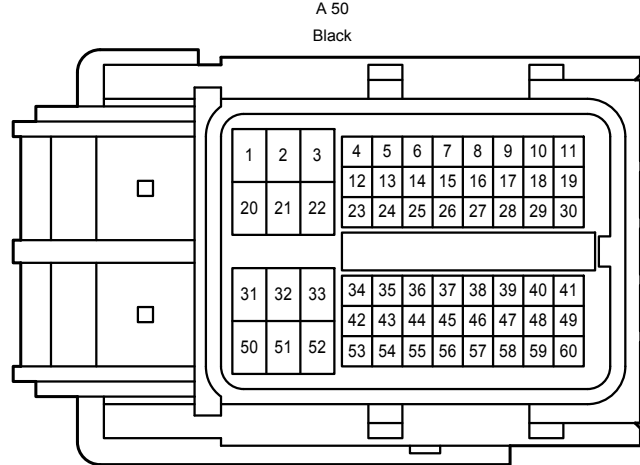
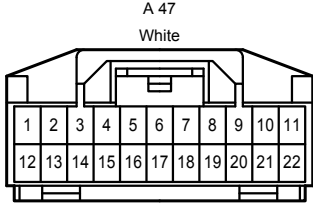
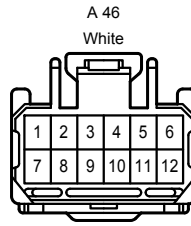
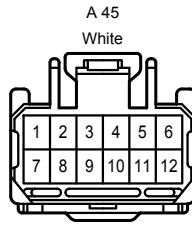
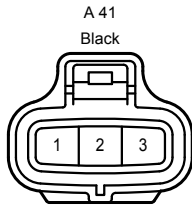
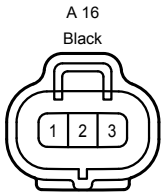



Cooling Fan <2ZR-FE , Except TMC Made>

E 71  
White

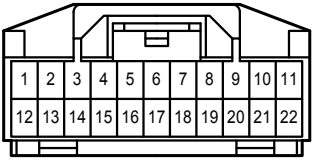

1C  
White

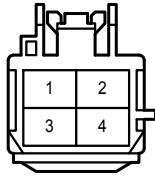

2B  
White

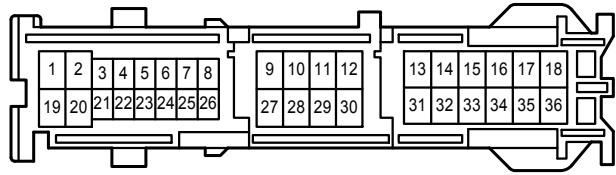

AE7  
Blue

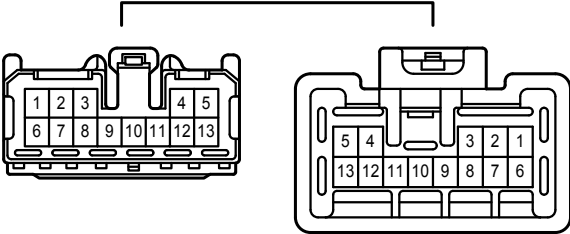

AE10  
Gray

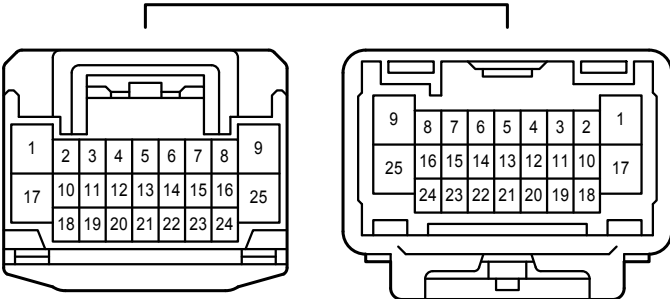

Cooling Fan <TMC Made>

\* 1 : Automatic A/C  
 \* 2 : Manual A/C

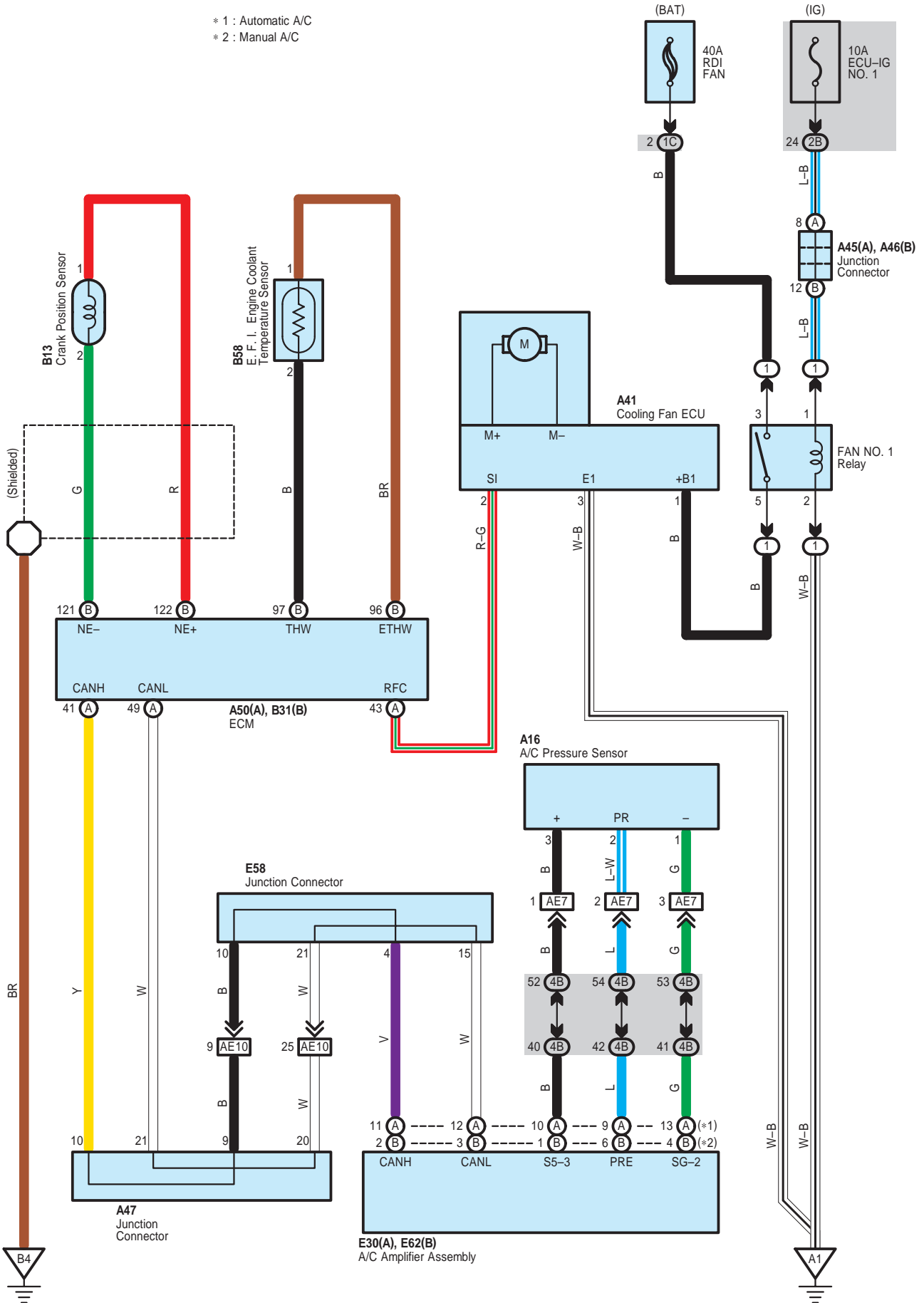

**Cooling Fan <TMC Made>**

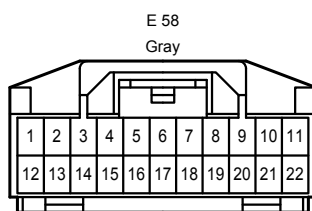
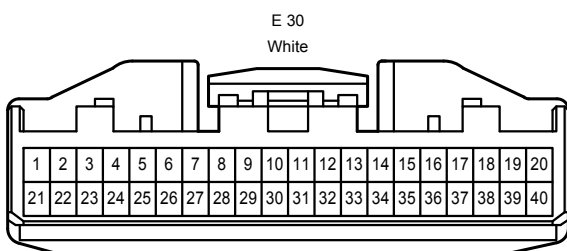
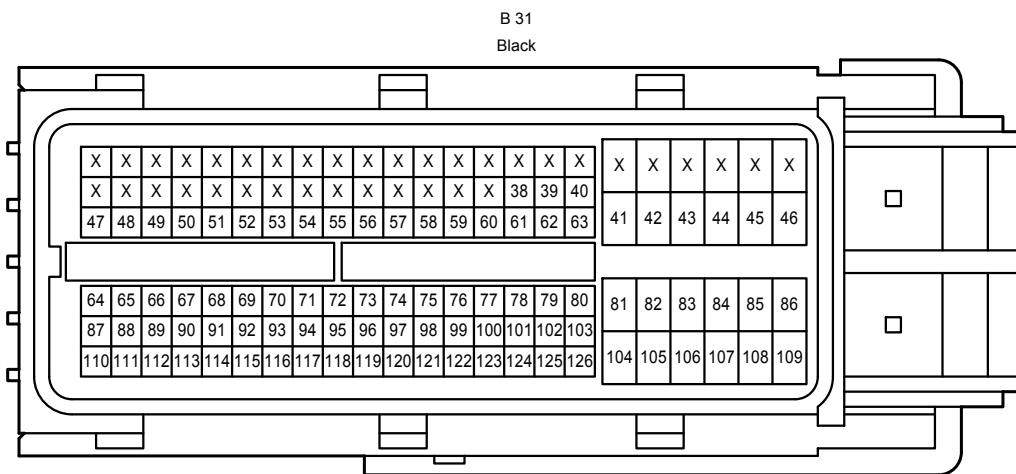
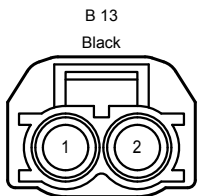
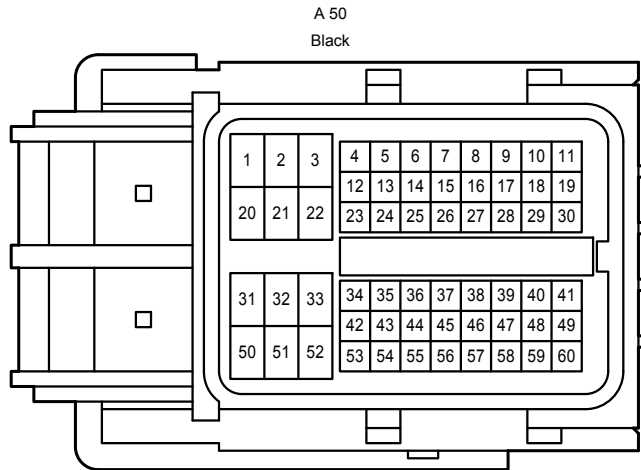
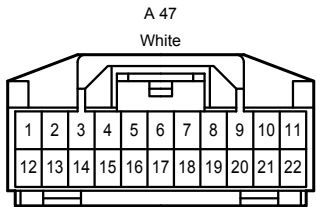
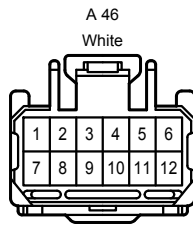
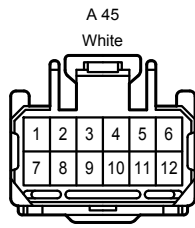
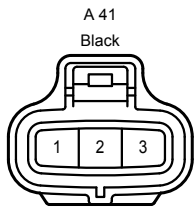
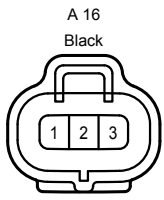

Cooling Fan <TMC Made>

E 62  
White

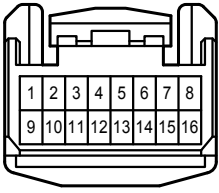

1C  
White

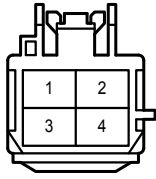

2B  
White

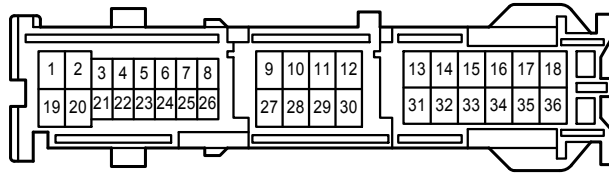

4B  
White

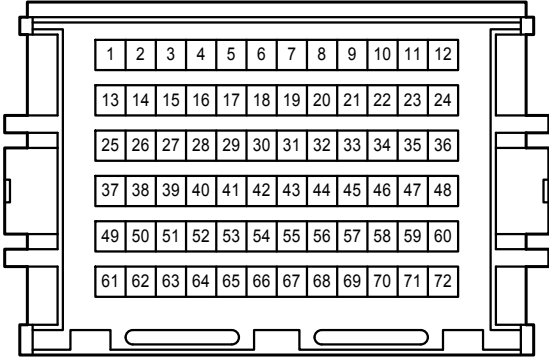

AE7  
Blue

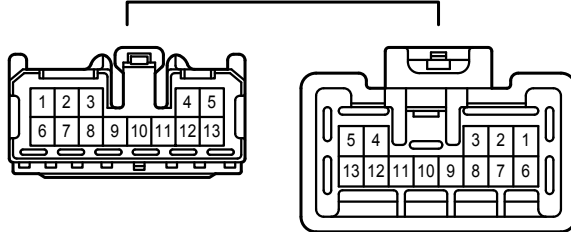

AE10  
Gray

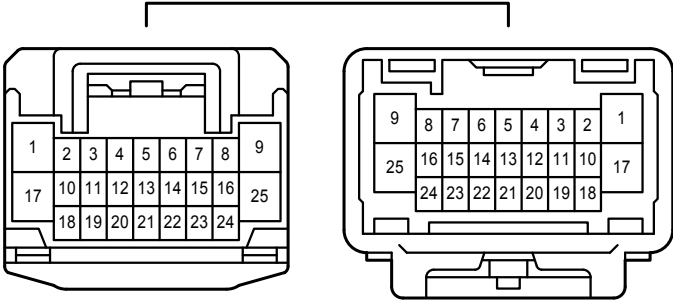

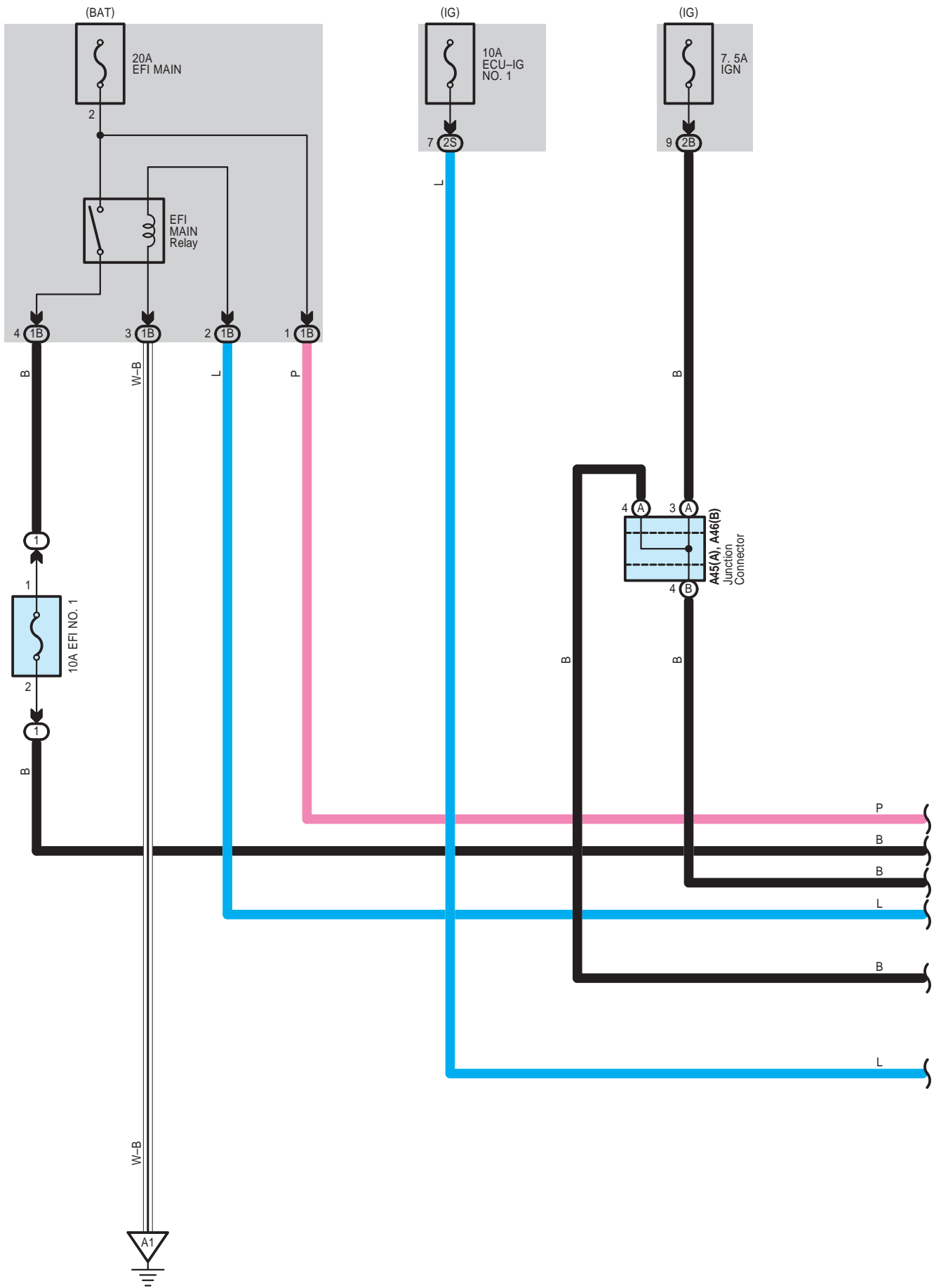

Cruise Control <2AZ-FE , Except TMC Made>

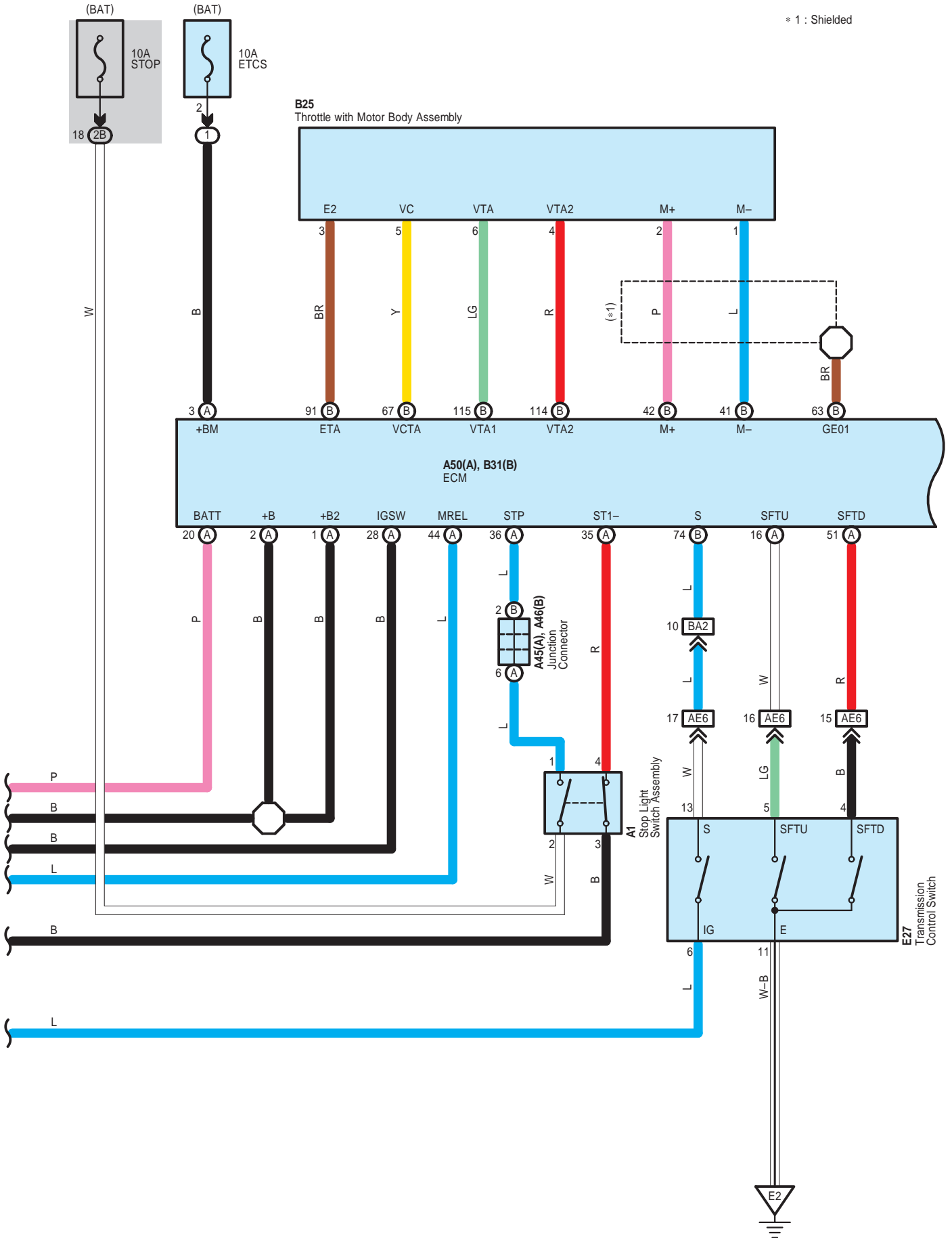

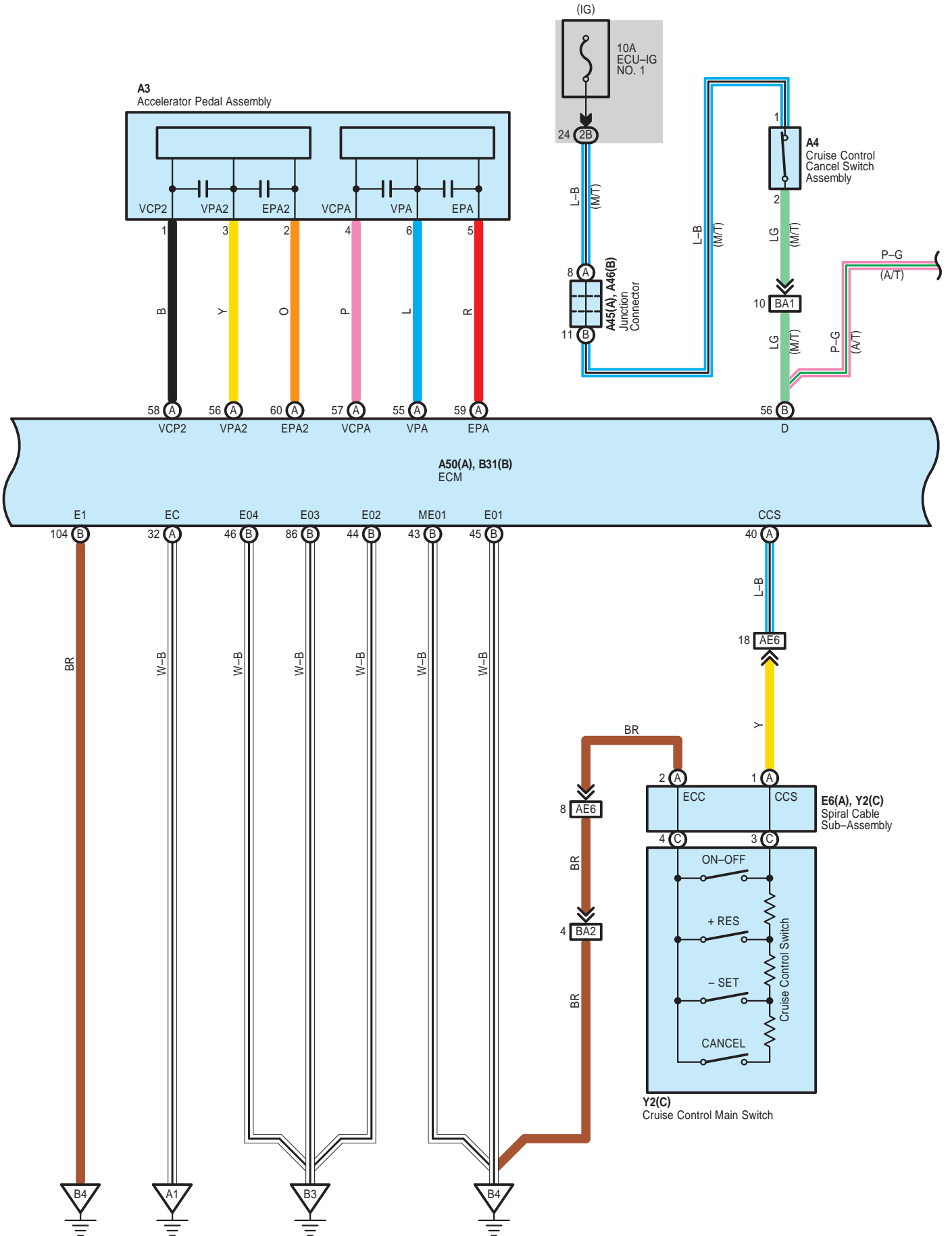

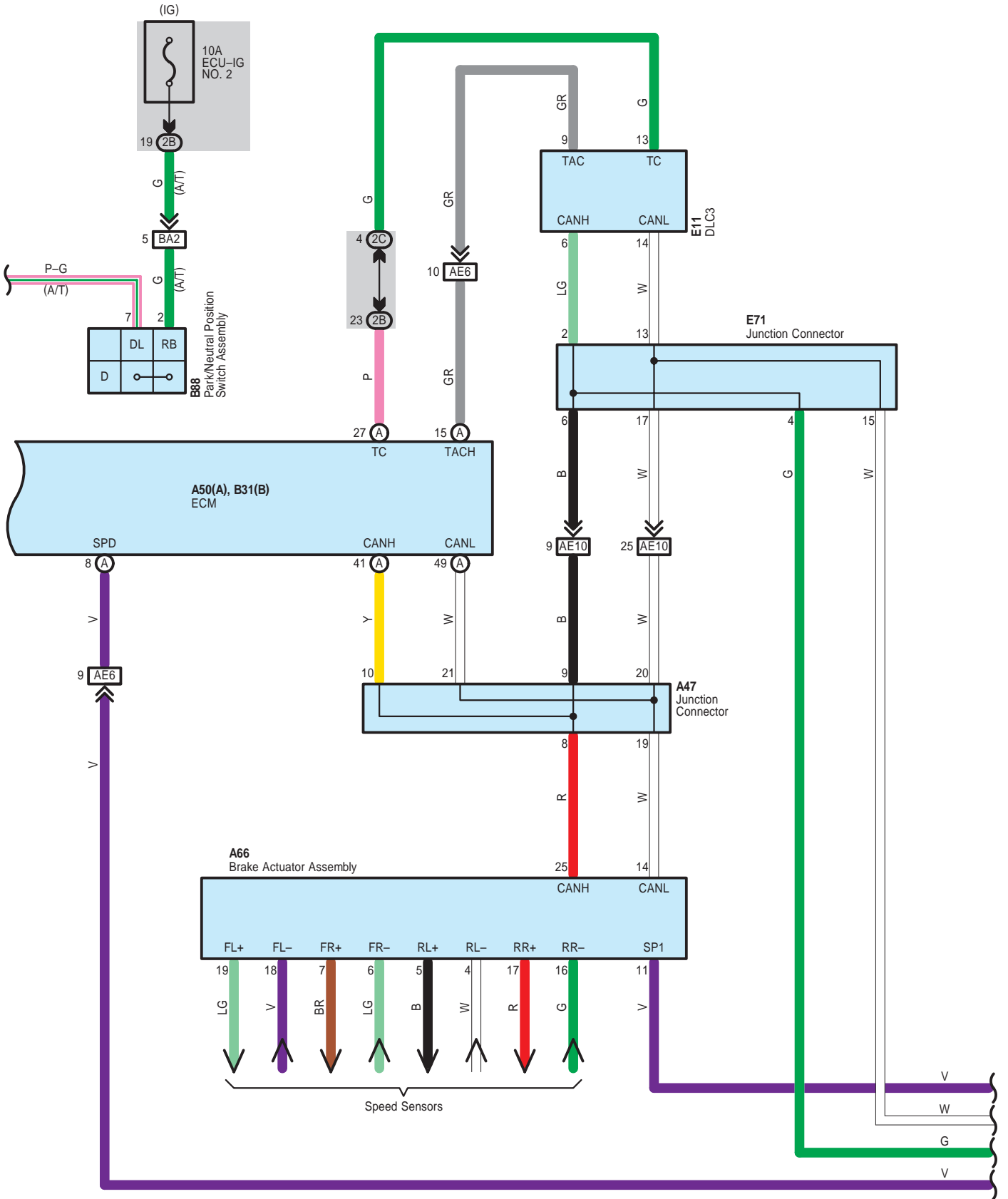



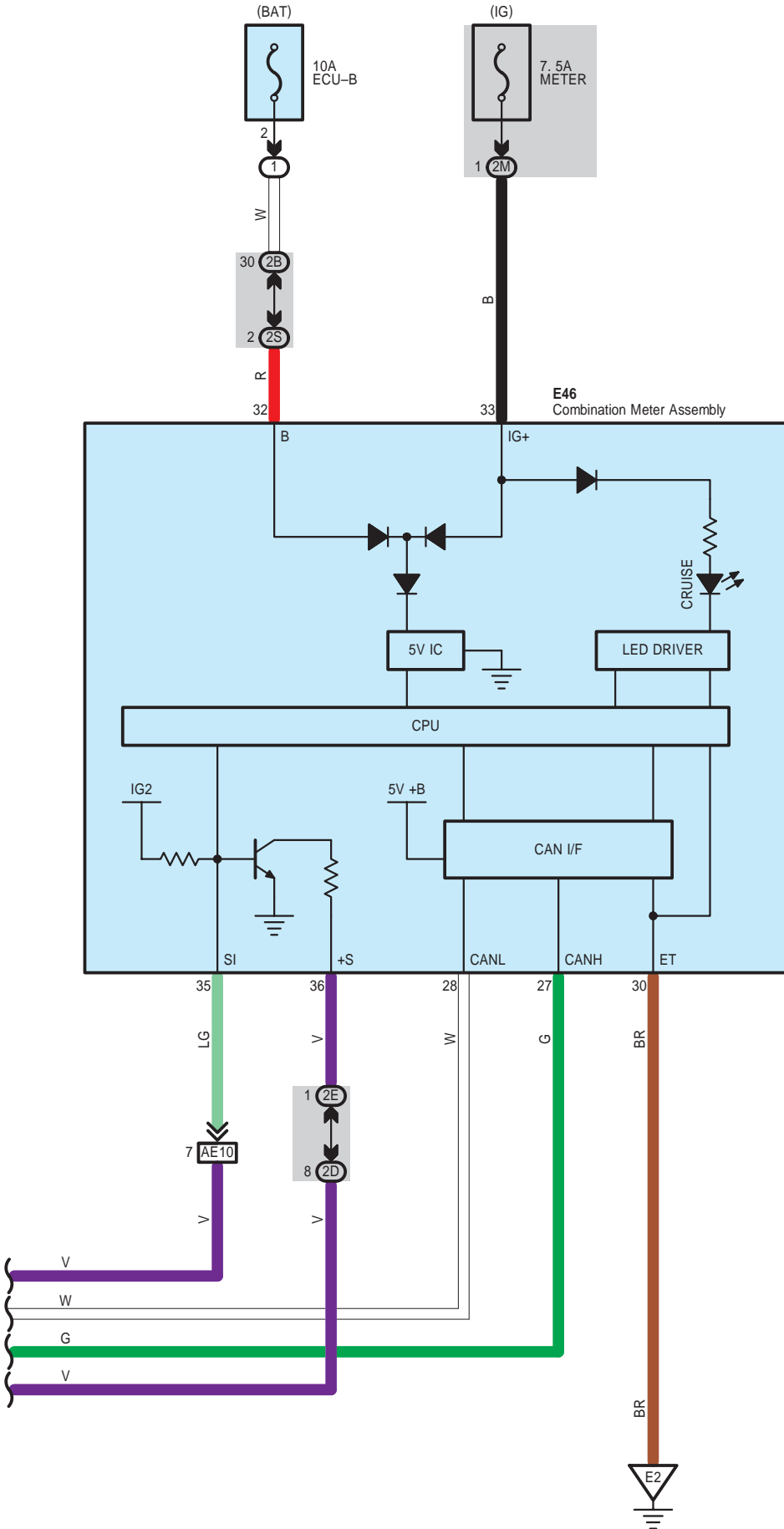

Cruise Control <2AZ-FE , Except TMC Made>

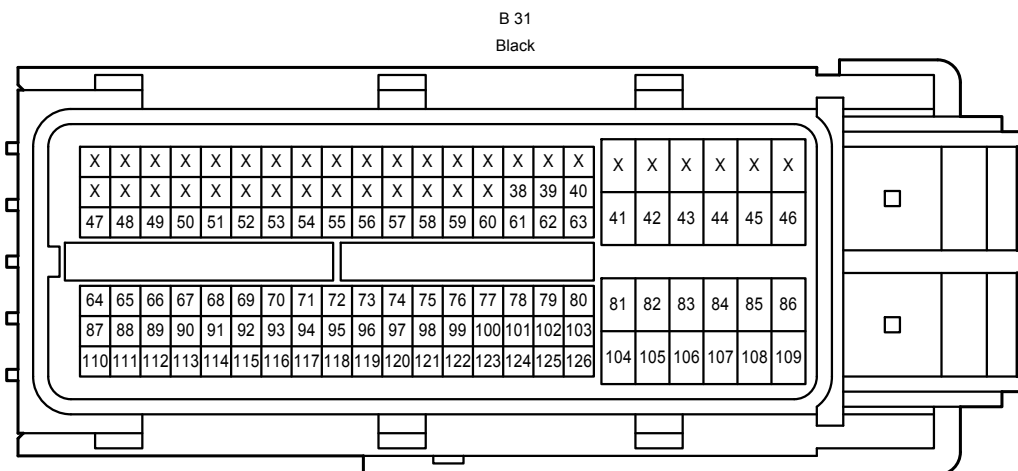
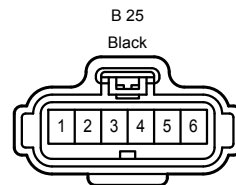
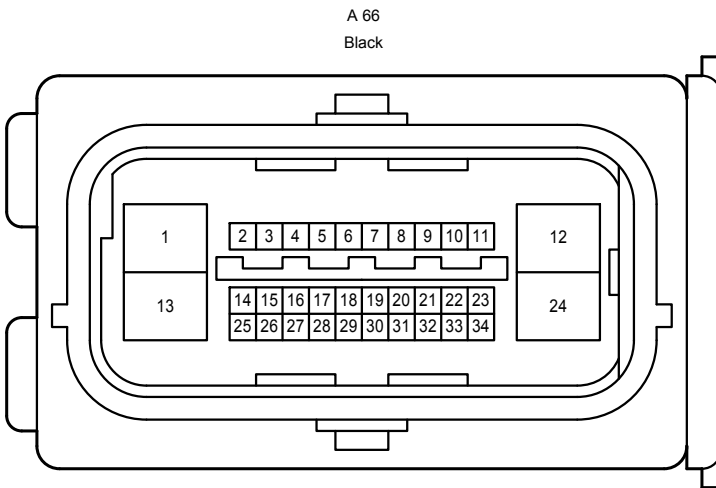
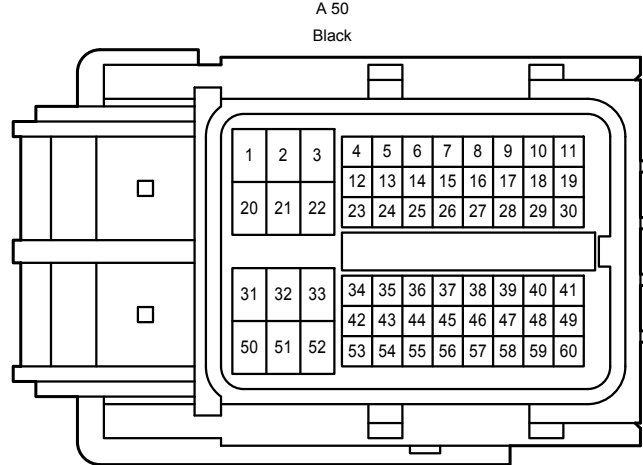
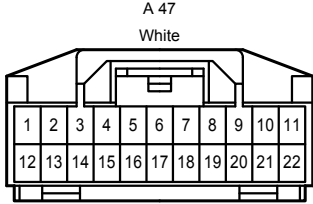
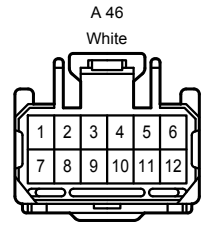
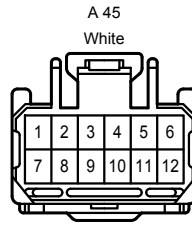
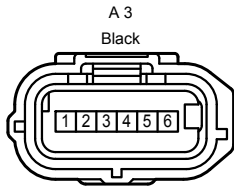
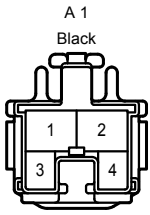

Cruise Control <2AZ-FE , Except TMC Made>

B 88  
Gray

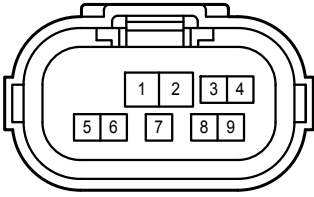

E 6  
Black

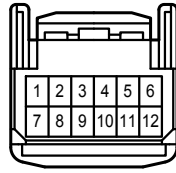

E 11  
White

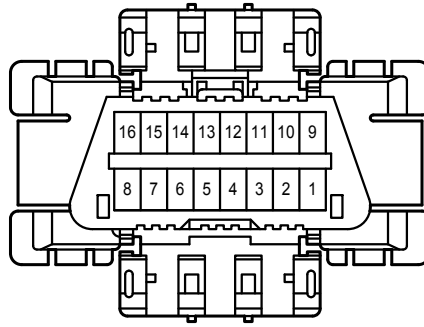

E 27  
White

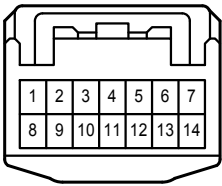

E 46  
White

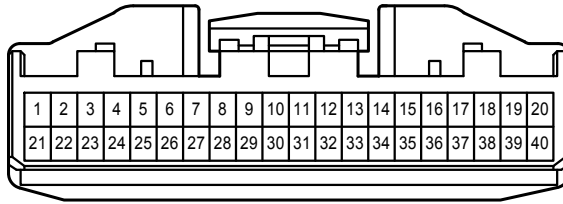

E 71  
White

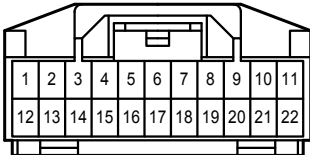

Y 2  
White

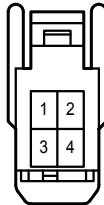

1B  
White

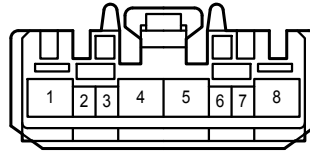

2B  
White

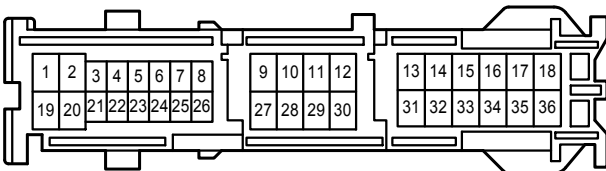

2C  
White

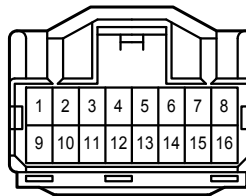

2D  
White

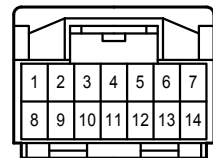

2E  
White

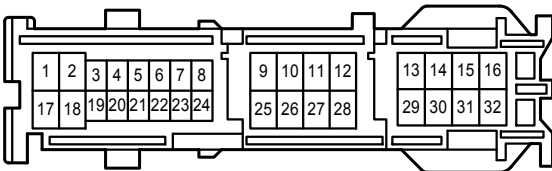

2M  
White

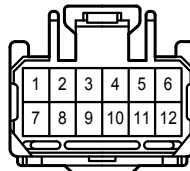

2S  
White

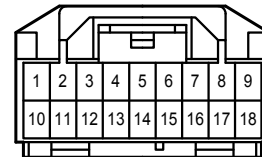

AE6  
Gray

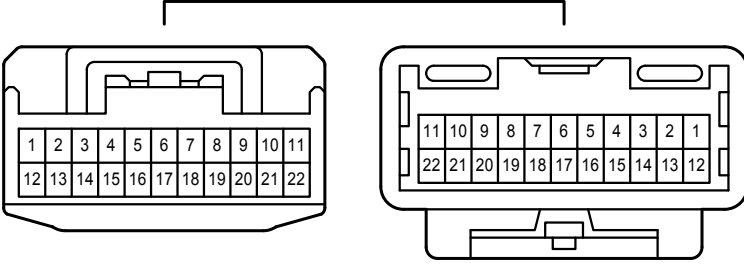

AE10  
Gray

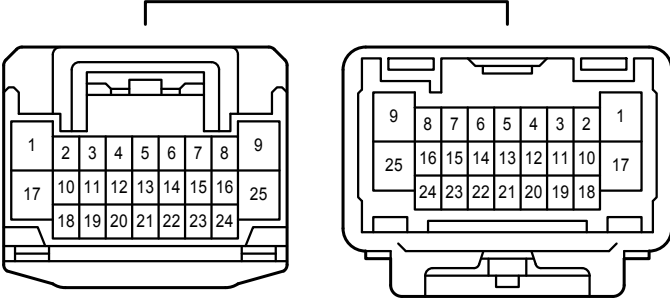

BA1  
White

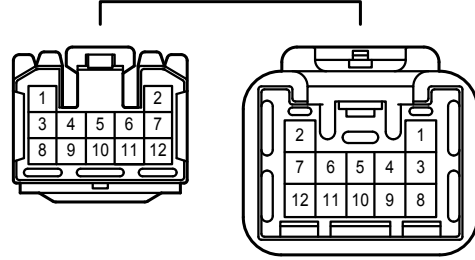

BA2  
White

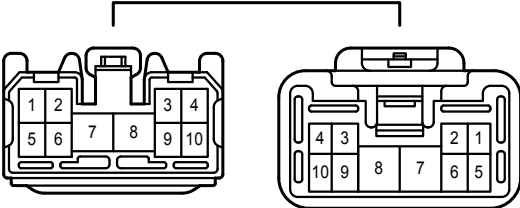

Cruise Control <2ZR-FE , Except TMC Made>

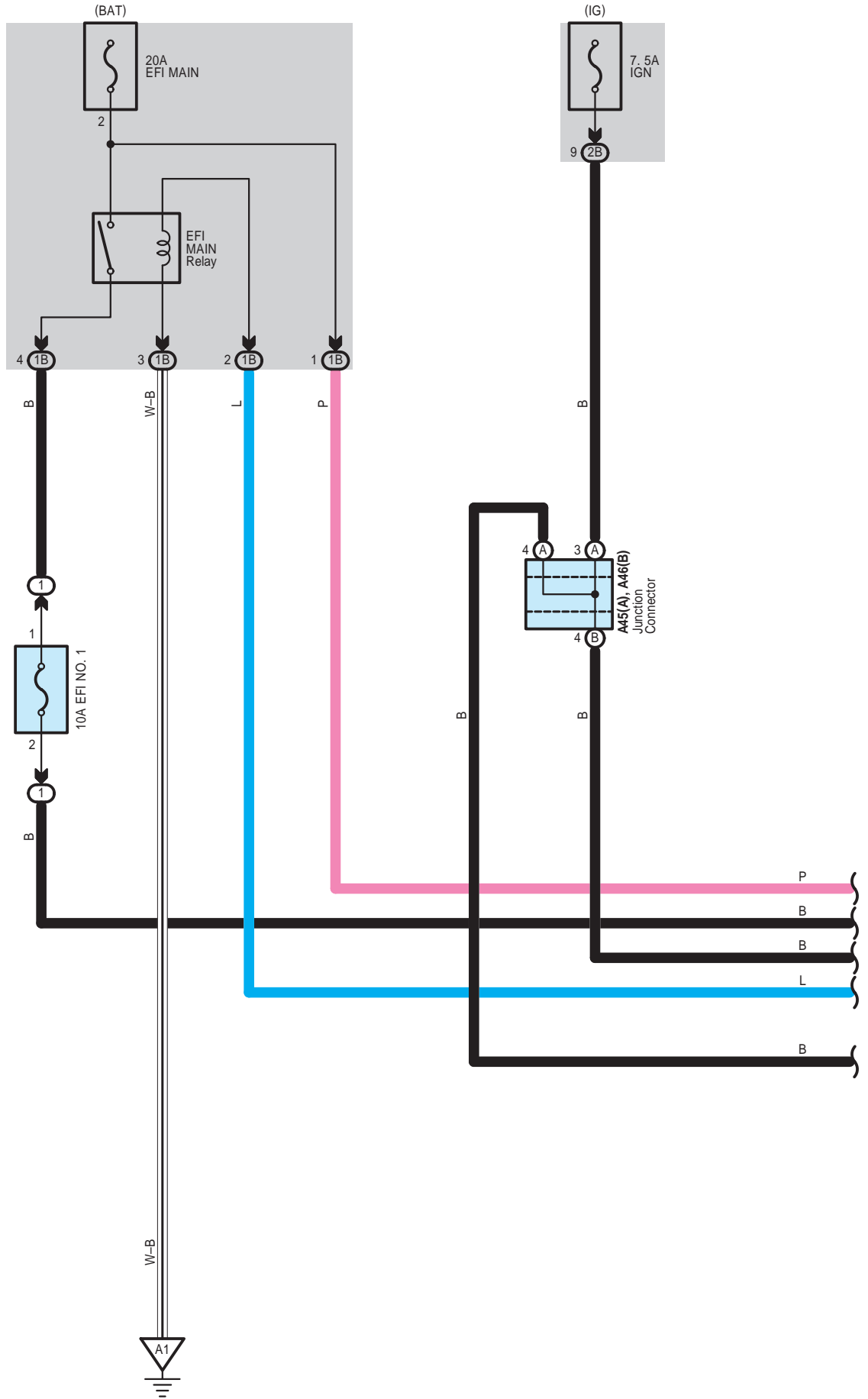

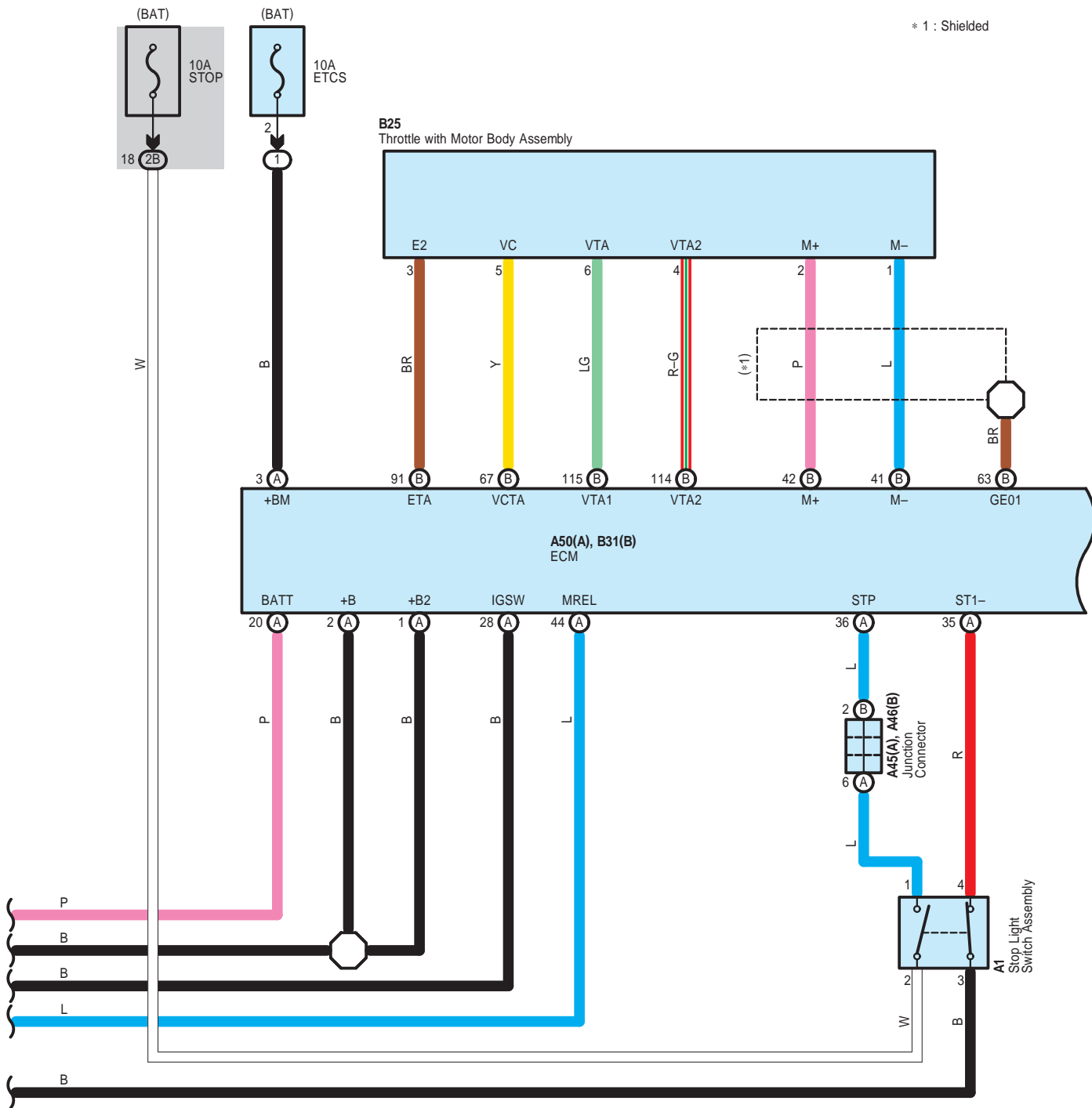

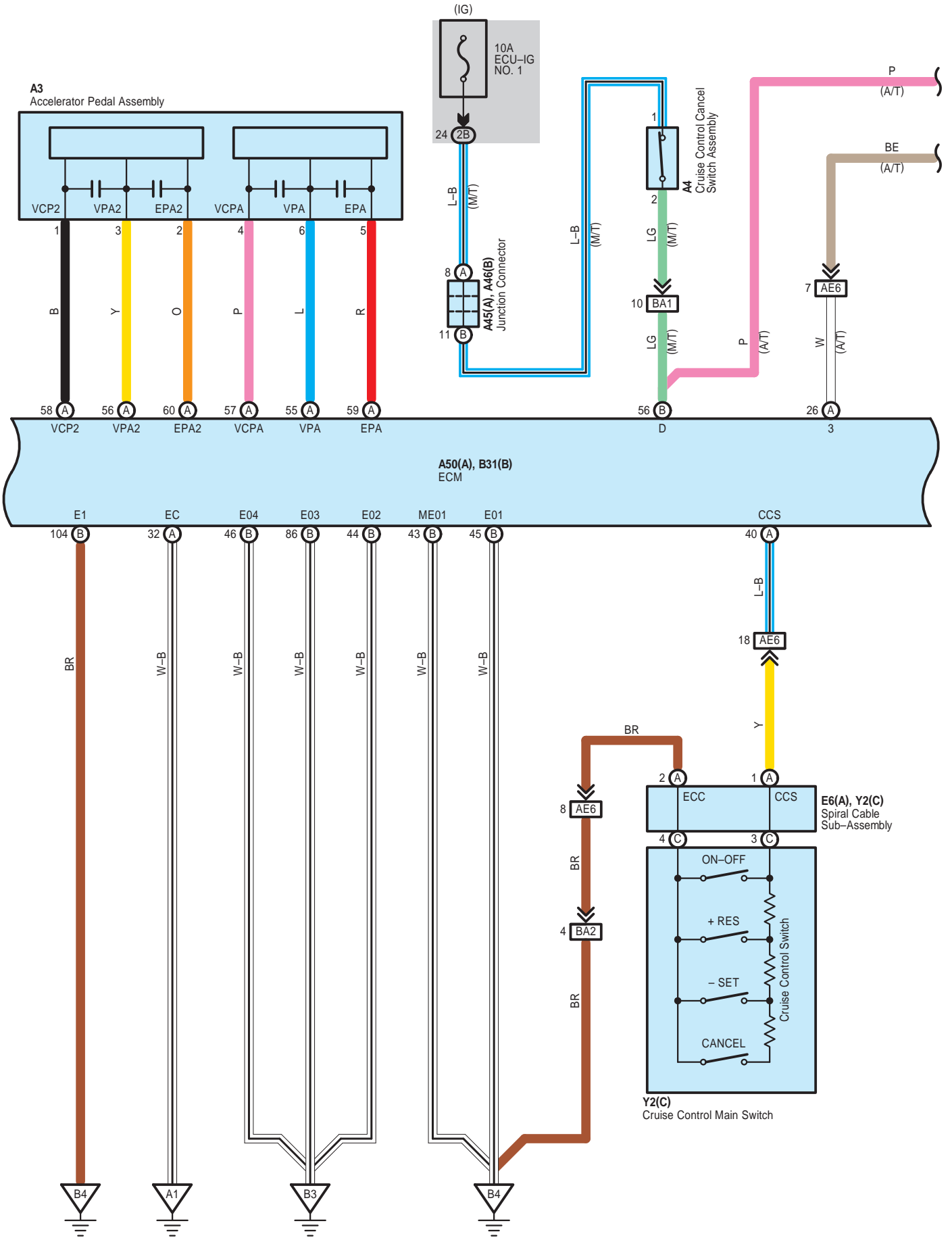

Cruise Control <2ZR-FE , Except TMC Made>

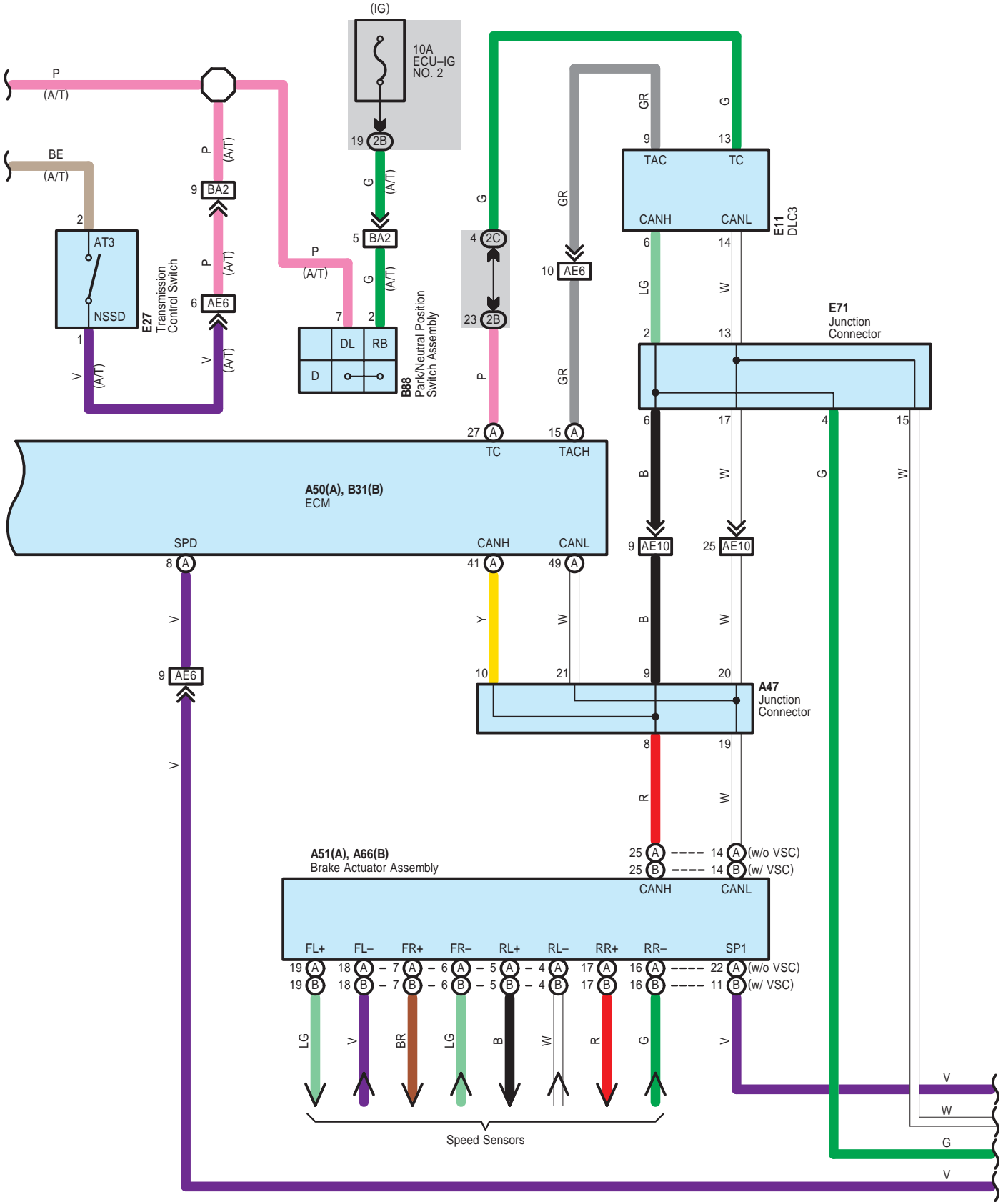



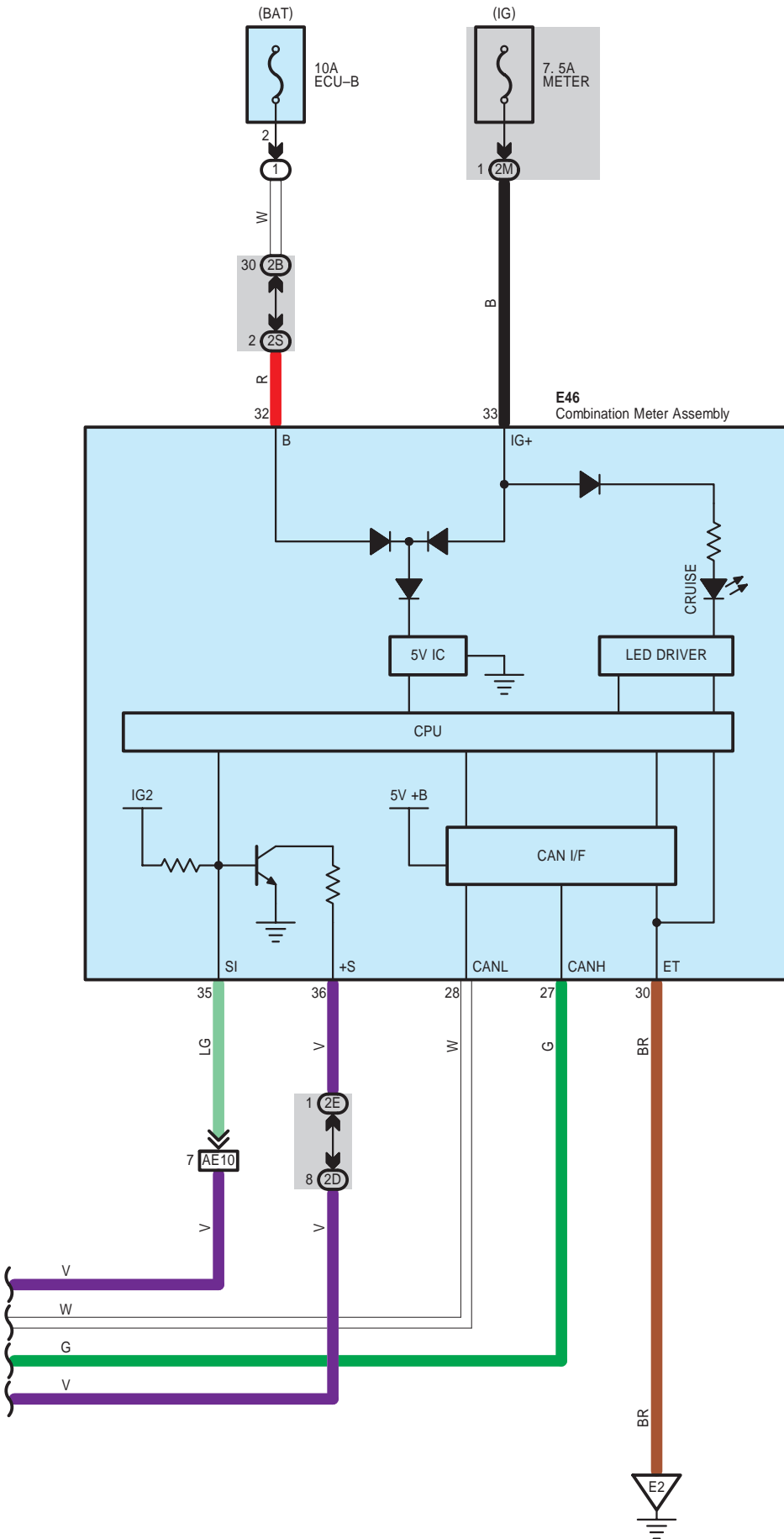

Cruise Control <2ZR-FE , Except TMC Made>

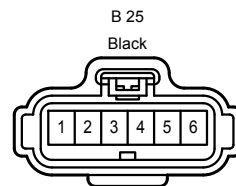
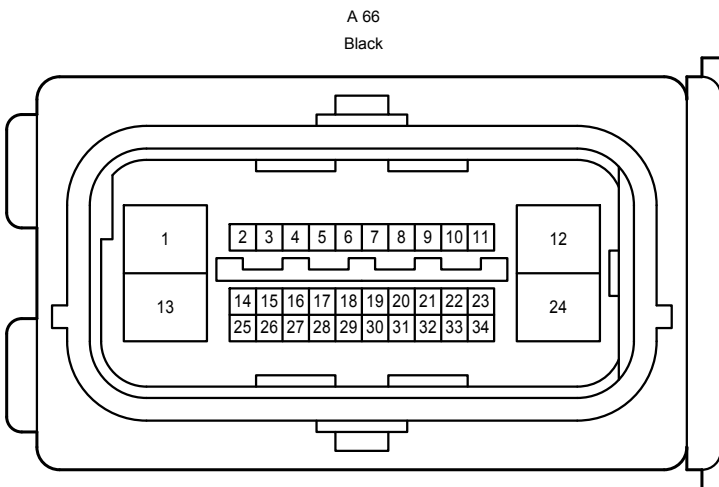
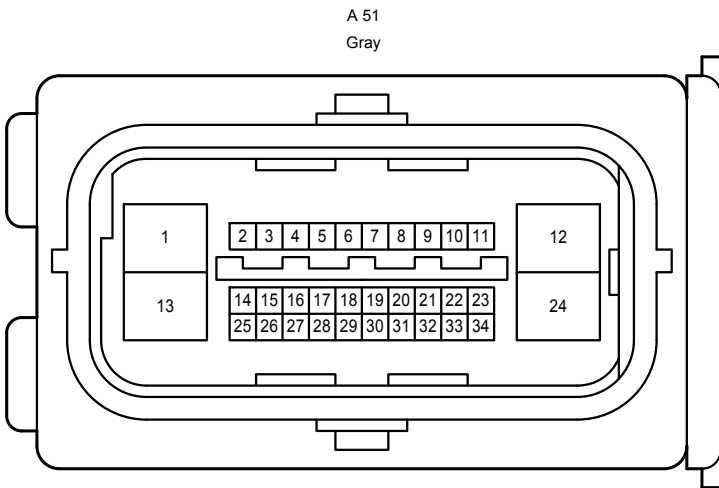
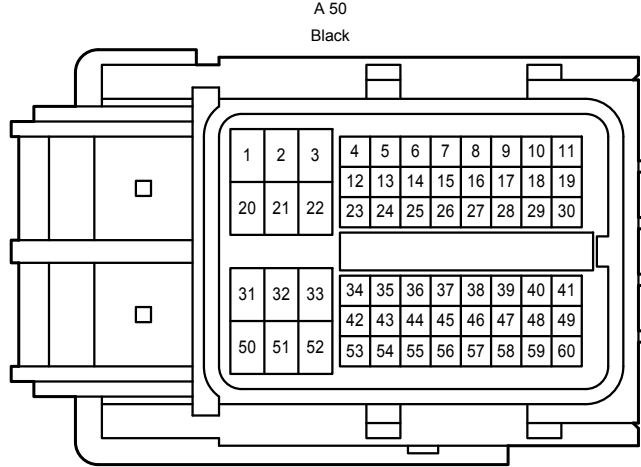
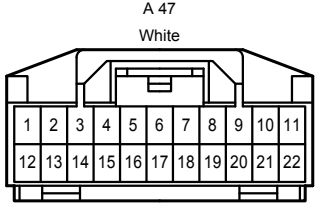
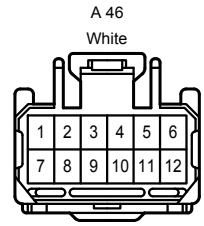
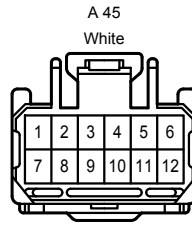
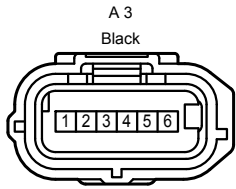
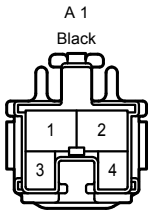

Cruise Control <2ZR-FE , Except TMC Made>

B 31  
Black

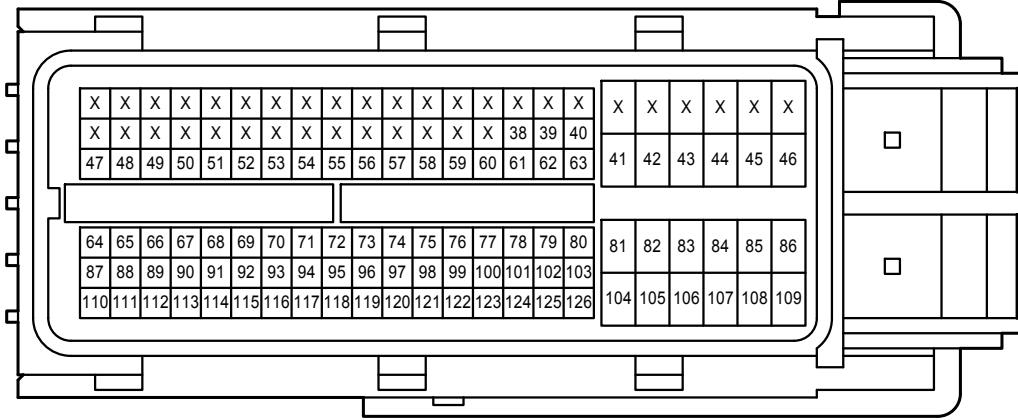

B 88  
Gray

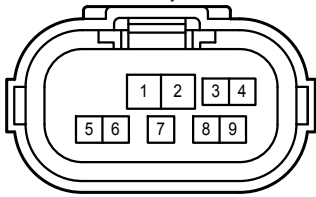

E 6  
Black

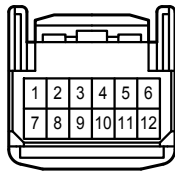

E 11  
White

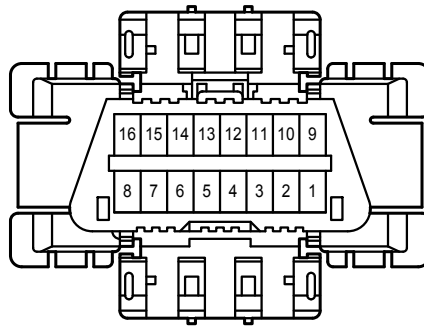

E 27  
White

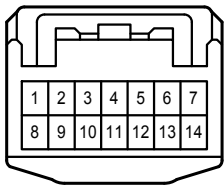

E 46  
White

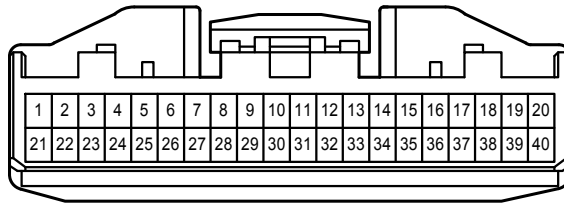

E 71  
White

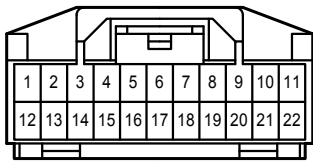

Y 2  
White

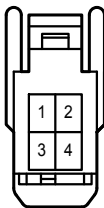

1B  
White

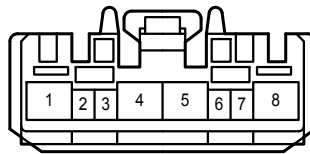

2B  
White

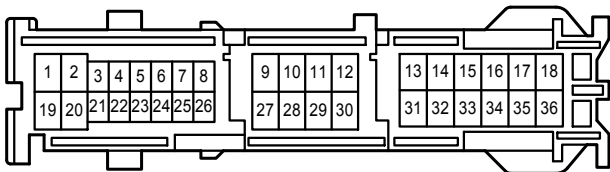

2C  
White

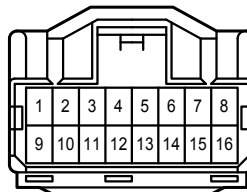

2D  
White

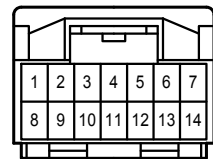

Cruise Control <2ZR-FE , Except TMC Made>

2E  
White

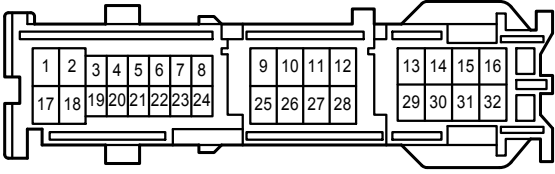

2M  
White

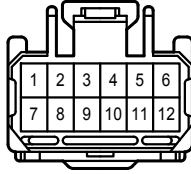

2S  
White

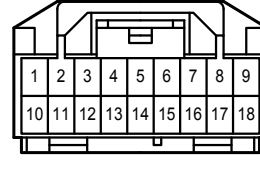

AE6  
Gray

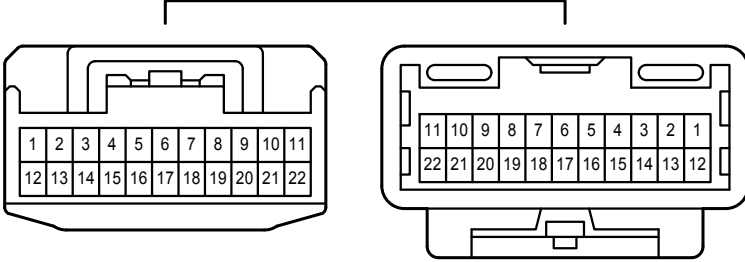

AE10  
Gray

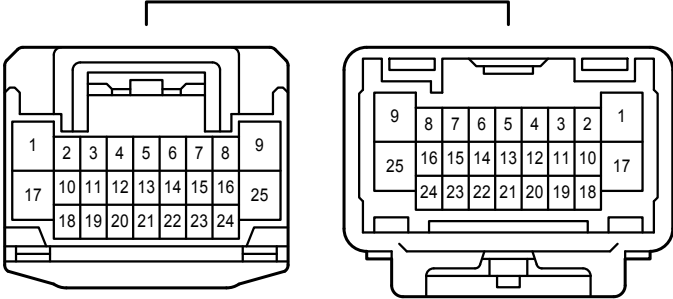

BA1  
White

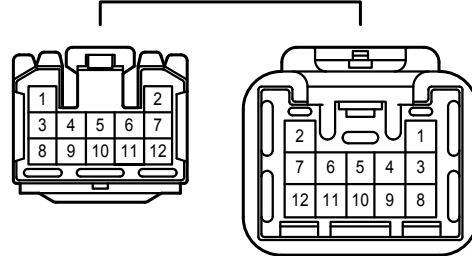

BA2  
White

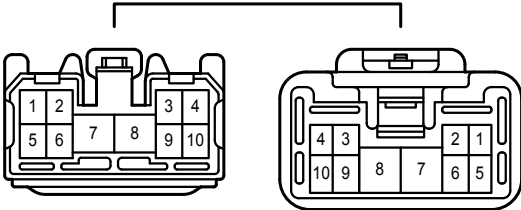

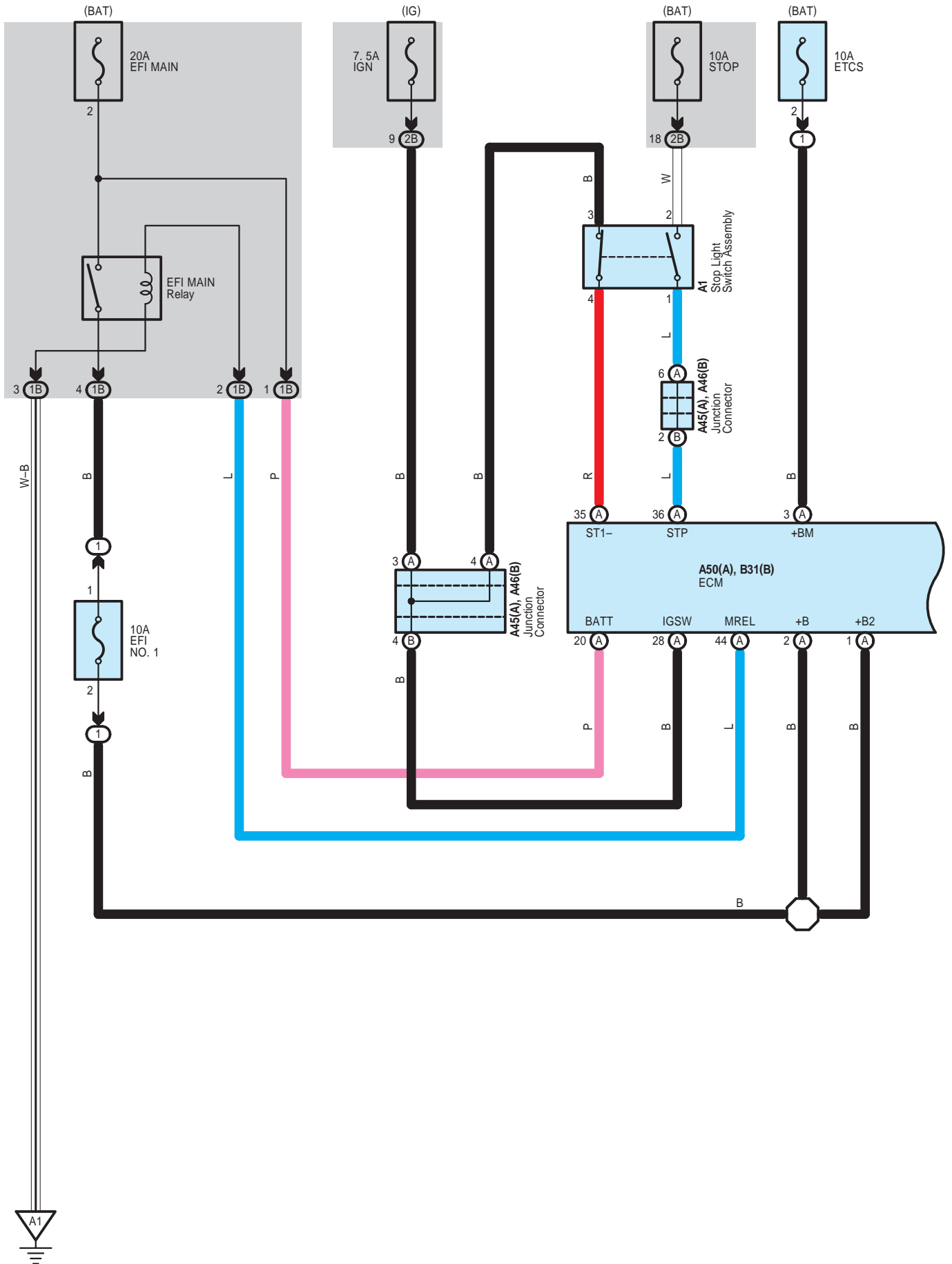

\* 1 : Shielded

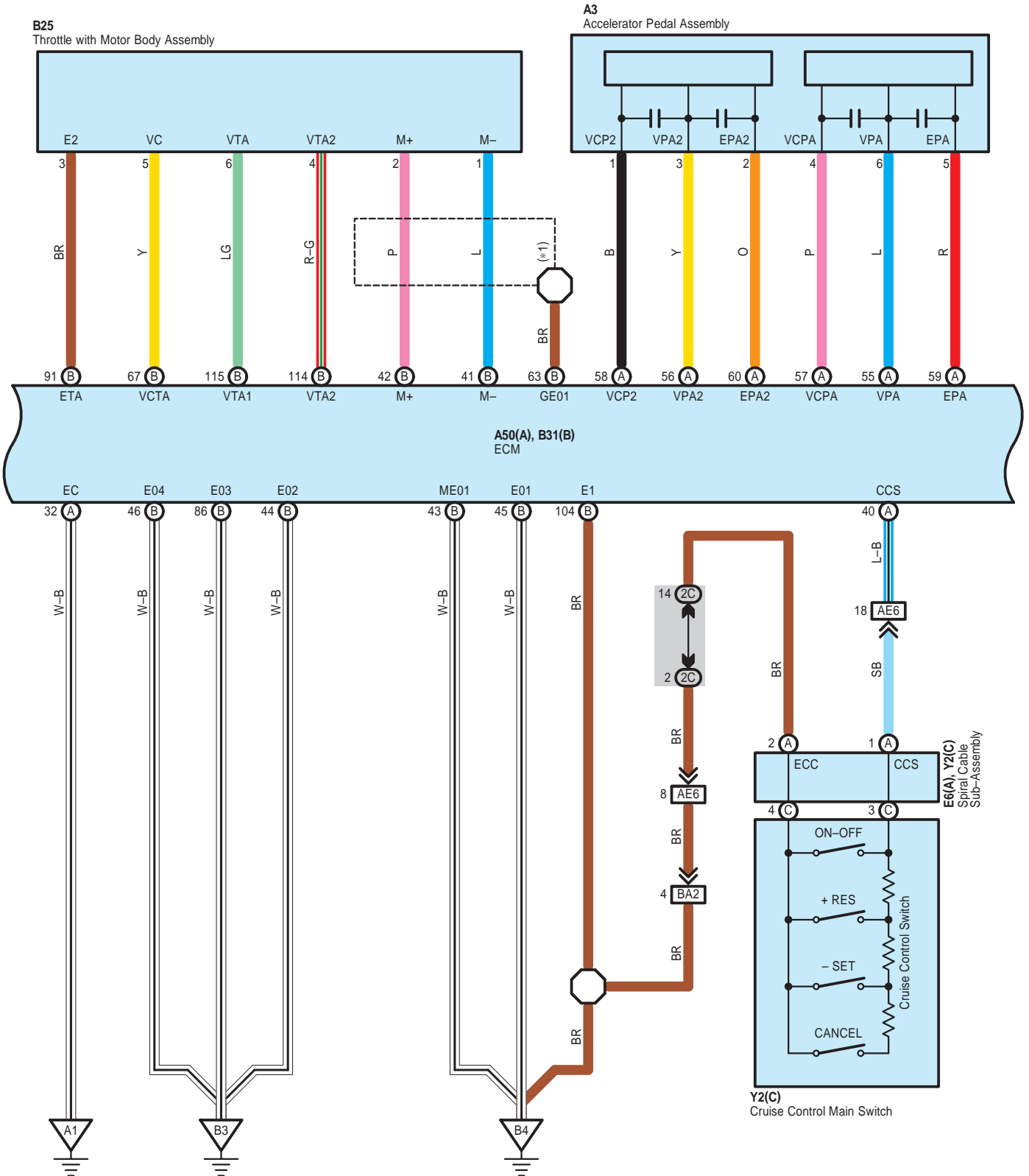

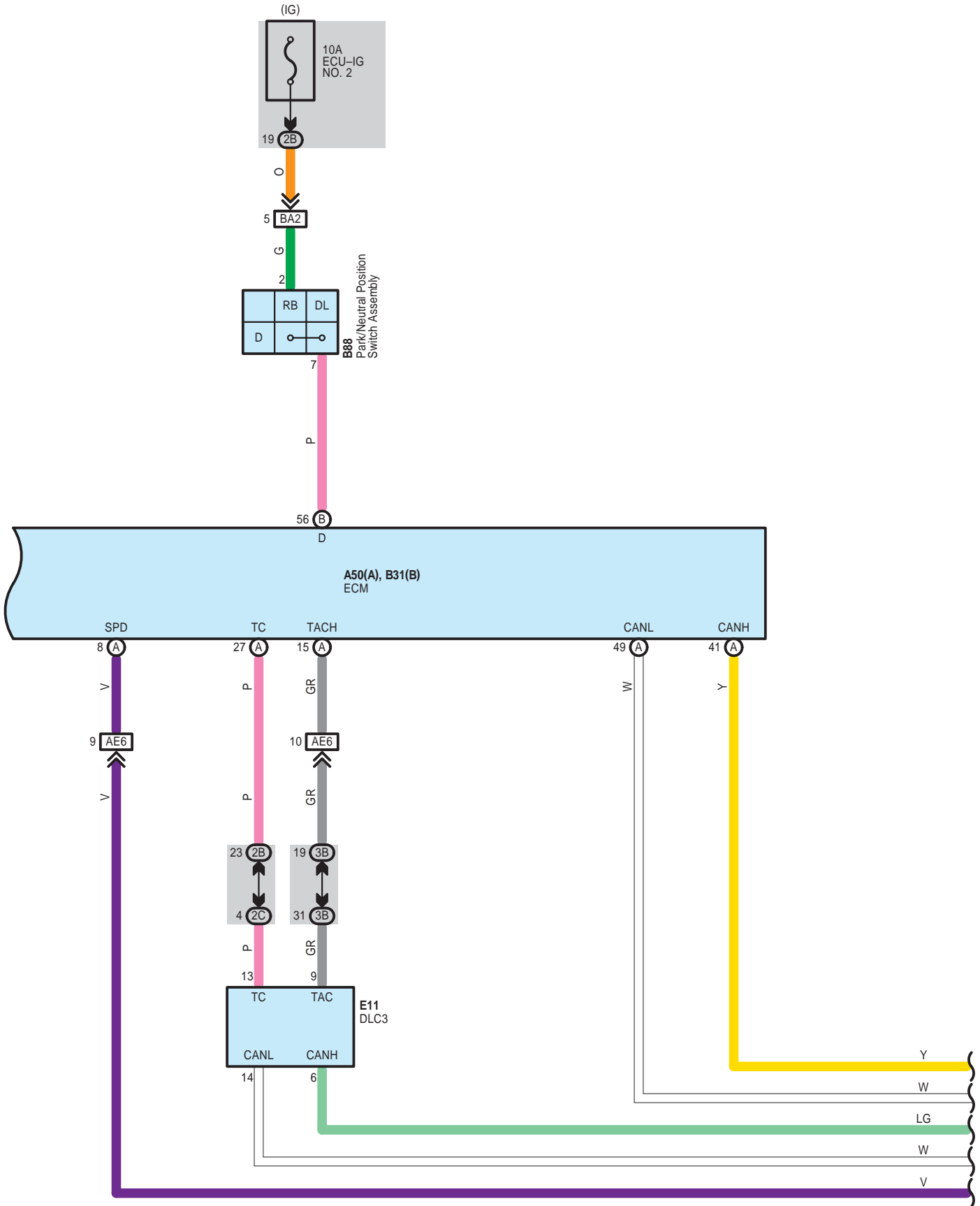

E58  
Junction Connector

A47  
Junction Connector

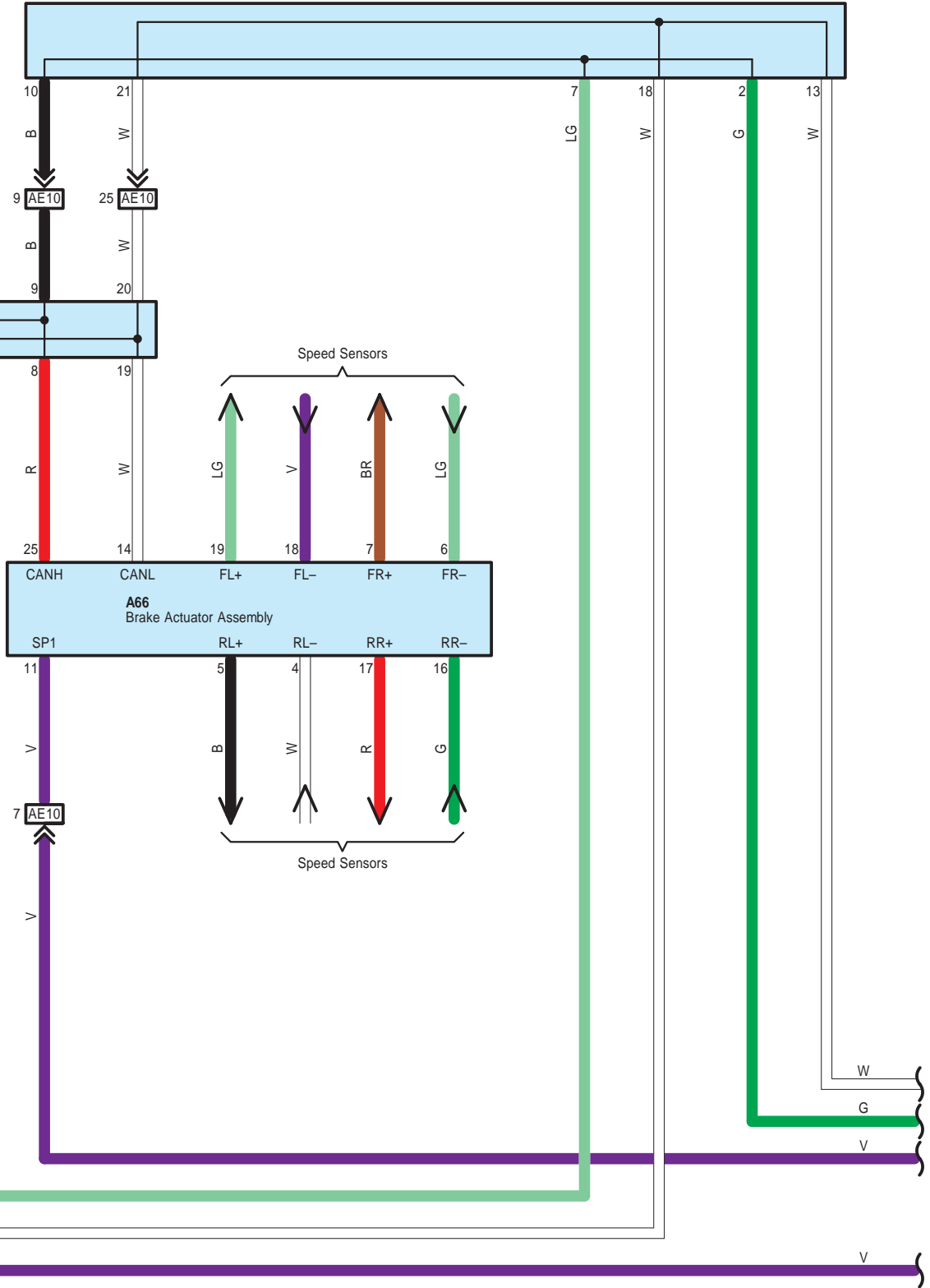



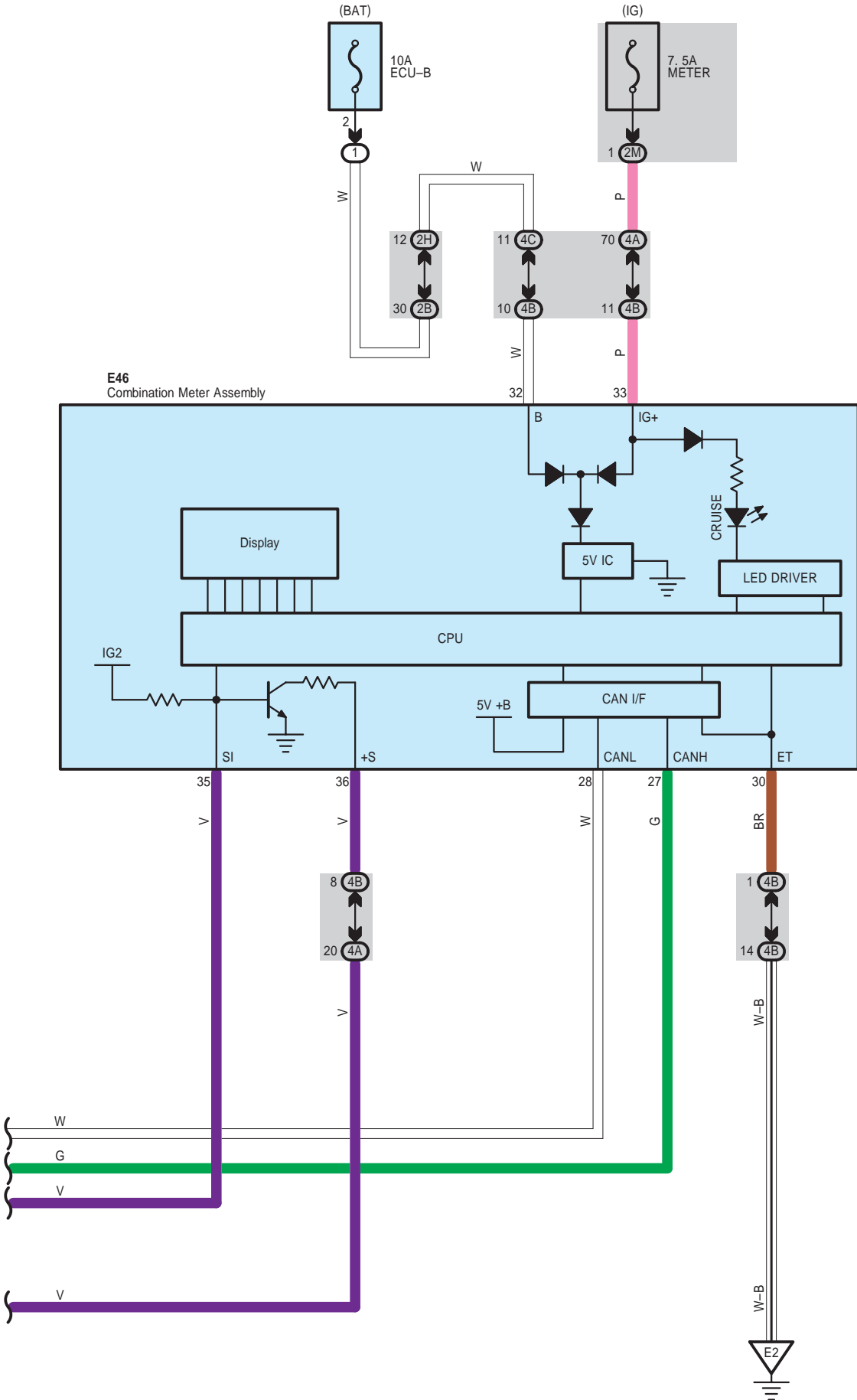

Cruise Control <TMC Made>

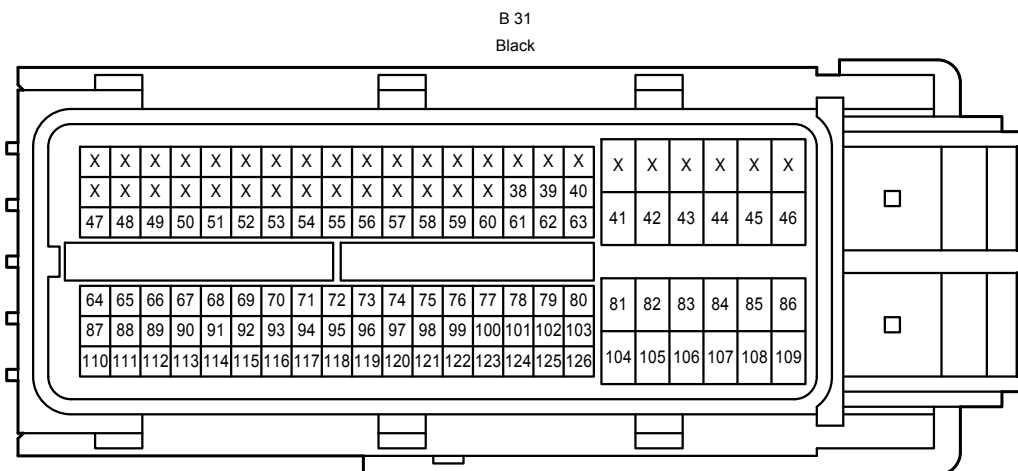
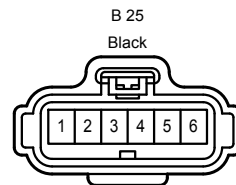
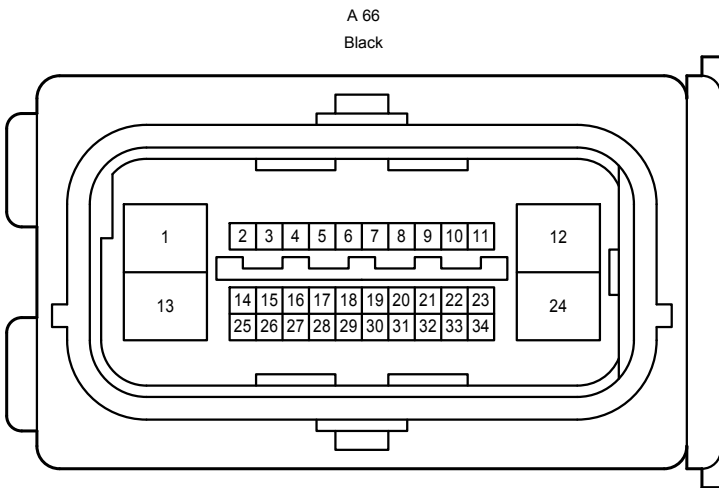
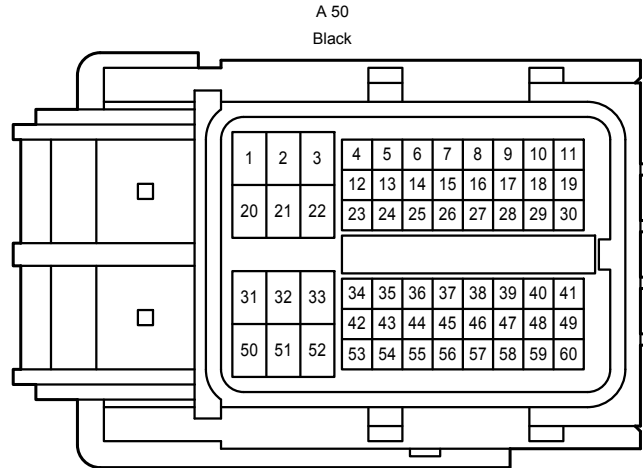
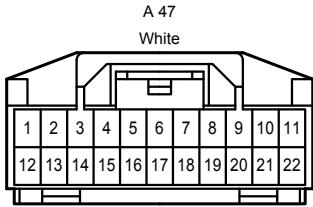
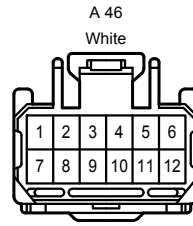
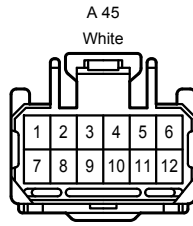
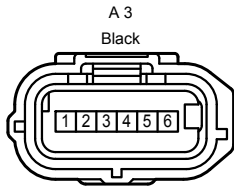
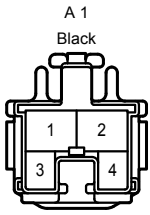

B 88  
Gray

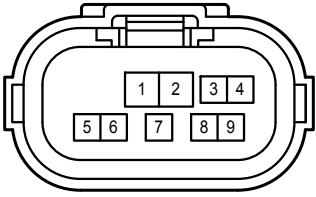

E 6  
Black

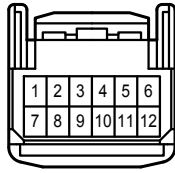

E 11  
White

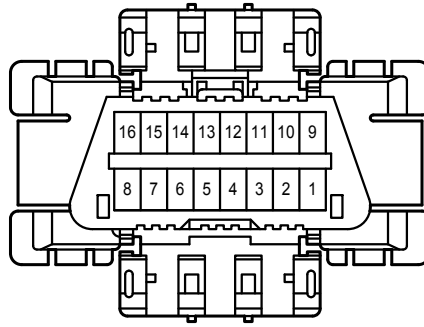

E 46  
White

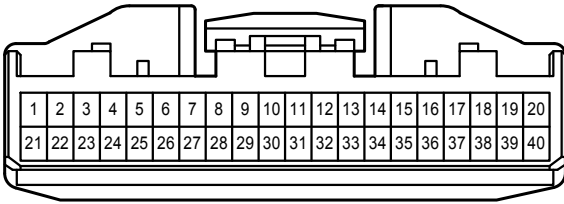

E 58  
Gray

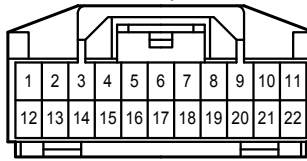

Y 2  
White

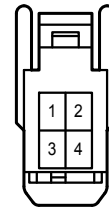

1B  
White

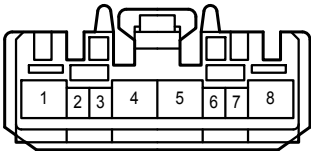

2B  
White

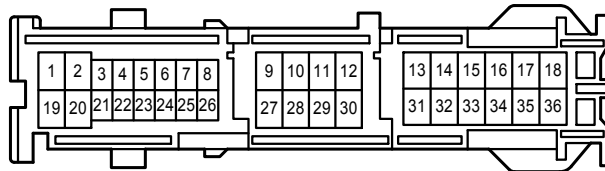

2C  
White

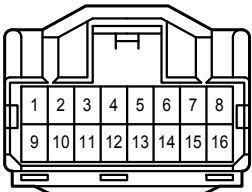

2H  
White

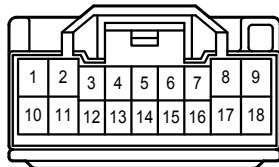

2M  
White

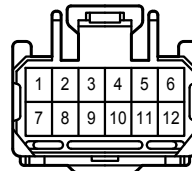

3B  
White

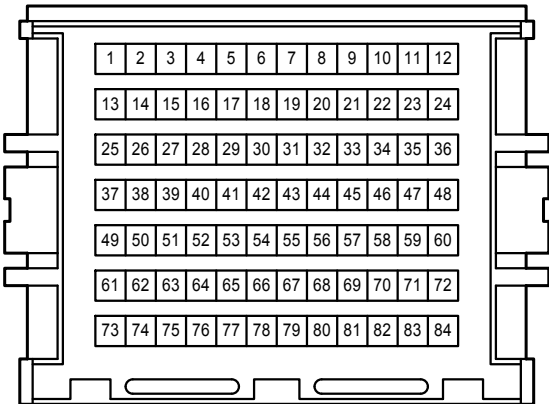

4A  
White

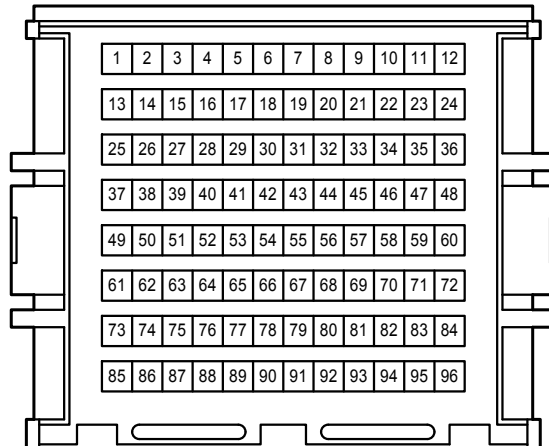

4B  
White

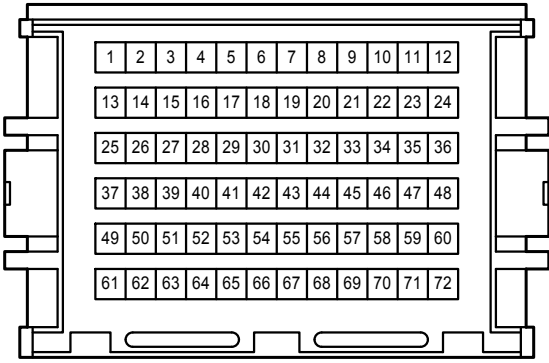

4C  
White

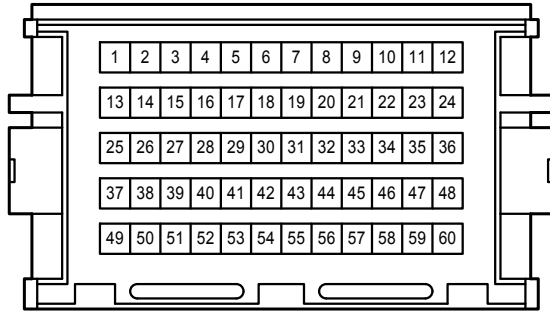

AE6  
Gray

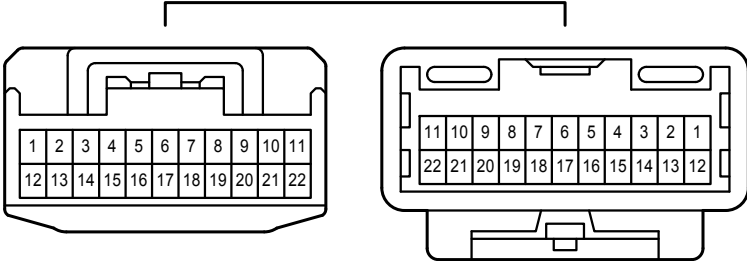

AE10  
Gray

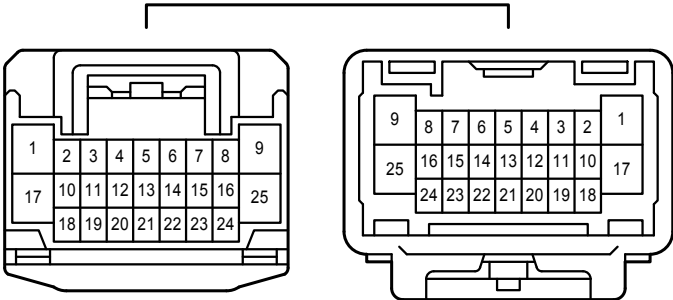

BA2  
White

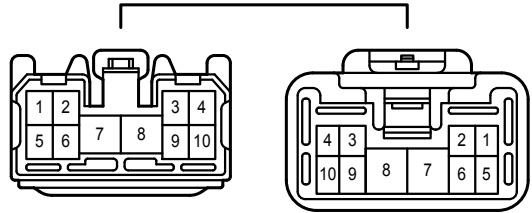

Data Link Connector 3 <Except TMC Made>

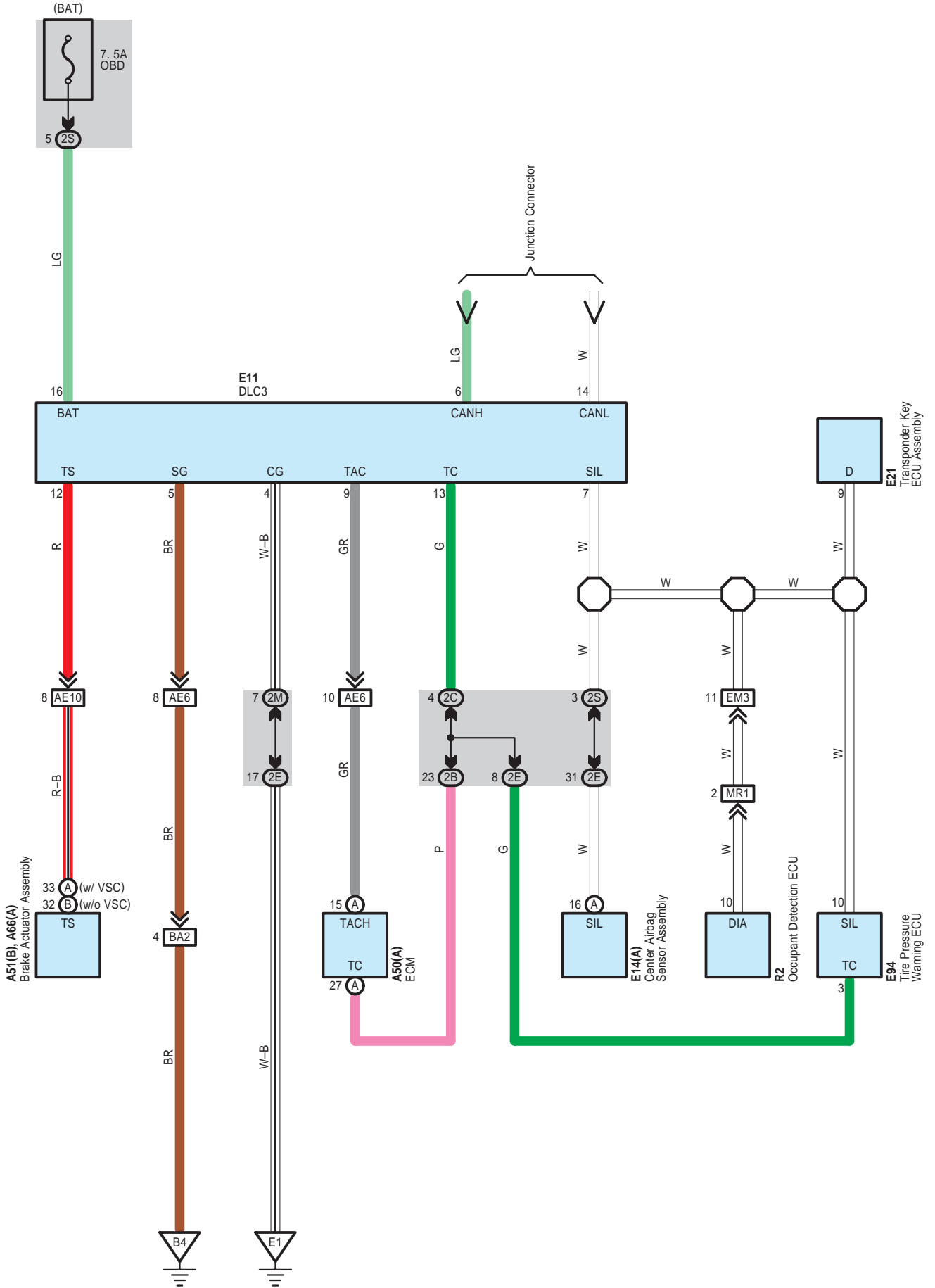

Data Link Connector 3 <Except TMC Made>

A 50  
Black

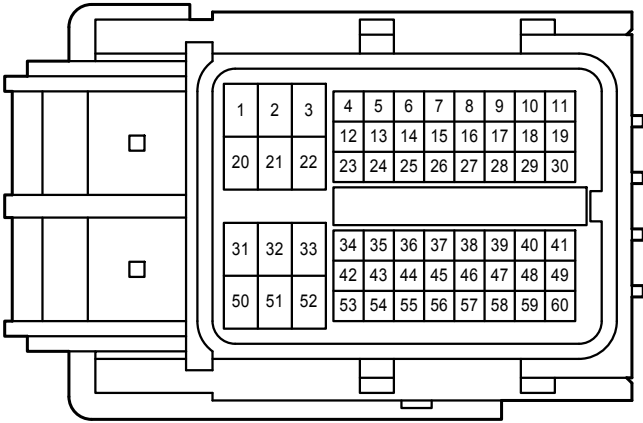

A 51  
Gray

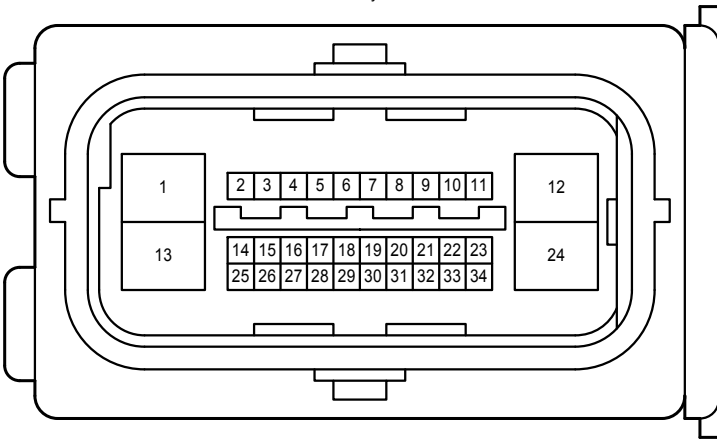

A 66  
Black

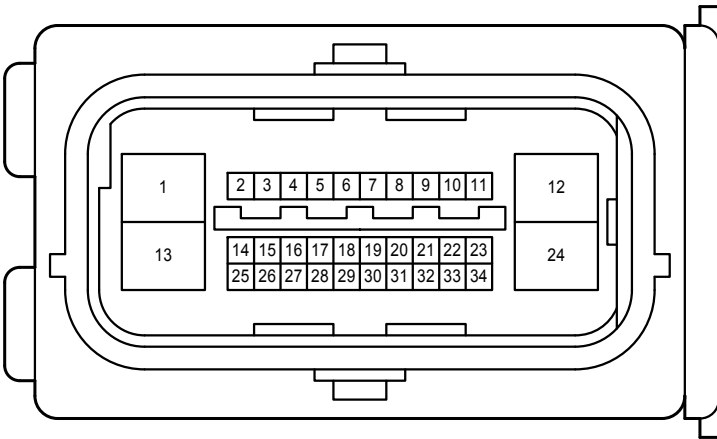

E 11  
White

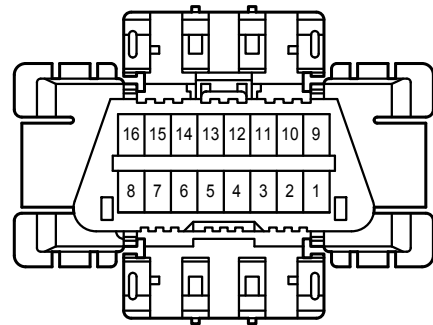

Data Link Connector 3 <Except TMC Made>

E 14  
Yellow

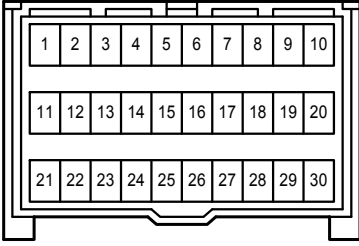

E 21  
White

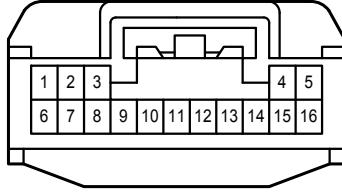

E 94  
Black

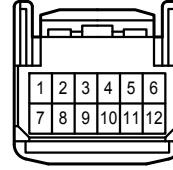

R 2  
Black

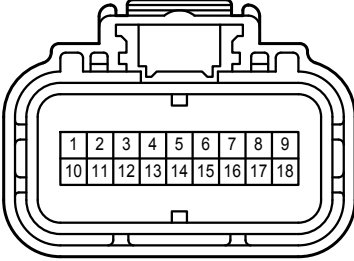

2B  
White

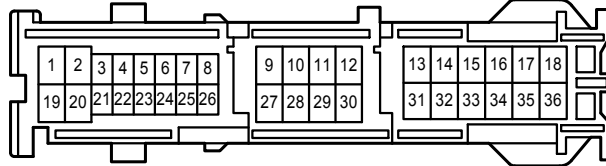

2C  
White

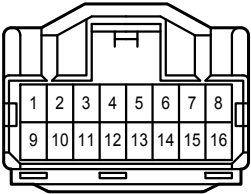

2E  
White

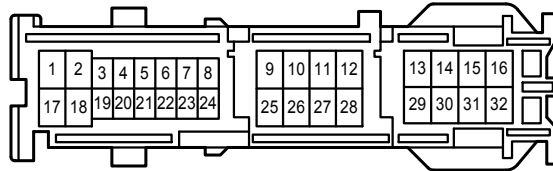

2M  
White

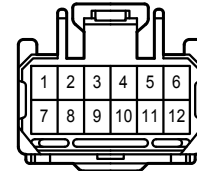

2S  
White

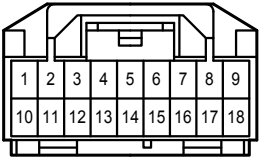

AE6  
Gray

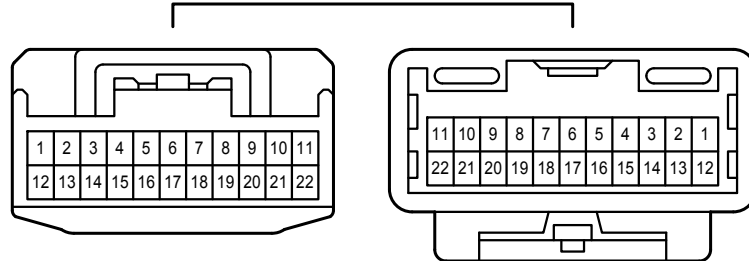

AE10  
Gray

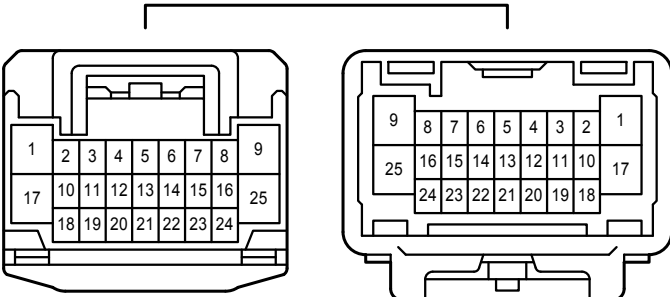

BA2  
White

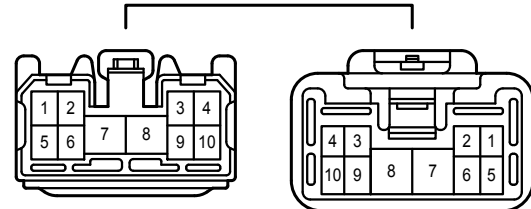

Data Link Connector 3 <Except TMC Made>

EM3  
White

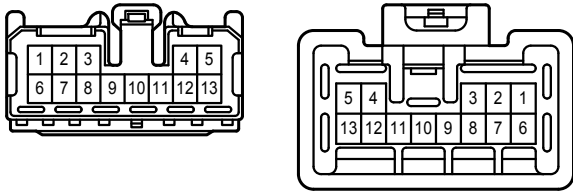

MR1  
Black

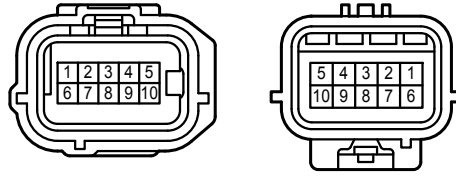



Data Link Connector 3 <TMC Made>

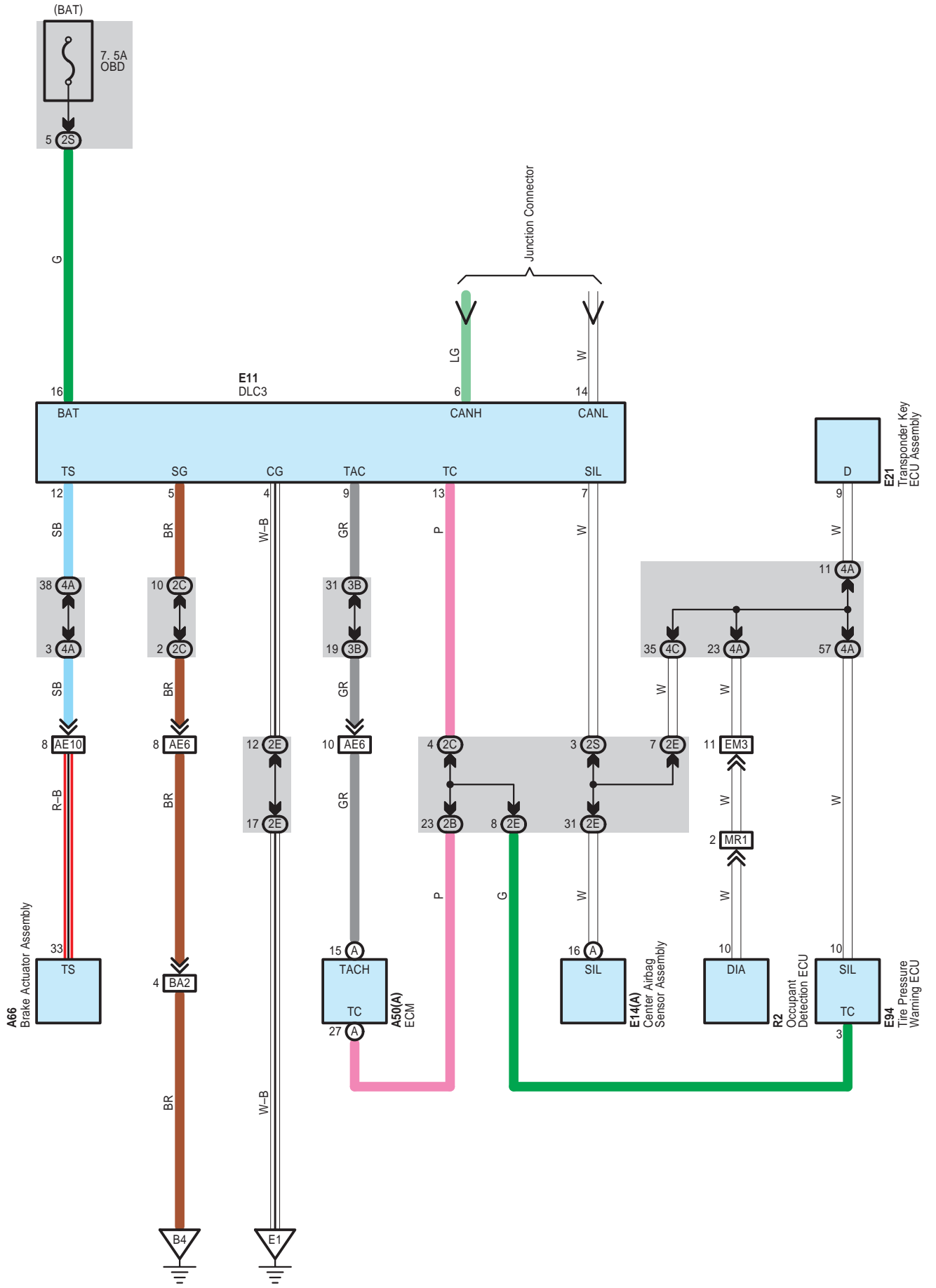

Data Link Connector 3 <TMC Made>

A 50  
Black

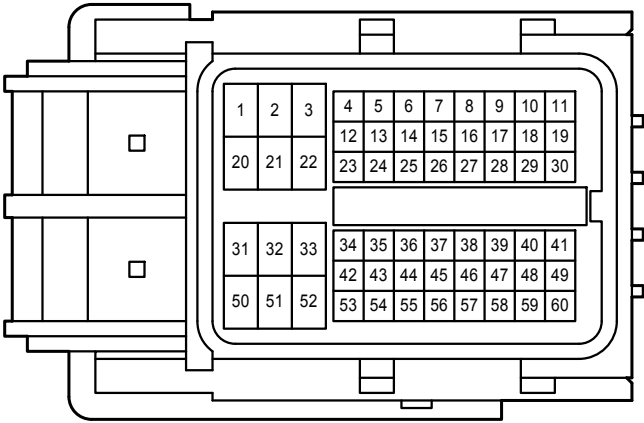

A 66  
Black

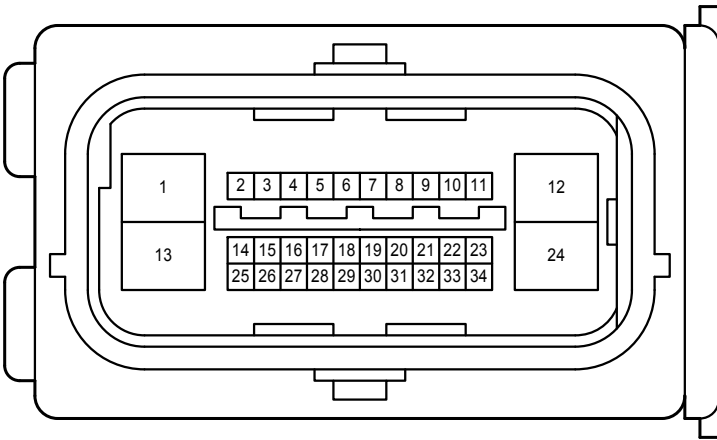

E 11  
White

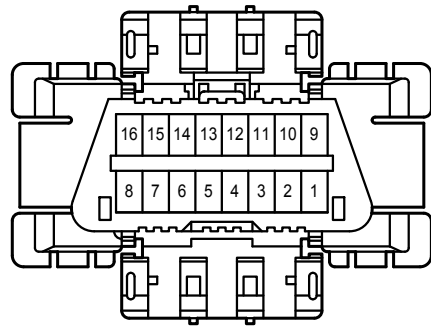

E 14  
Yellow

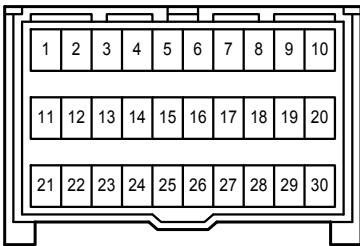

E 21  
White

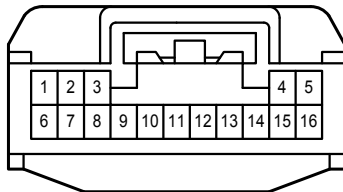

E 94  
Black

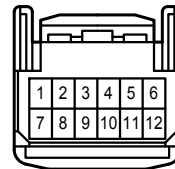

R 2  
Black

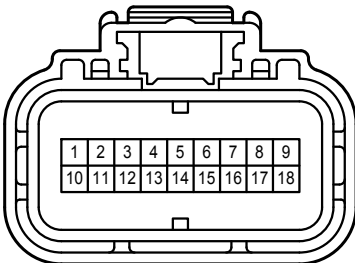

2B  
White

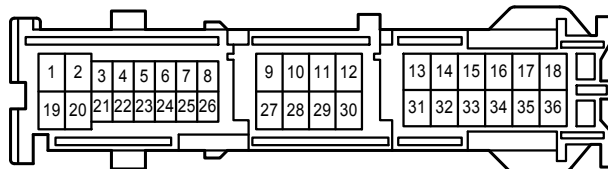

Data Link Connector 3 <TMC Made>

2C

White

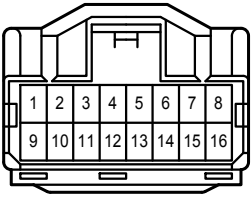

2E

White

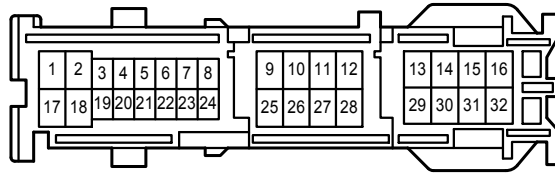

2S

White

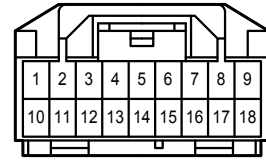

3B

White

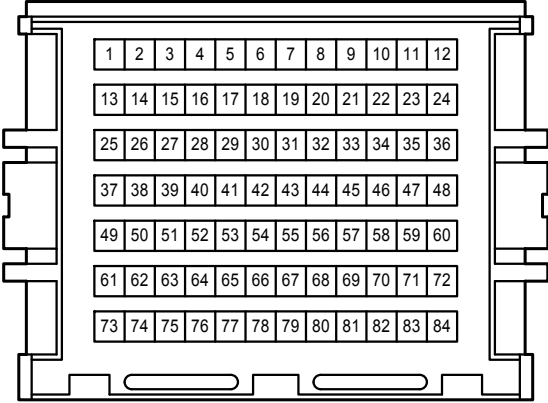

4A

White

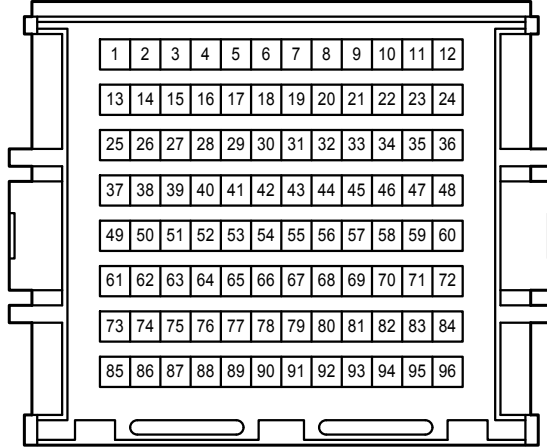

4C

White

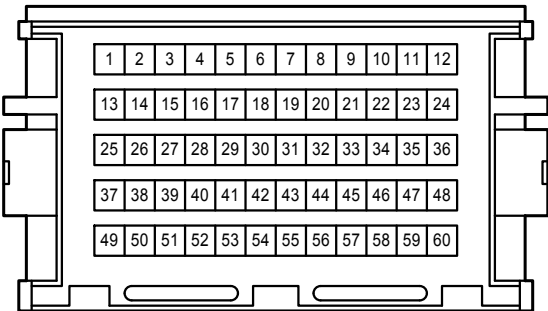

AE6  
Gray

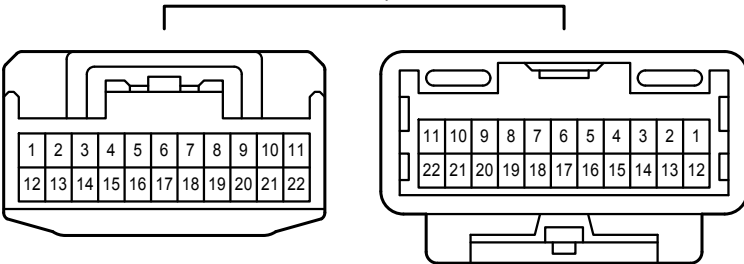

Data Link Connector 3 <TMC Made>

AE10  
Gray

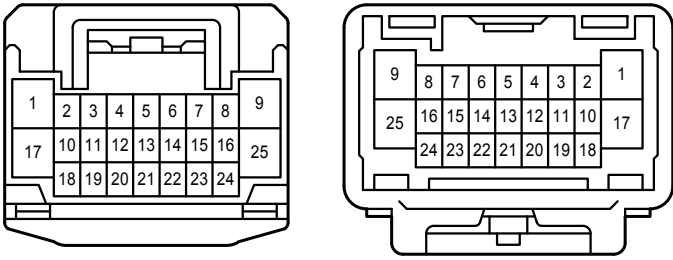

BA2  
White

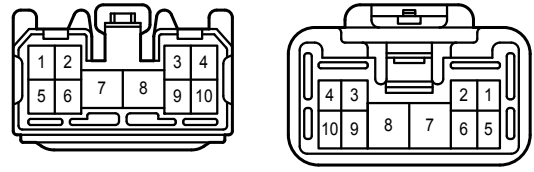

EM3  
White

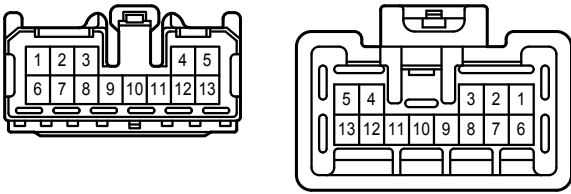

MR1  
Black

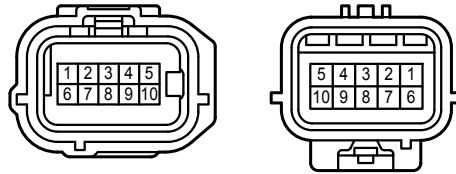

Door Lock Control <TMC Made>

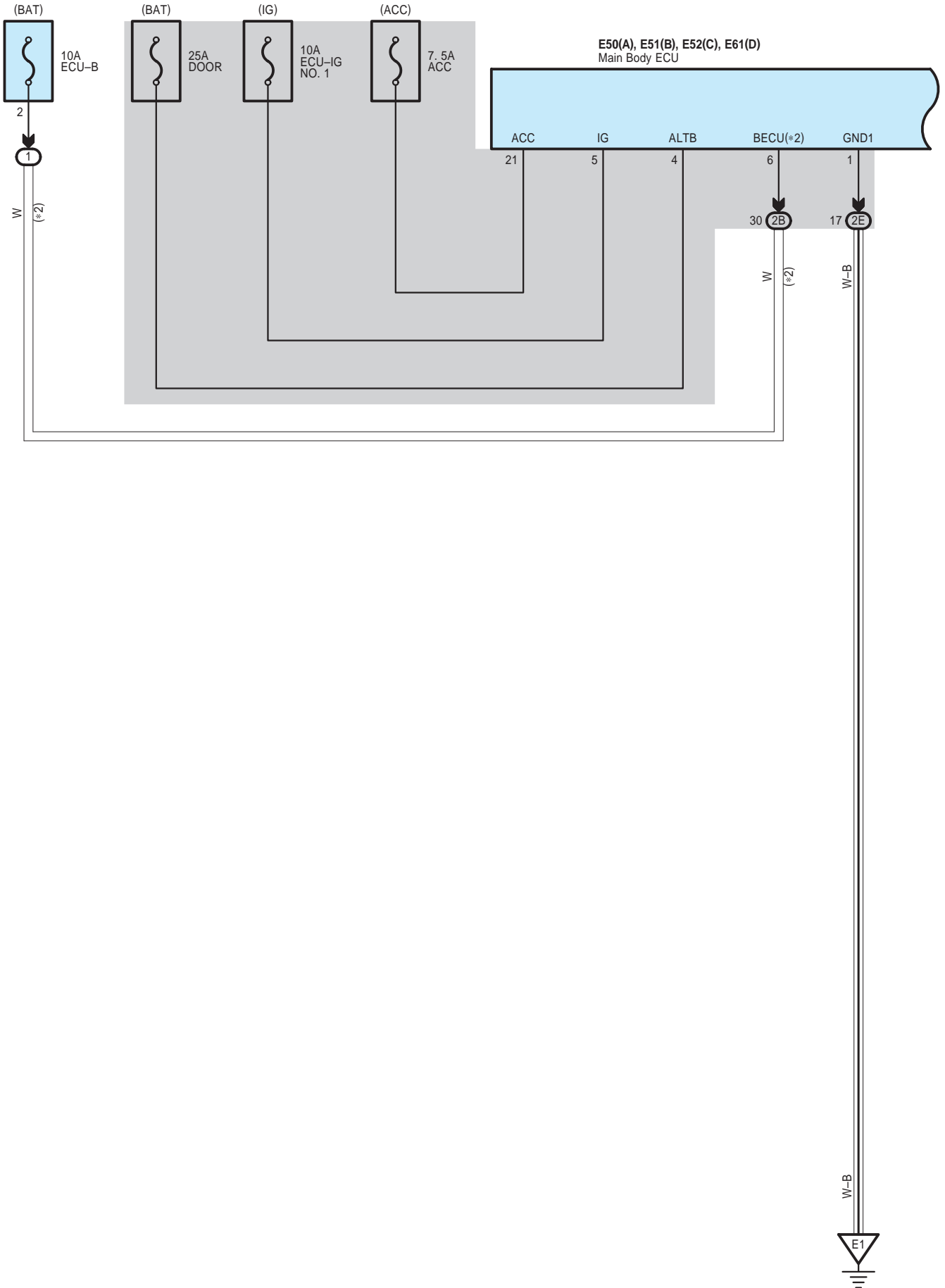

Door Lock Control <TMC Made>

\* 1 : w/ Smart Key System  
 \* 2 : w/o Smart Key System

E50(A), E51(B), E52(C), E61(D)  
 Main Body ECU

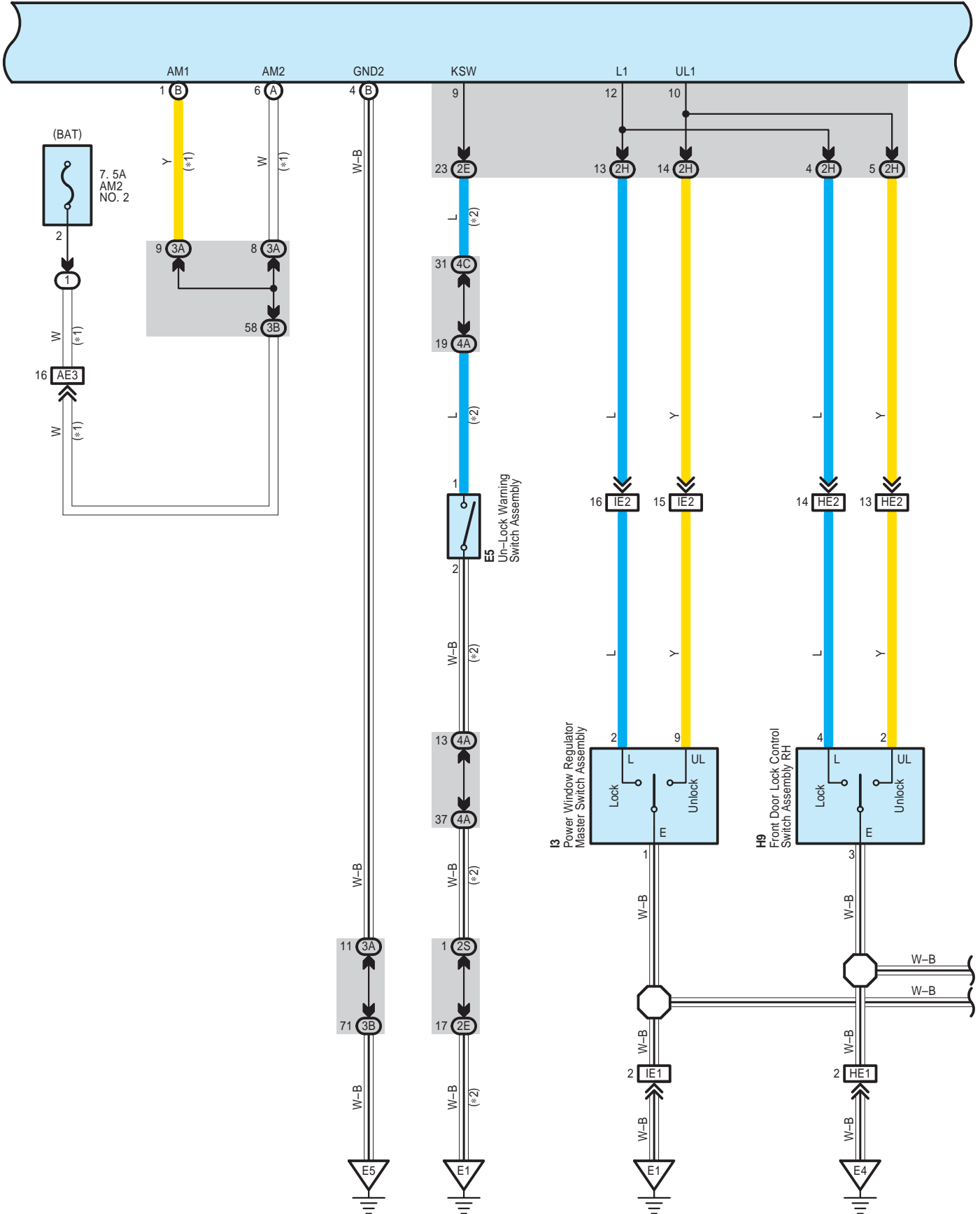

Door Lock Control <TMC Made>

E50(A), E51(B), E52(C), E61(D)  
Main Body ECU

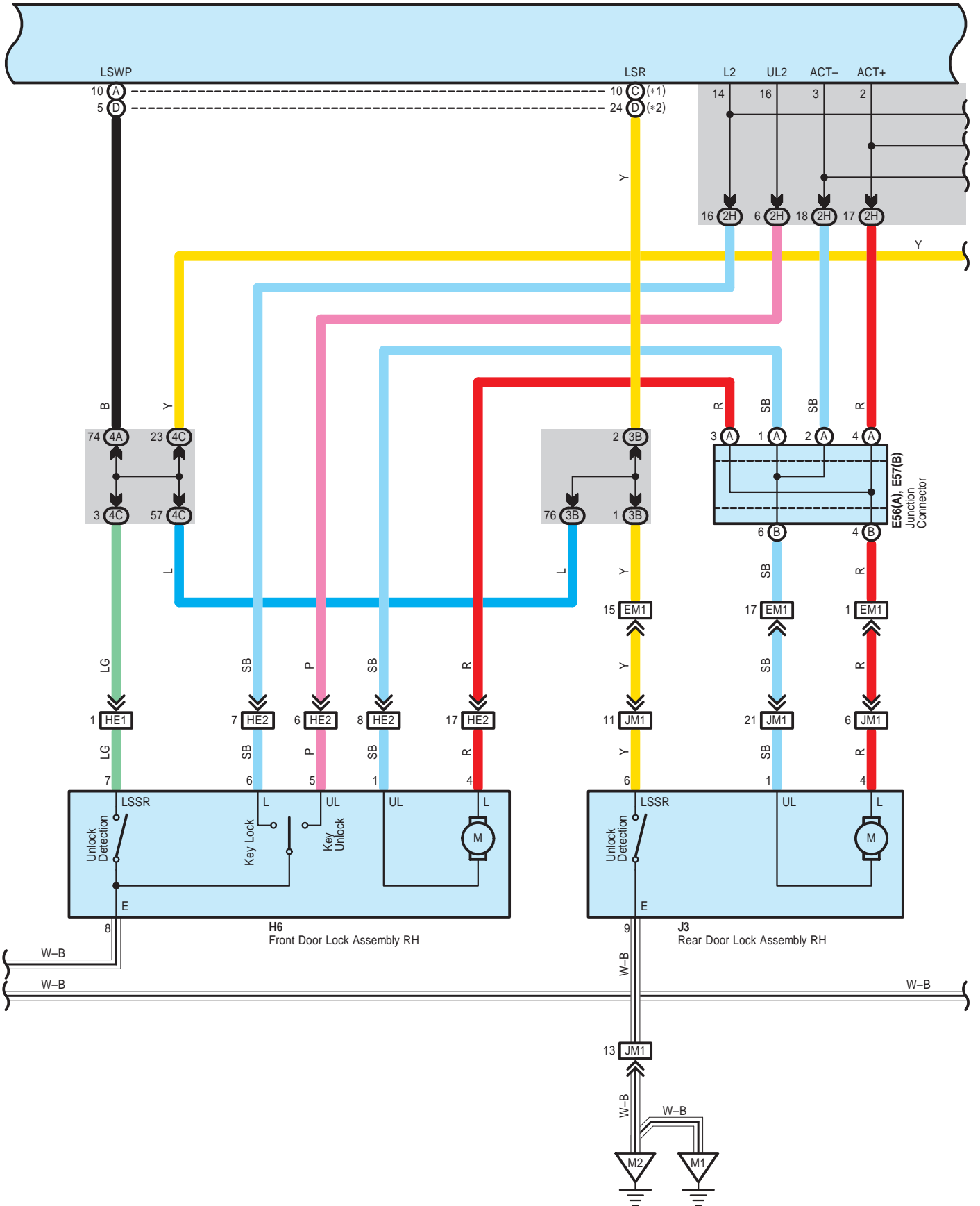

Door Lock Control <TMC Made>

- \* 1 : w/ Smart Key System
- \* 2 : w/o Smart Key System

E50(A), E51(B), E52(C), E61(D)  
Main Body ECU

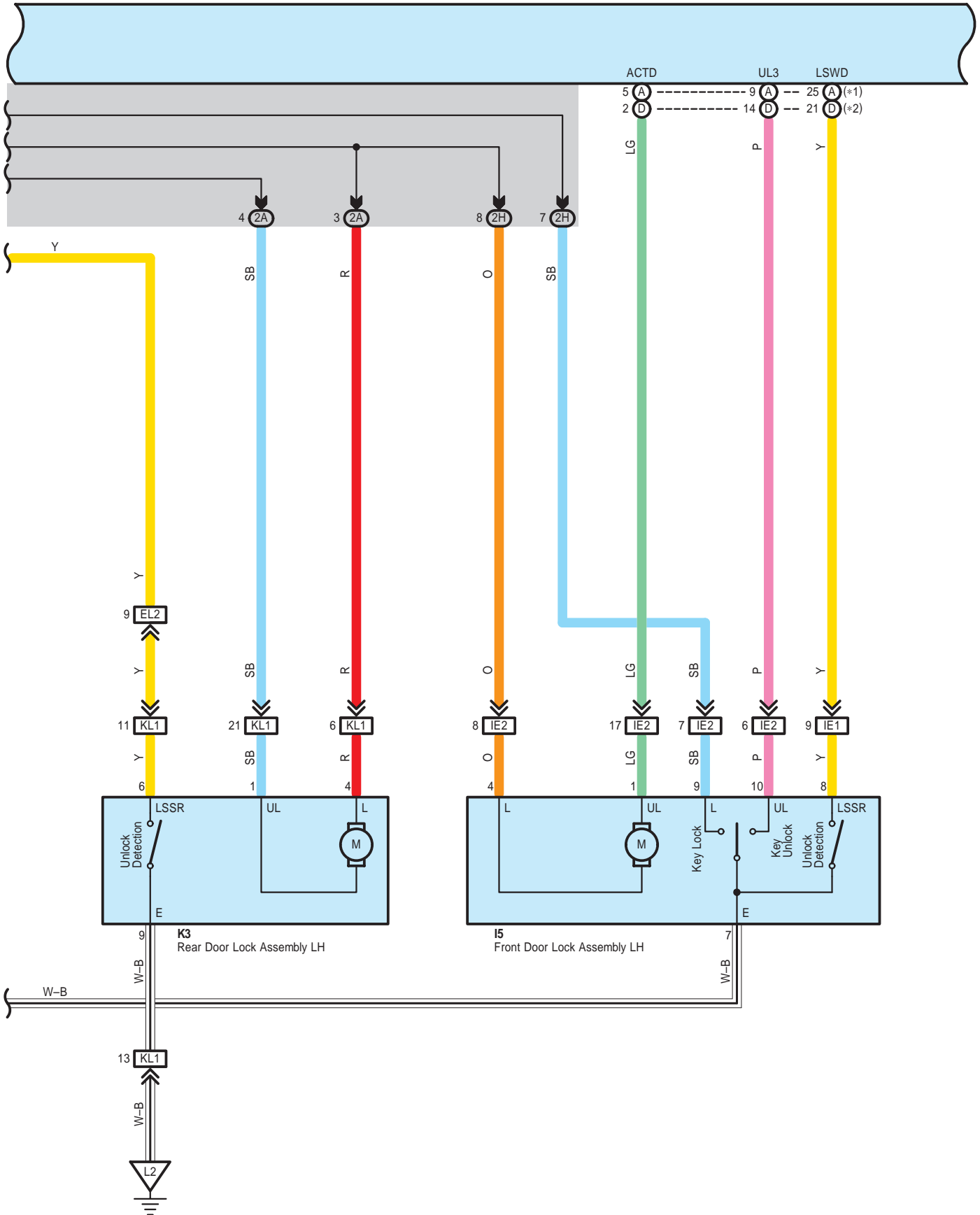



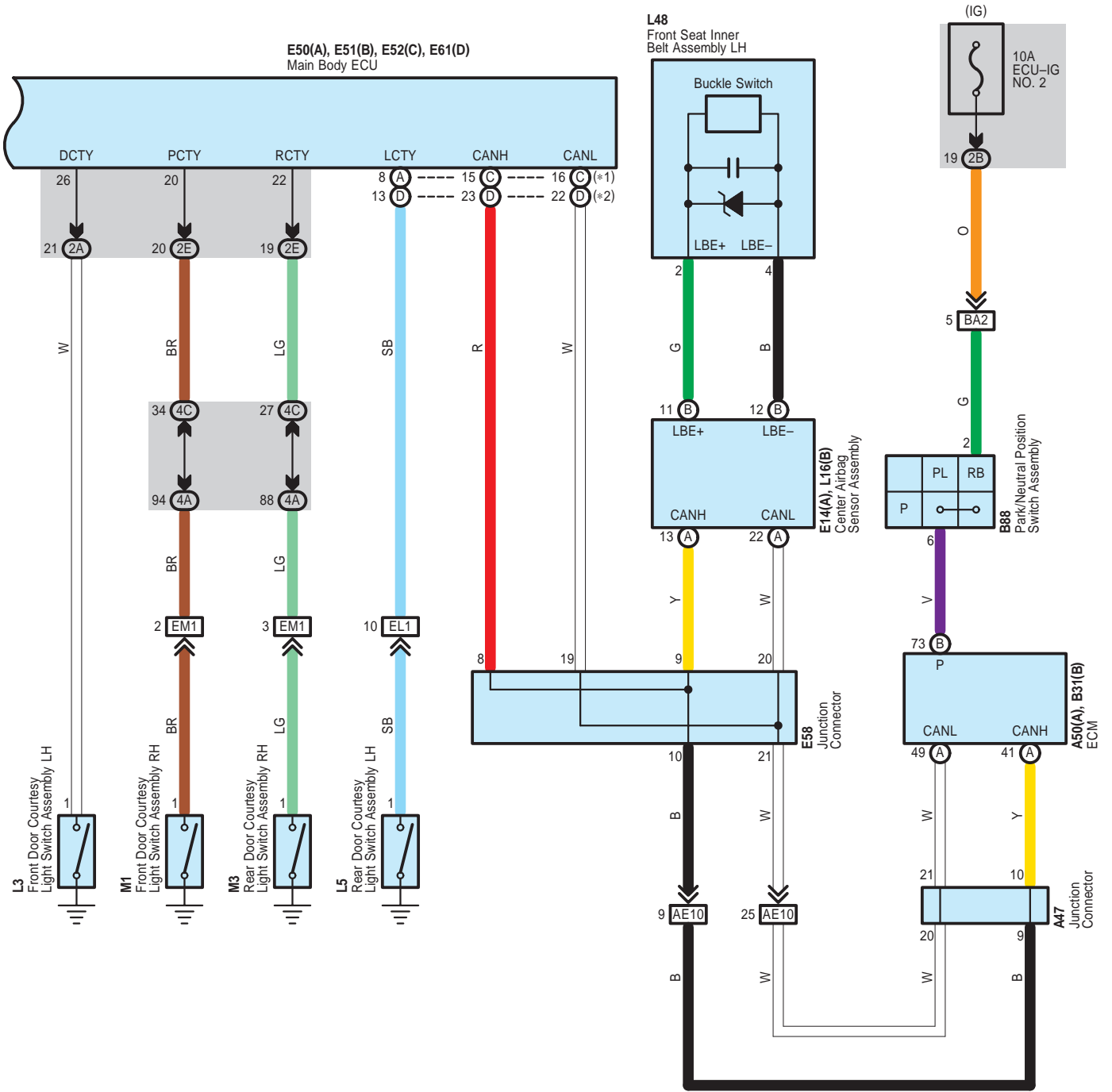

\* 1 : w/ Smart Key System  
 \* 2 : w/o Smart Key System

Door Lock Control <TMC Made>

A 47  
White

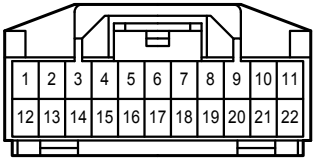

A 50  
Black

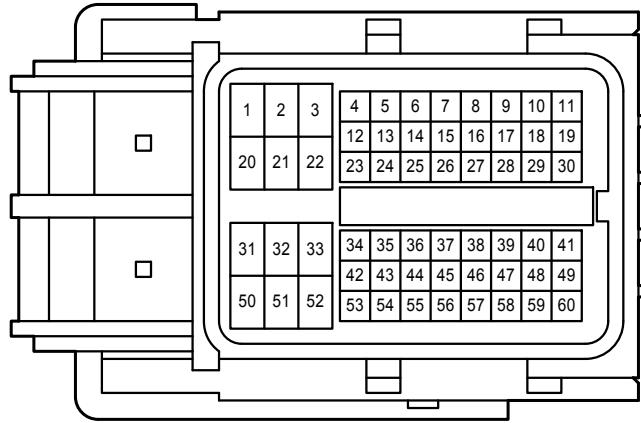

B 31  
Black

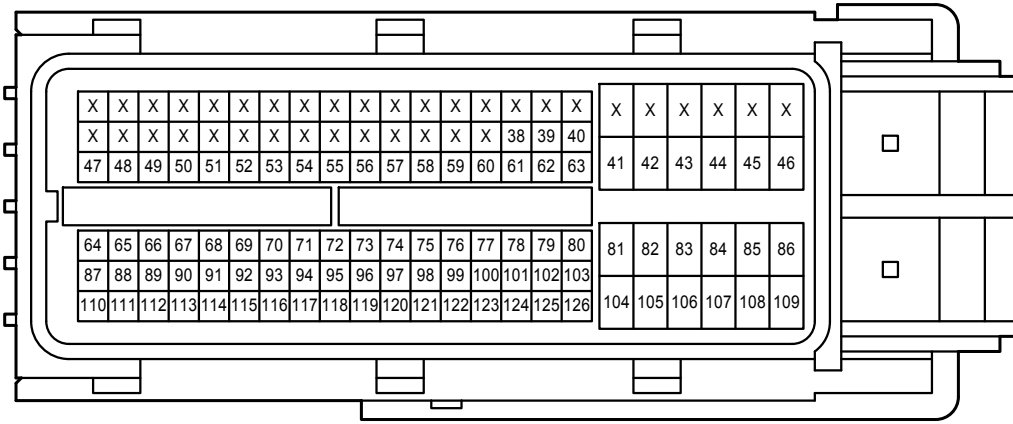

B 88  
Gray

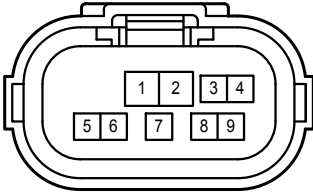

E 5  
White



E 14  
Yellow

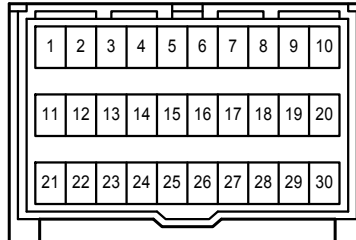

E 50  
White

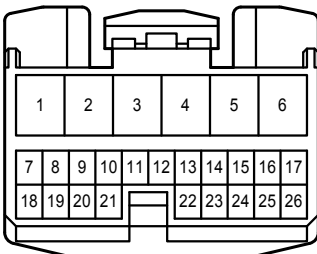

E 51  
White

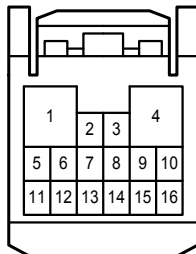

E 52  
White

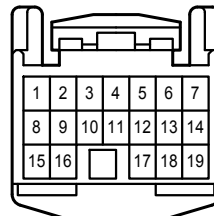

E 56  
White

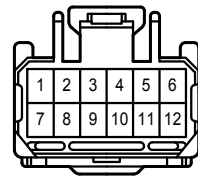

Door Lock Control <TMC Made>

E 57

White

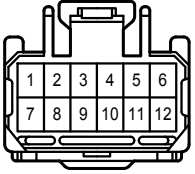

E 58

Gray

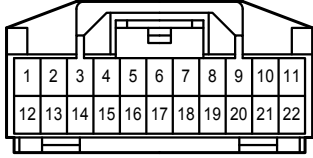

E 61

White

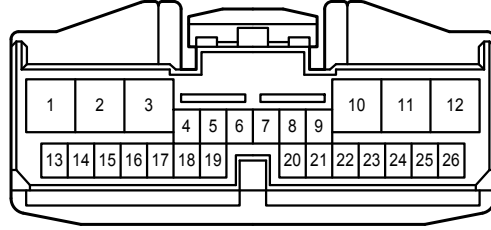

H 6

White

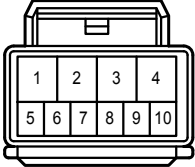

H 9

White

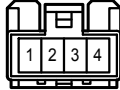

I 3

White

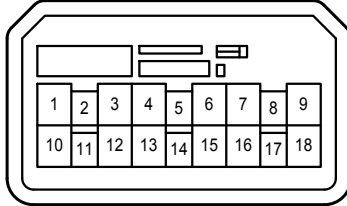

I 5

White

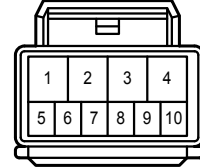

J 3

White

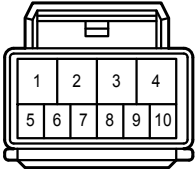

K 3

White

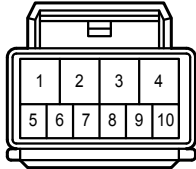

L 3

Black



L 5

Black



L 16

Yellow

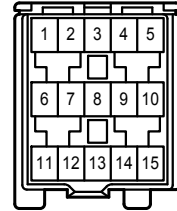

L 48

White



M 1

Black



M 3

Black



2A

White

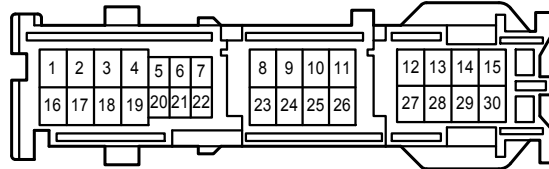

2B

White

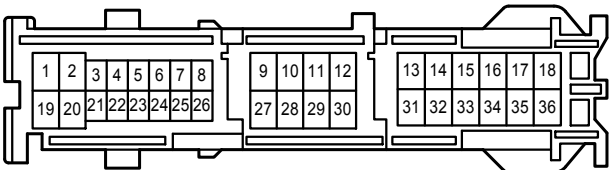

2E

White

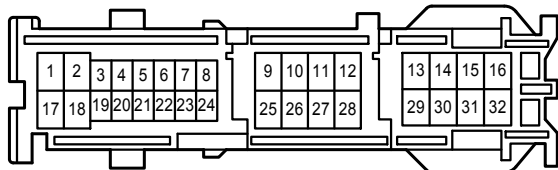

Door Lock Control <TMC Made>

2H  
White

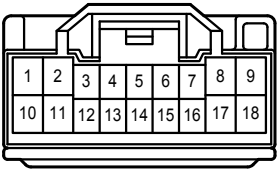

2S  
White

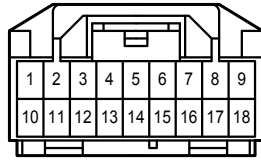

3A  
White

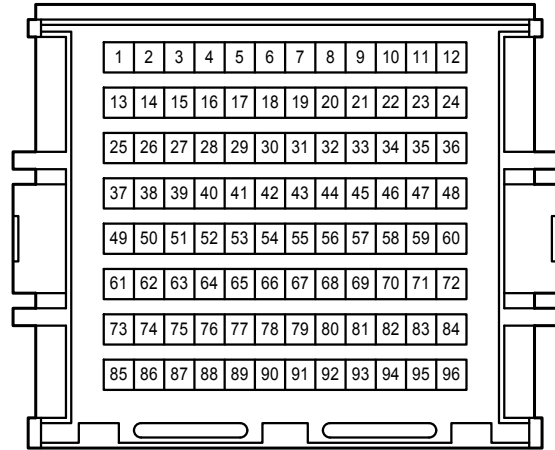

3B  
White

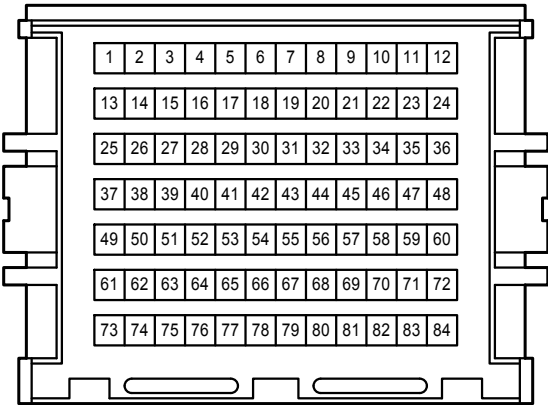

4A  
White

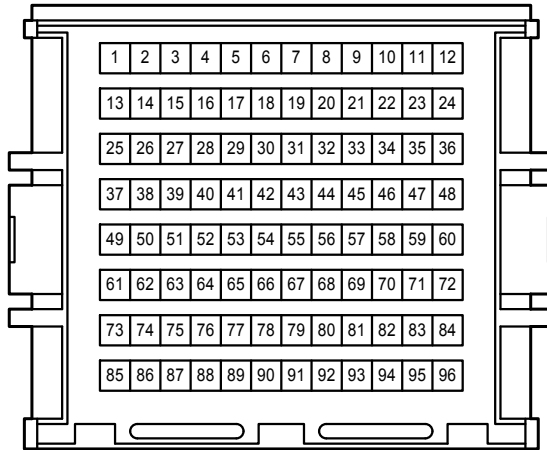

4C  
White

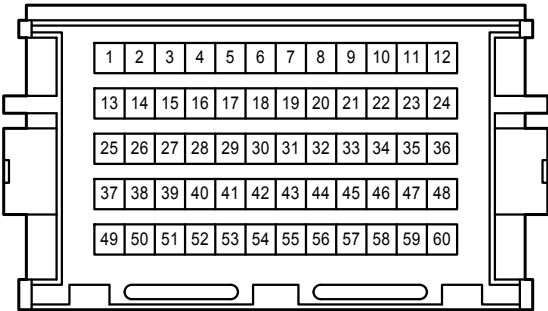

AE3  
White

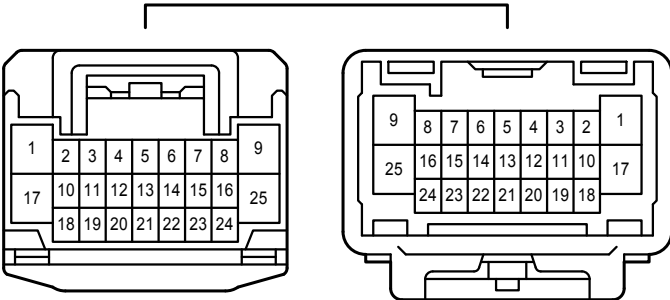

AE10  
Gray

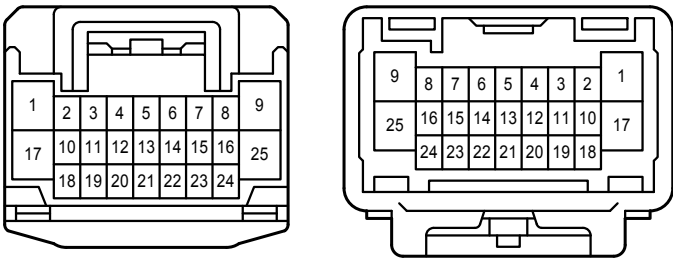

BA2  
White

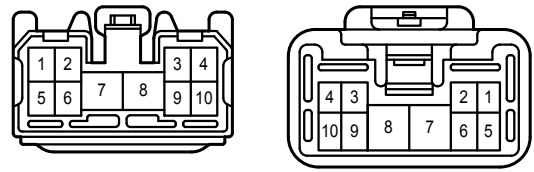

EL1  
White

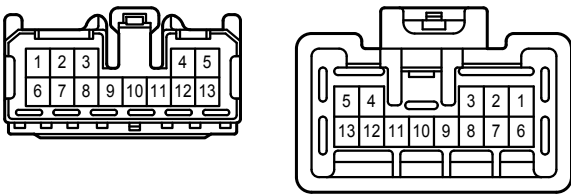

EL2  
White

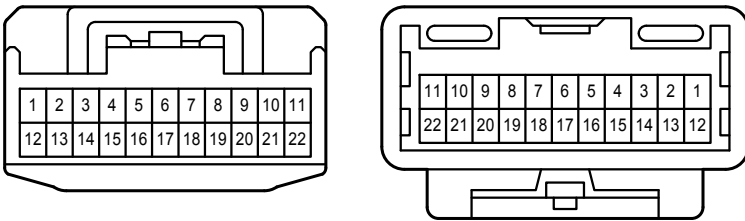

EM1  
Gray

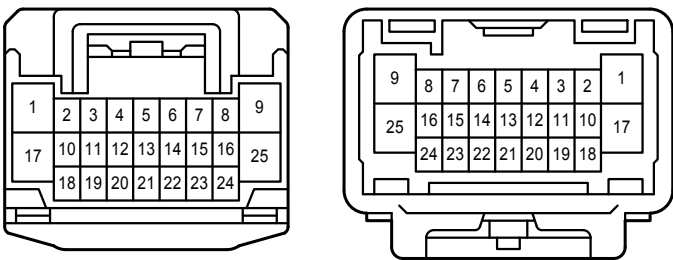

HE1  
Blue

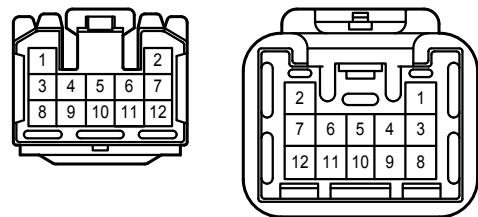

HE2  
White

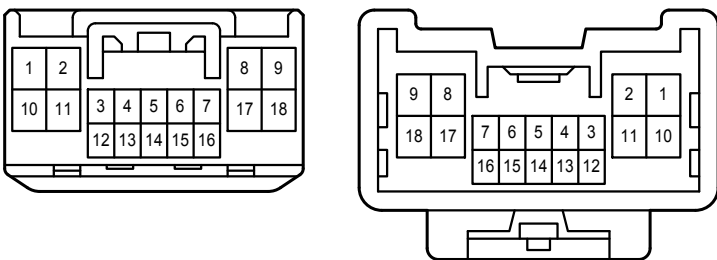

IE1  
Blue

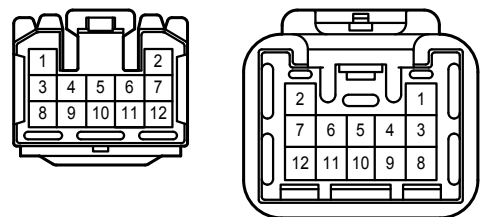

IE2  
White

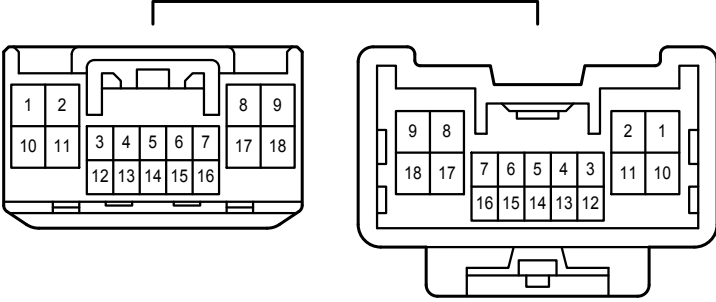

JM1  
White

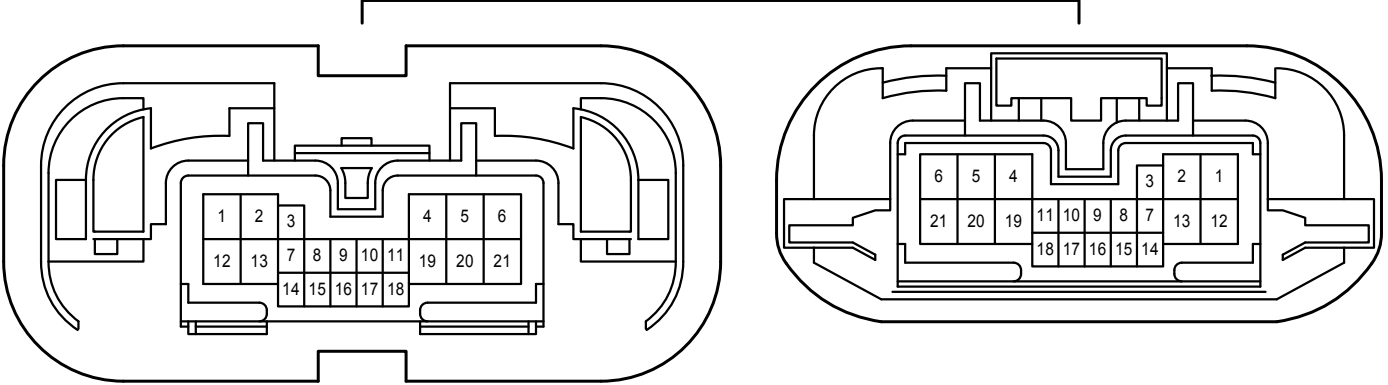

KL1  
White

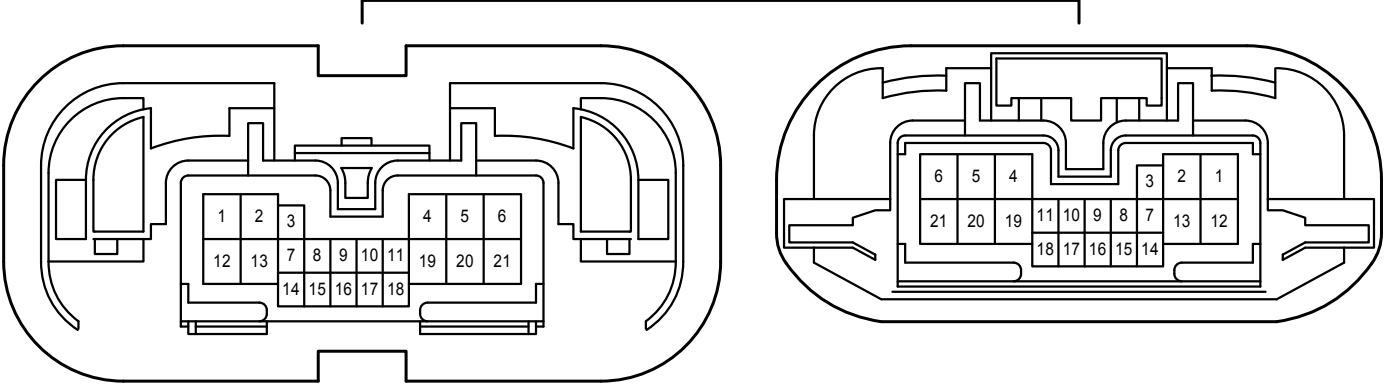

Electronically Controlled Transmission and A/T Indicator <2AZ-FE , Except TMC Made>

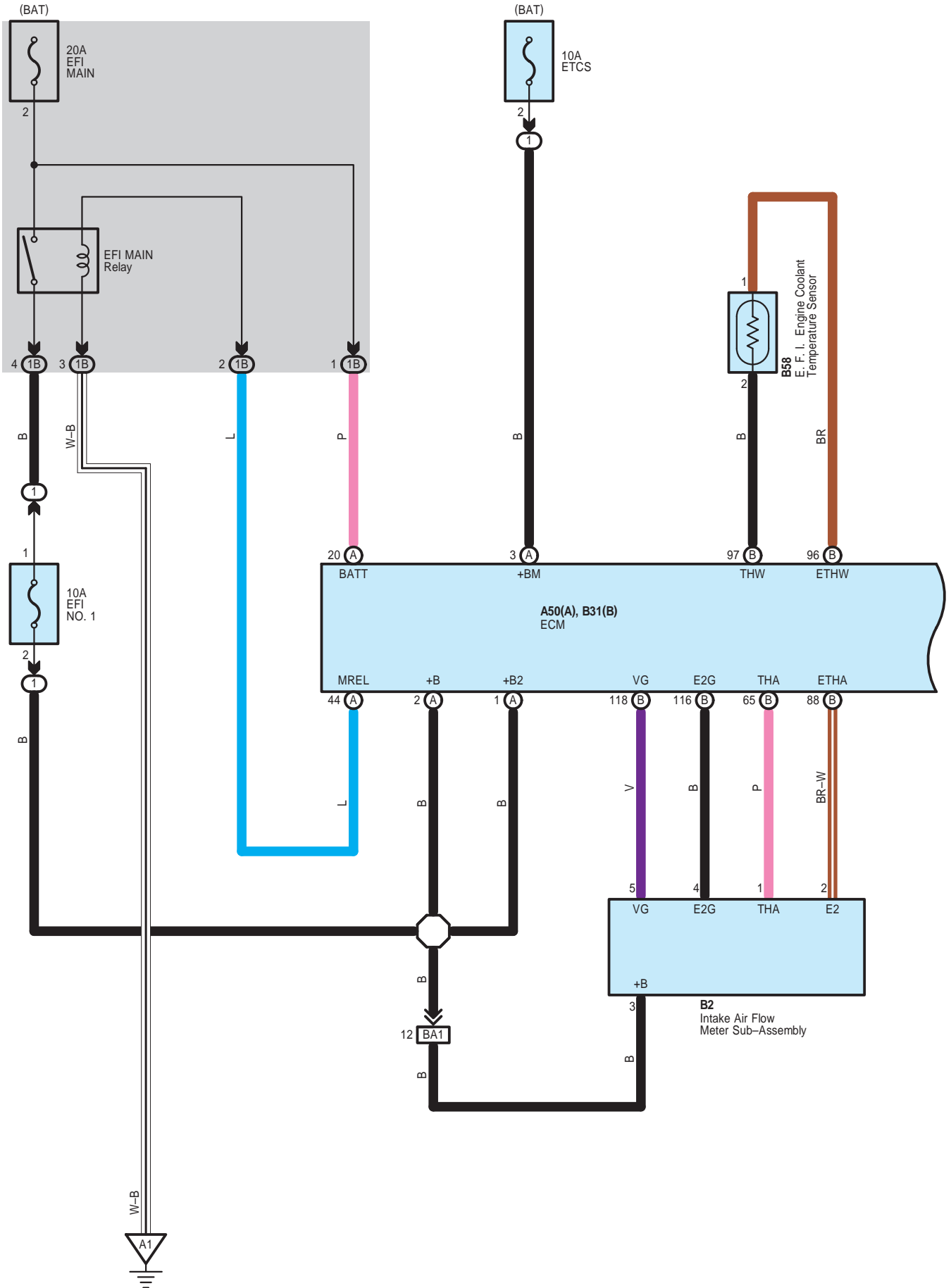

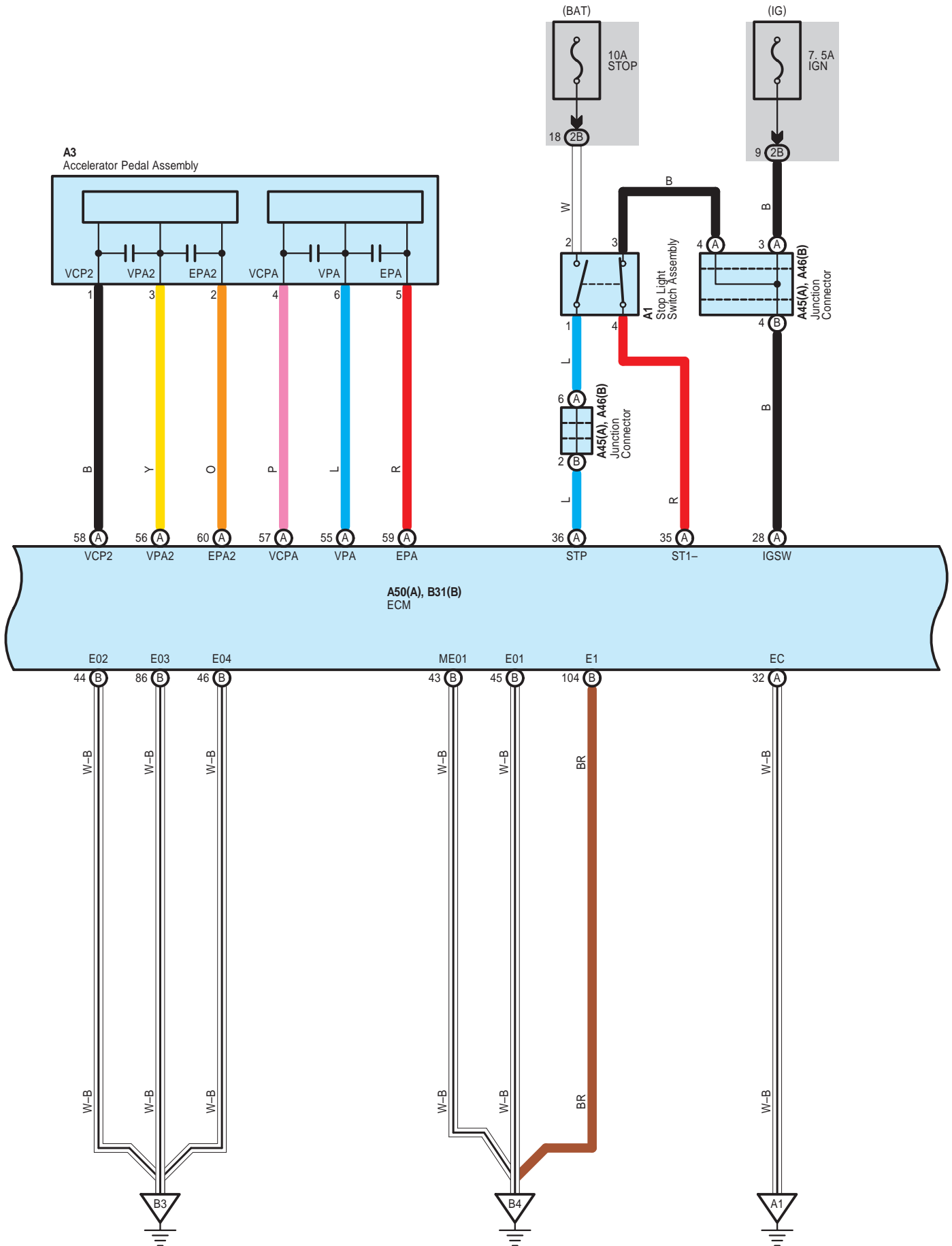



\* 1 : Shielded

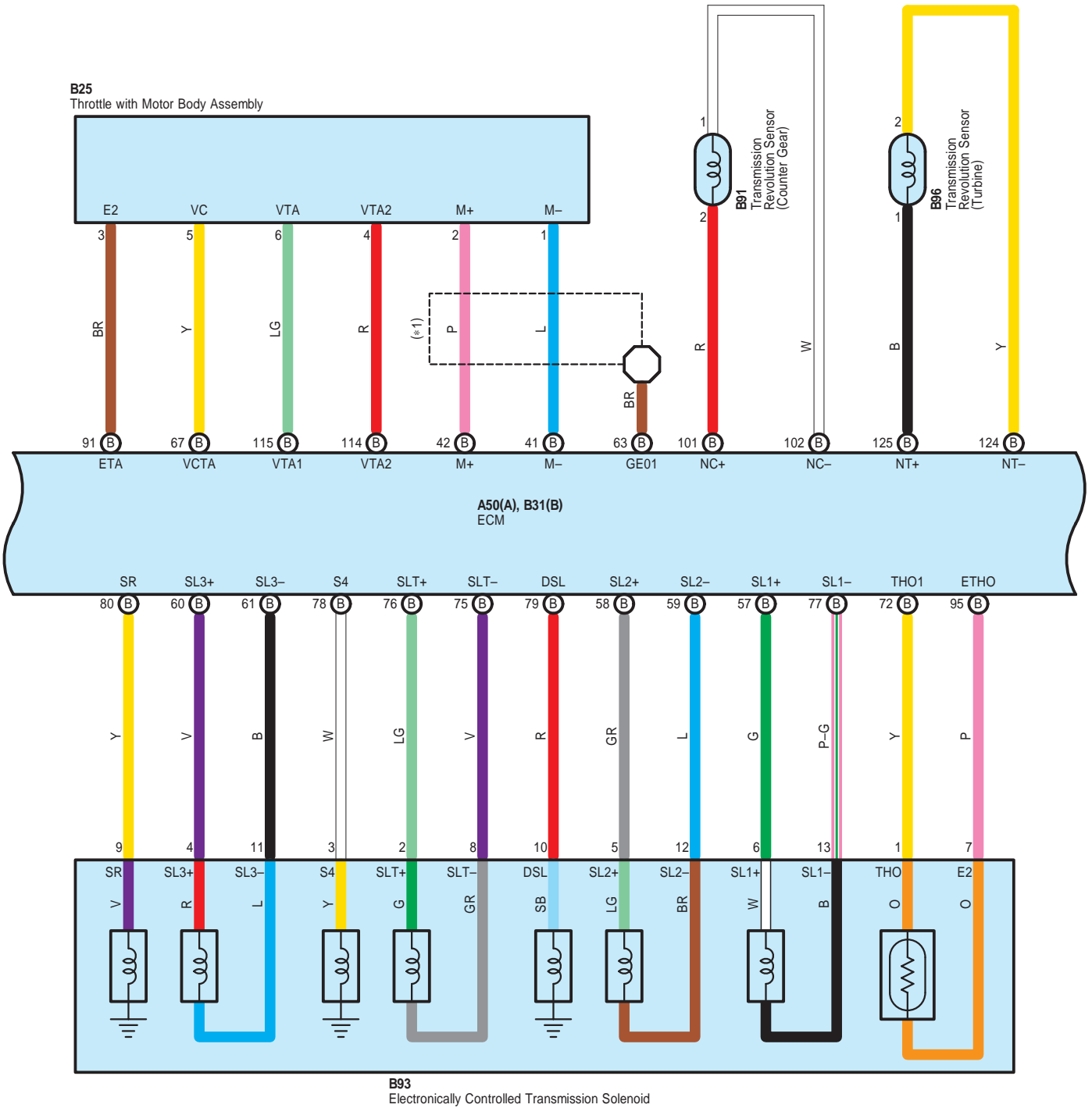

Electronically Controlled Transmission and A/T Indicator <2AZ-FE , Except TMC Made>

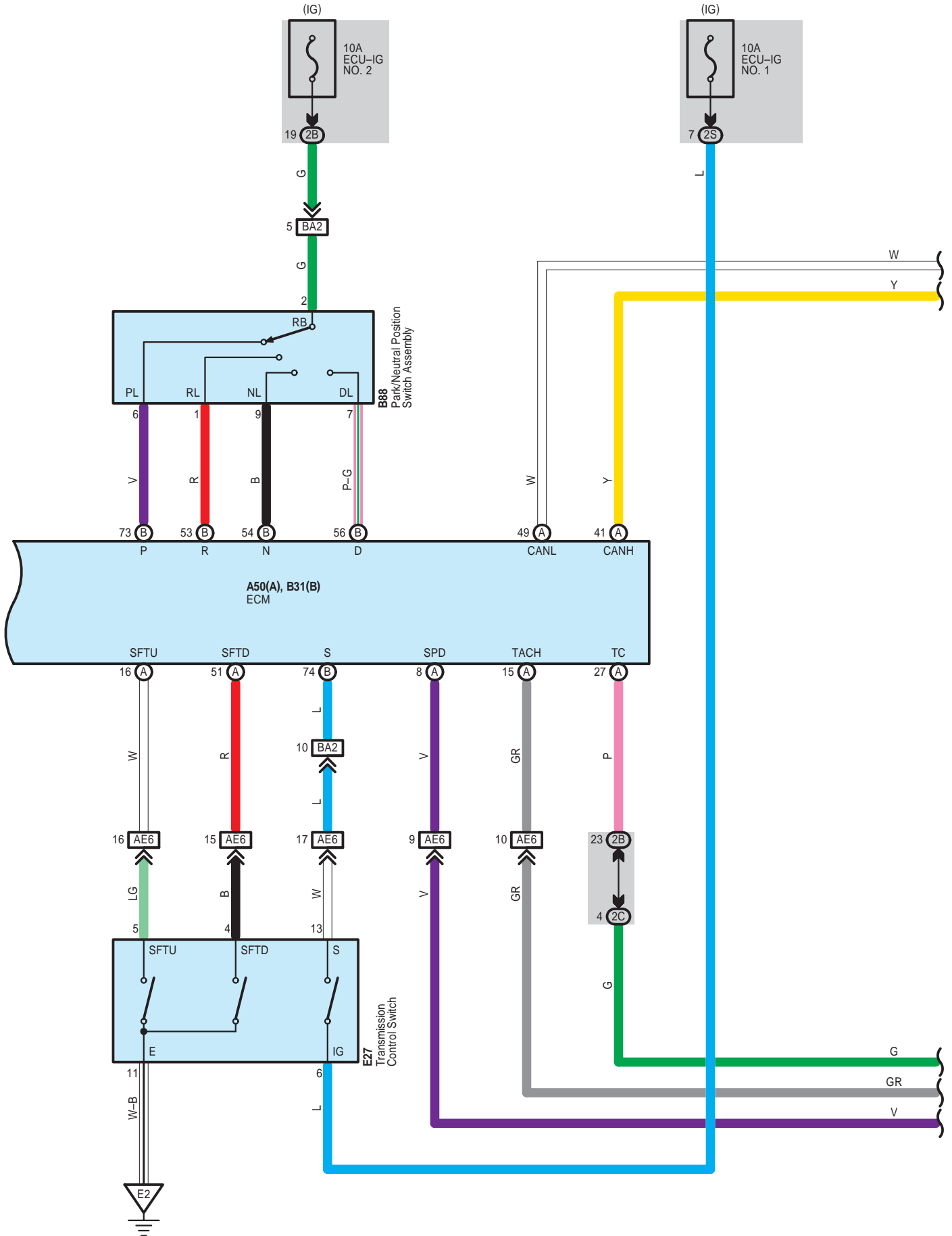

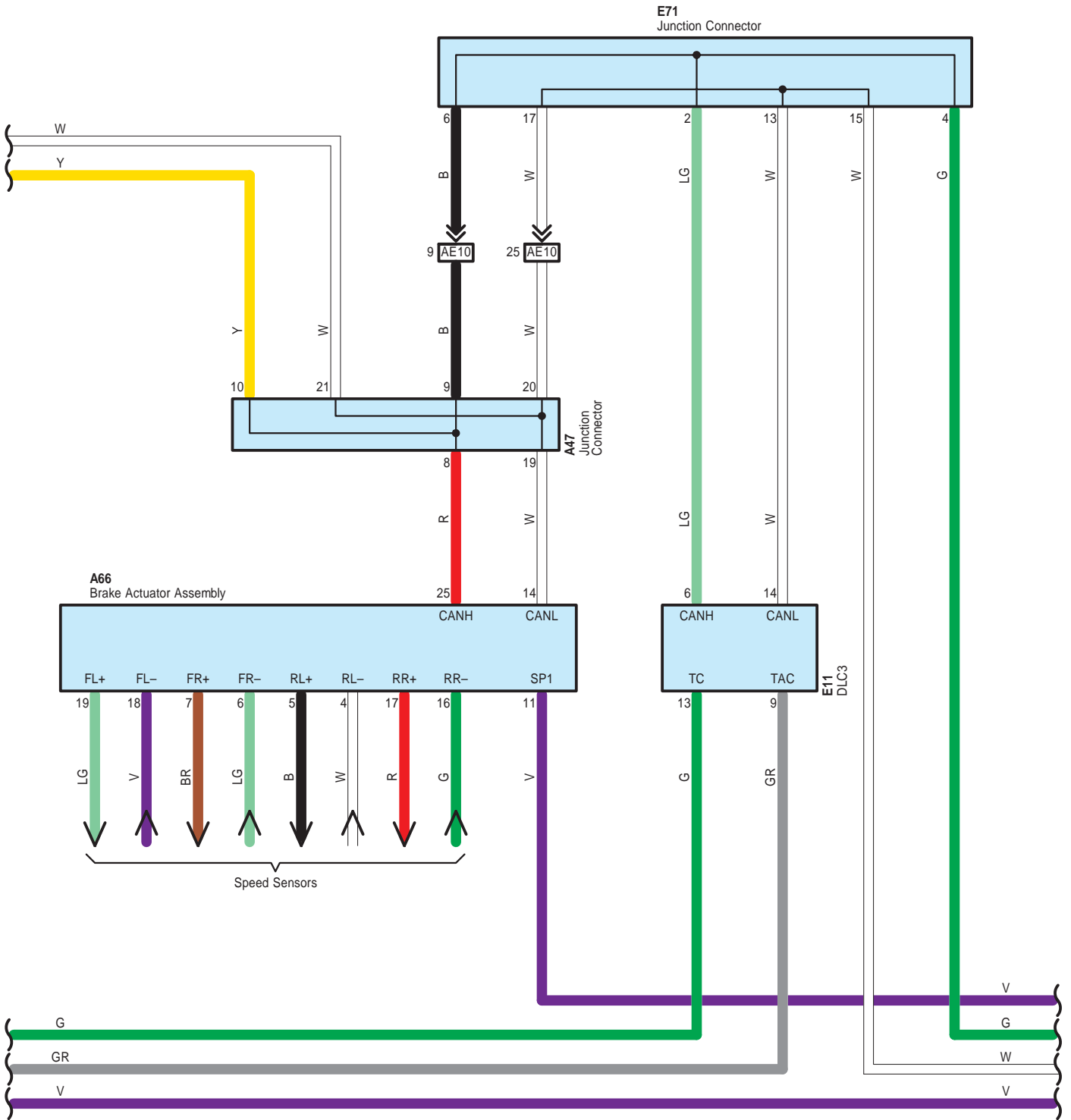

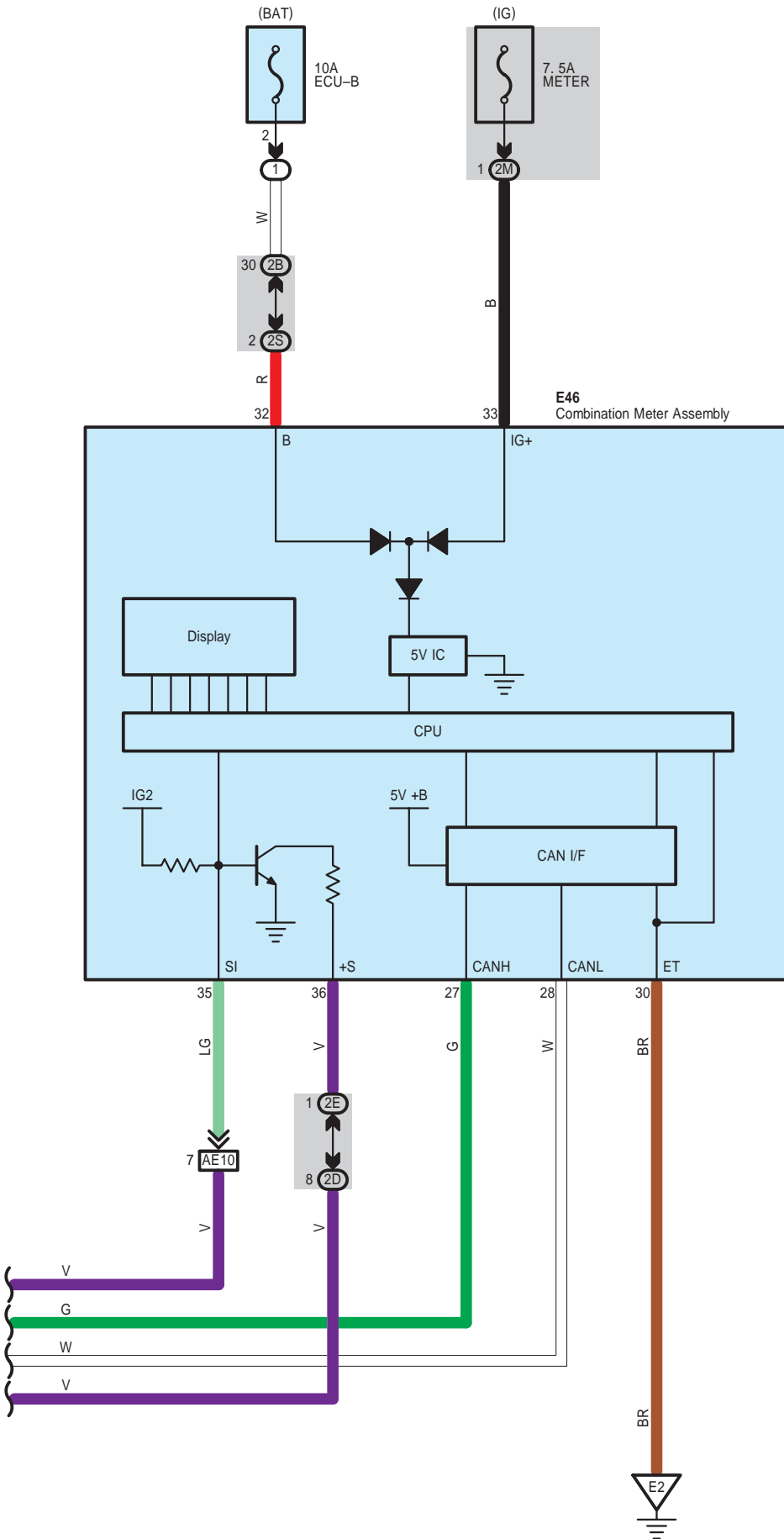

Electronically Controlled Transmission and A/T Indicator <2AZ-FE , Except TMC Made>

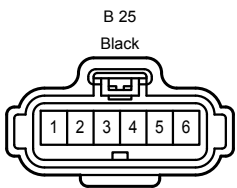
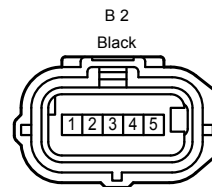
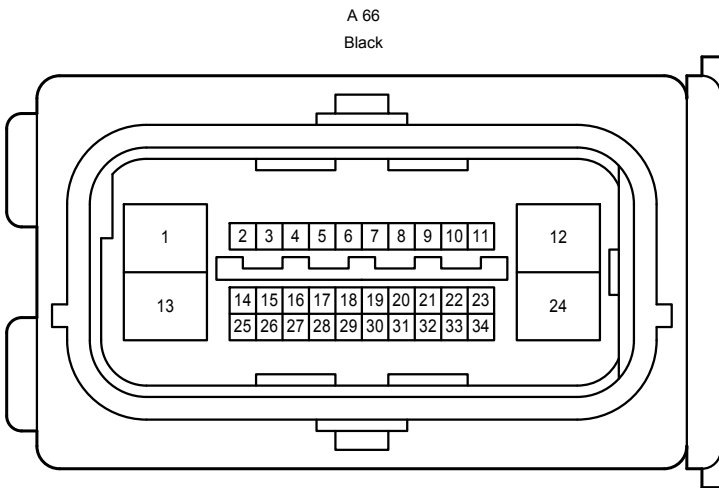
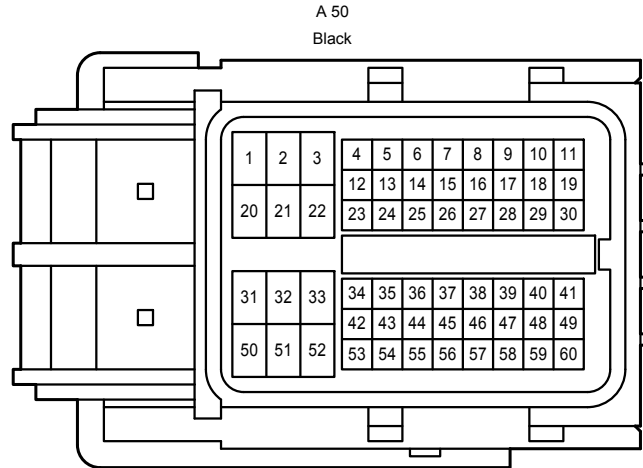
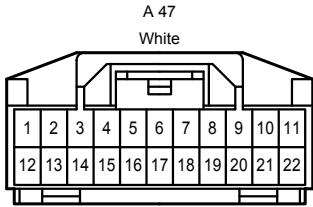
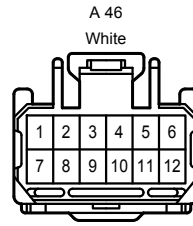
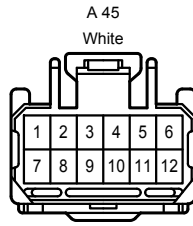
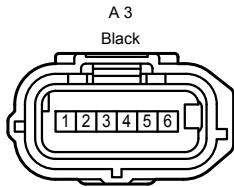
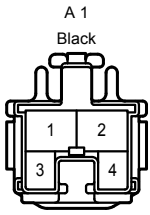

Electronically Controlled Transmission and A/T Indicator <2AZ-FE , Except TMC Made>

B 31  
Black

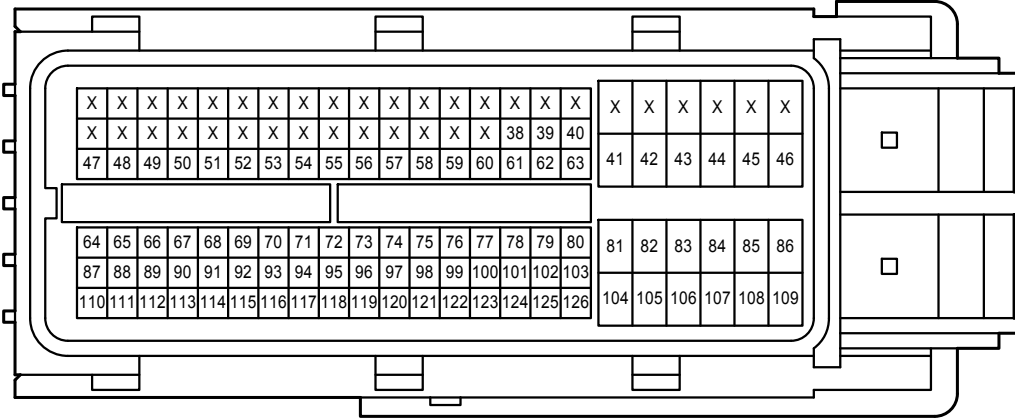

B 58  
Gray



B 88  
Gray

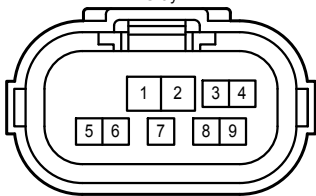

B 91  
Black

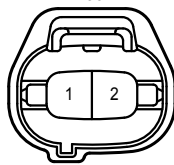

B 93  
Gray

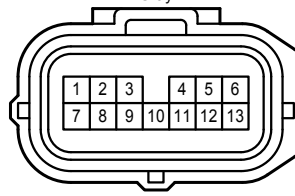

B 96  
Black

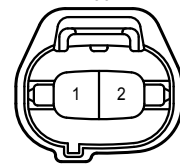

E 11  
White

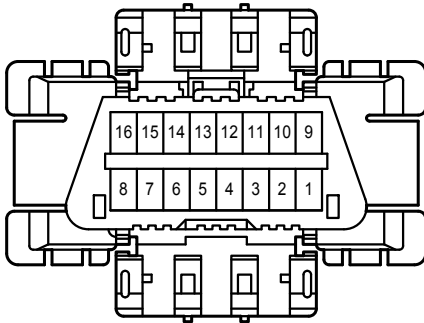

E 27  
White

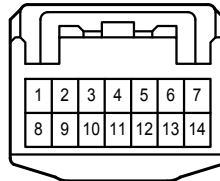

E 46  
White

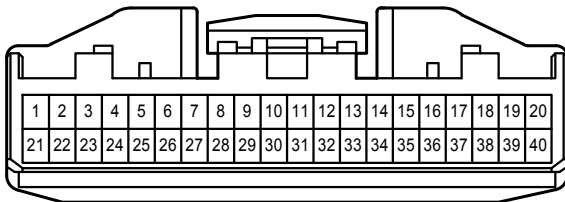

E 71  
White

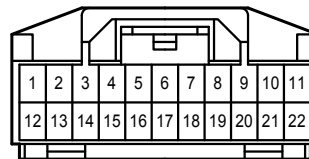

1B  
White

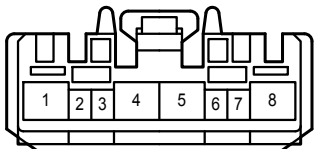

2B  
White

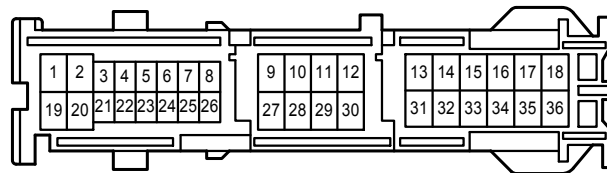

Electronically Controlled Transmission and A/T Indicator <2AZ-FE , Except TMC Made>

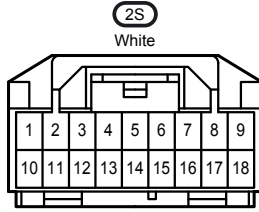
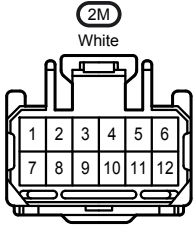
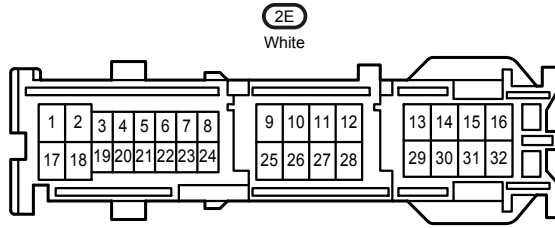
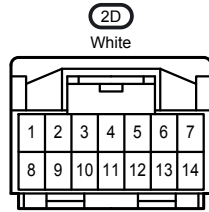
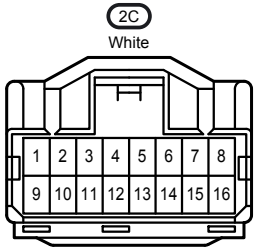

AE6  
Gray

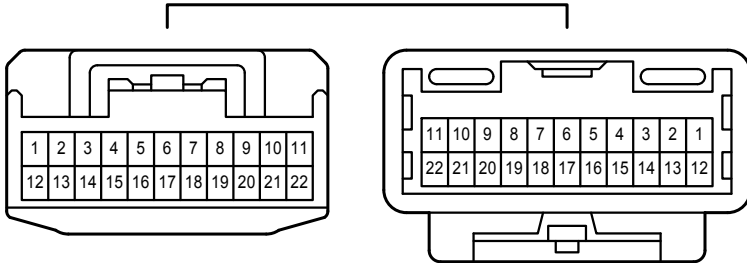

AE10  
Gray

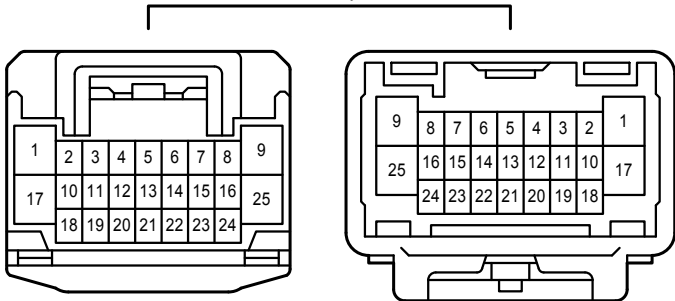

BA1  
White

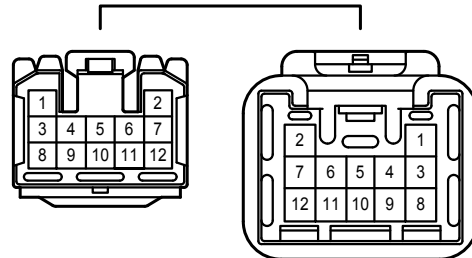

BA2  
White

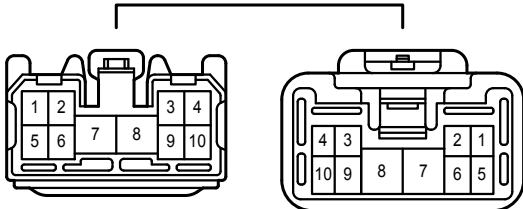

Electronically Controlled Transmission and A/T Indicator <2ZR-FE , Except TMC Made>

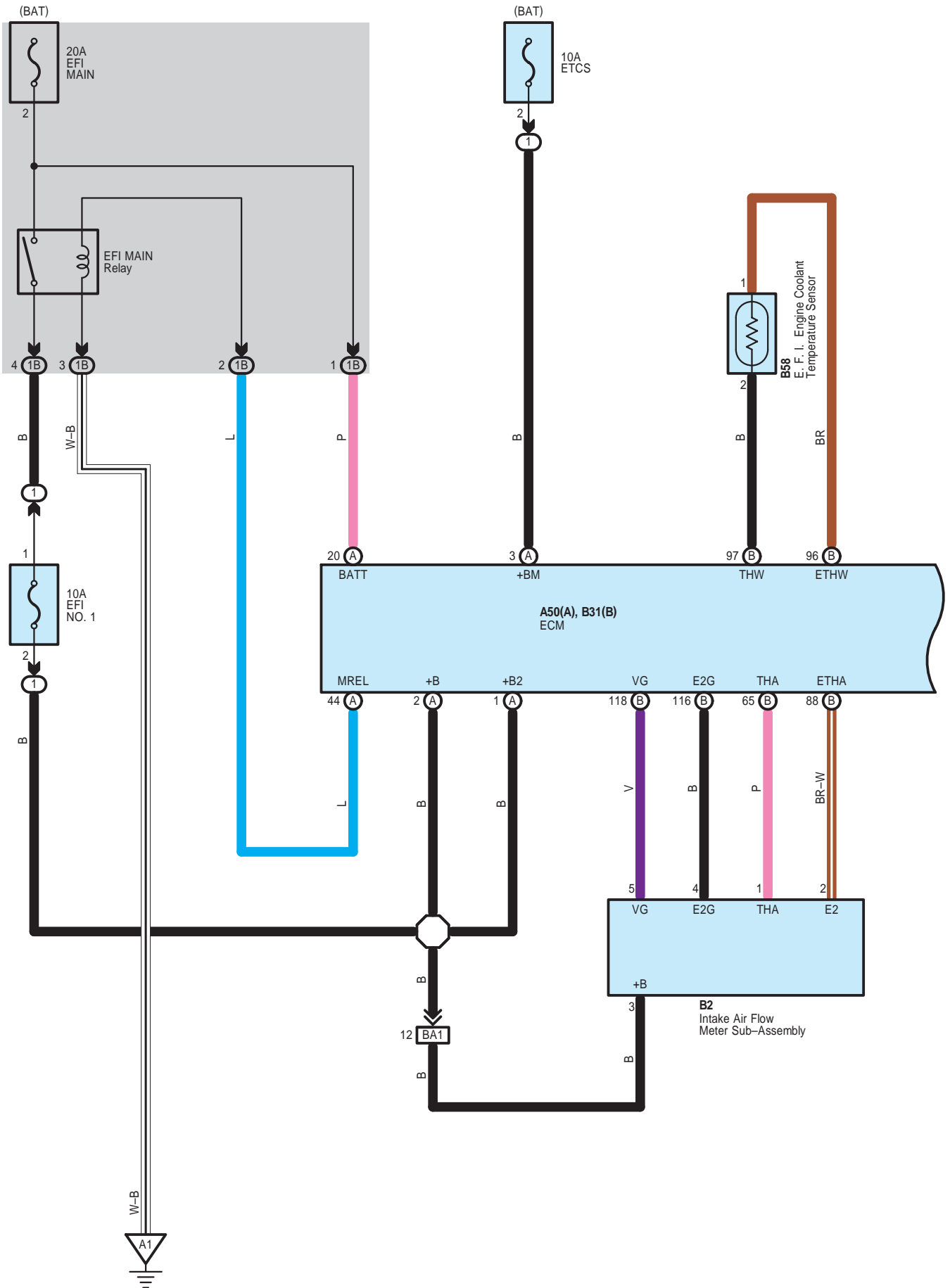



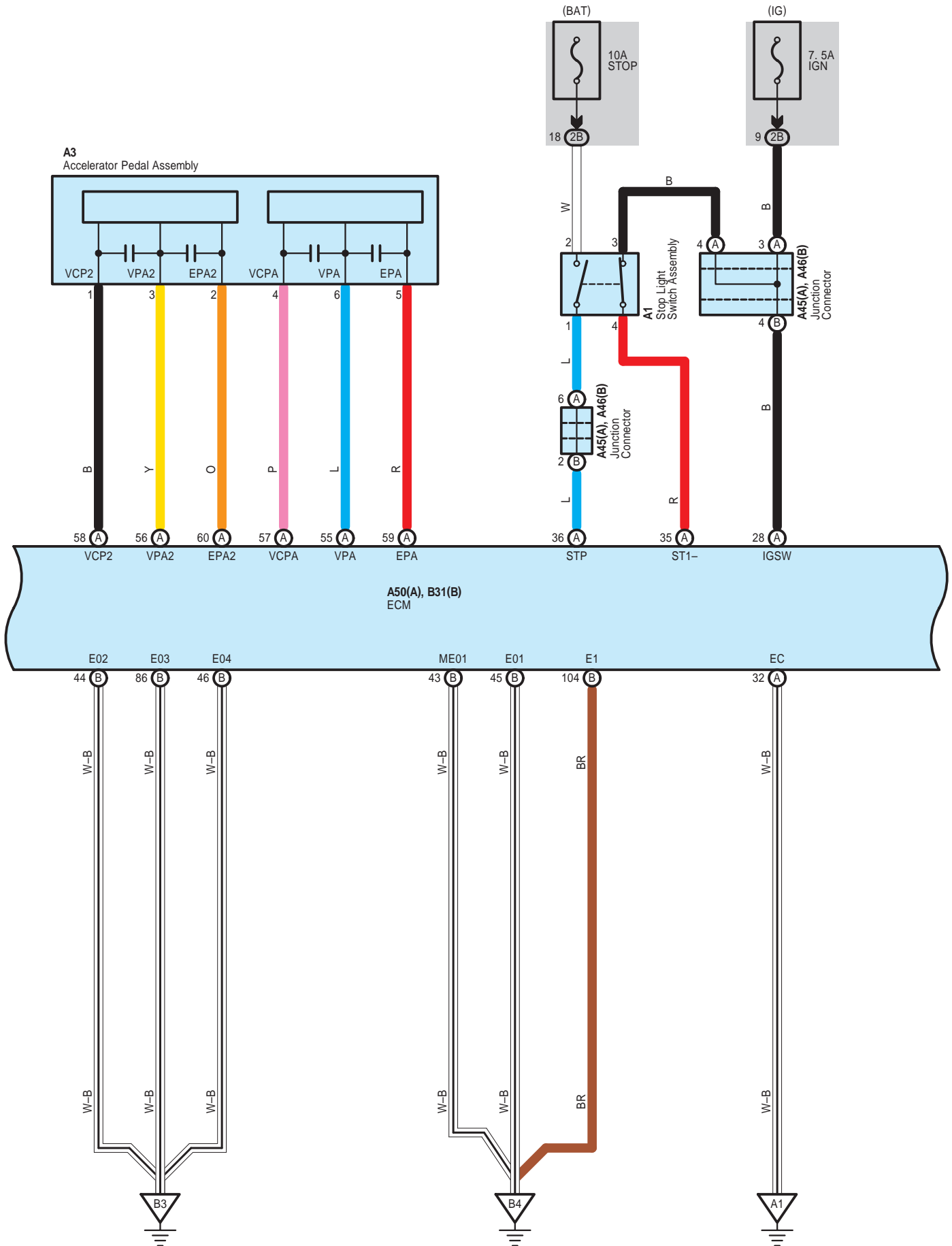

\* 1 : Shielded

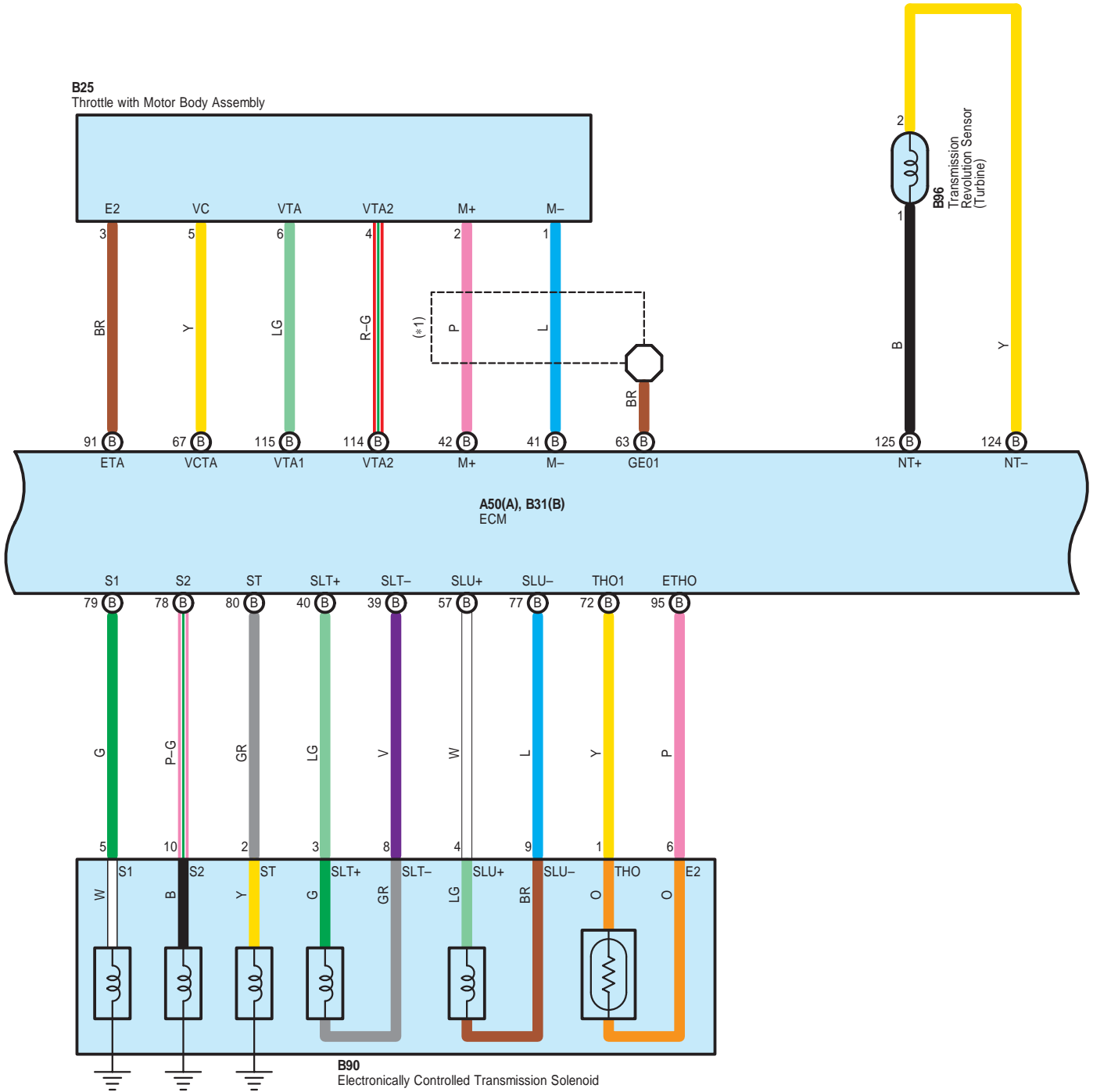

Electronically Controlled Transmission and A/T Indicator <2ZR-FE , Except TMC Made>

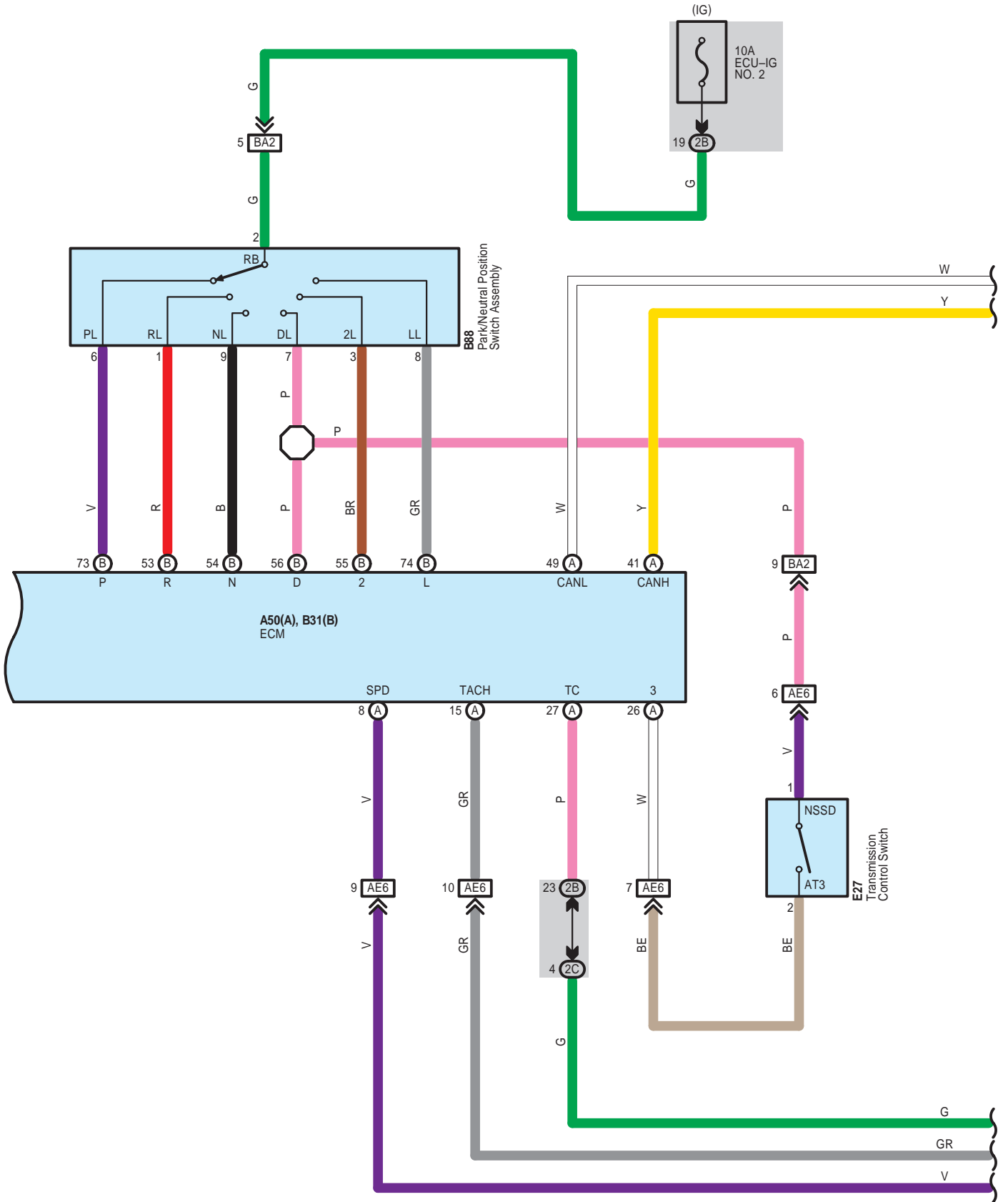

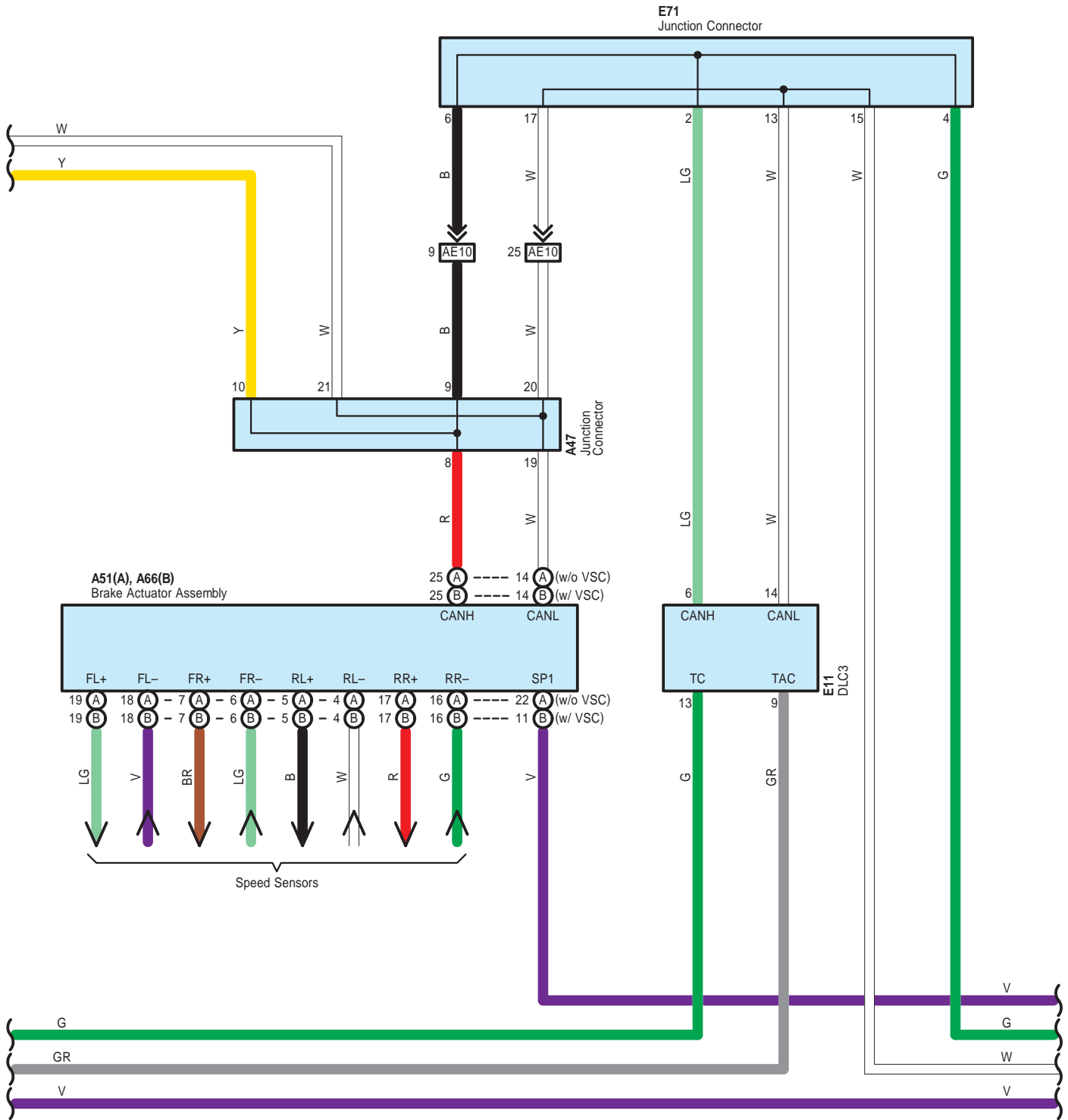

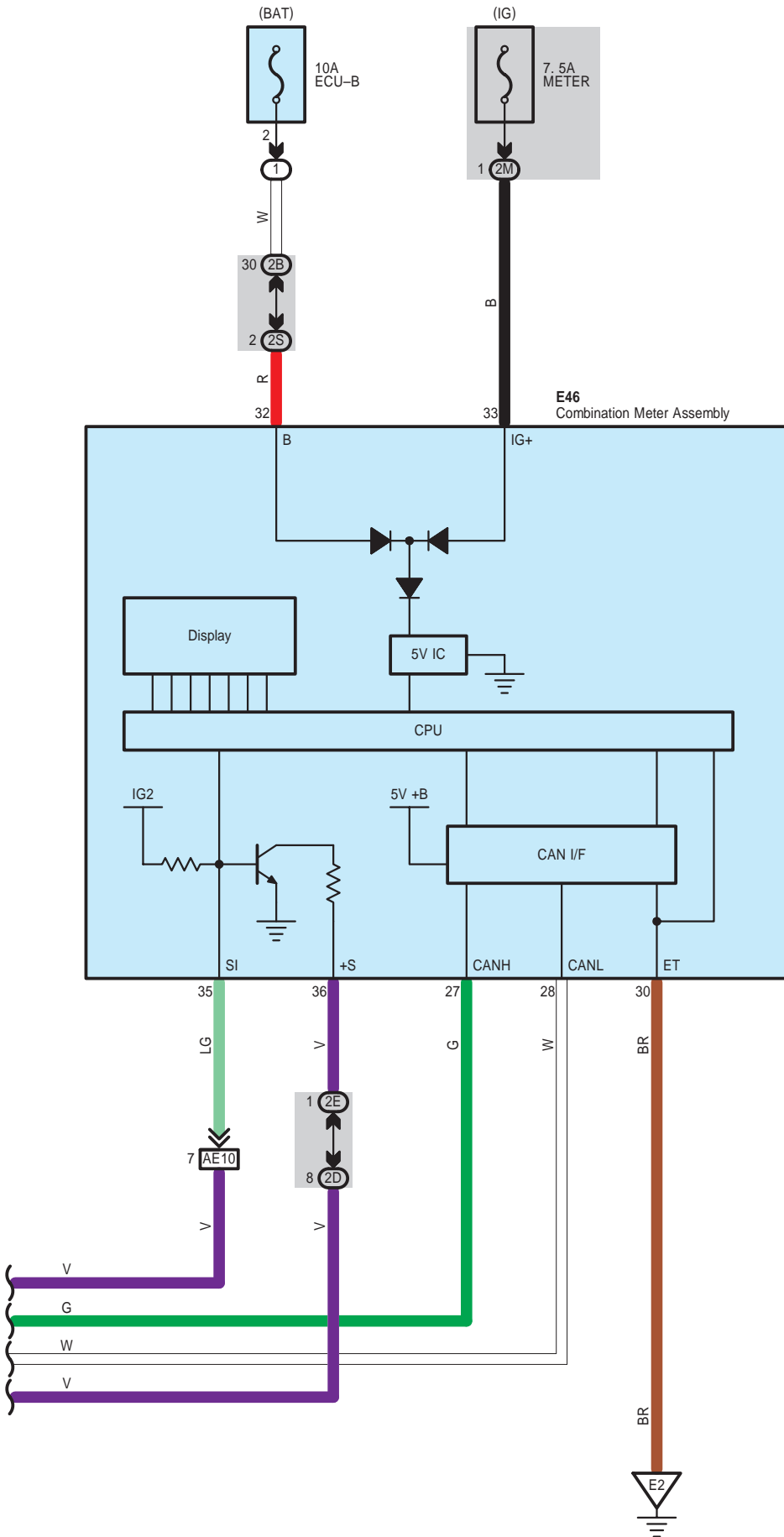

Electronically Controlled Transmission and A/T Indicator <2ZR-FE , Except TMC Made>

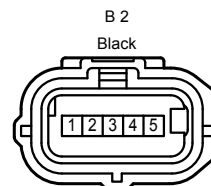
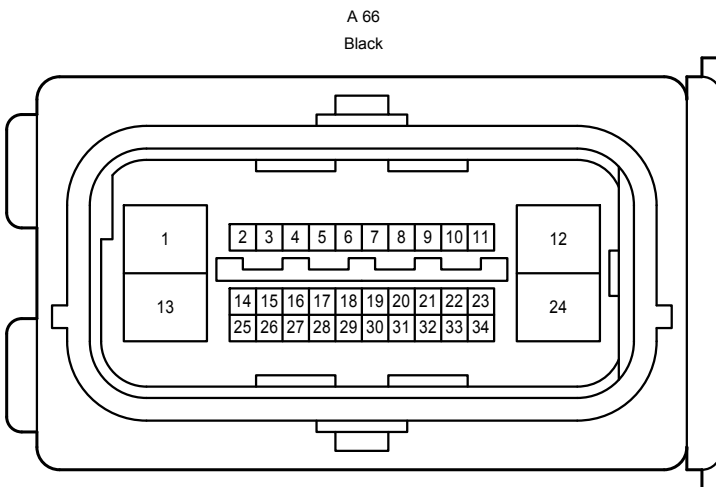
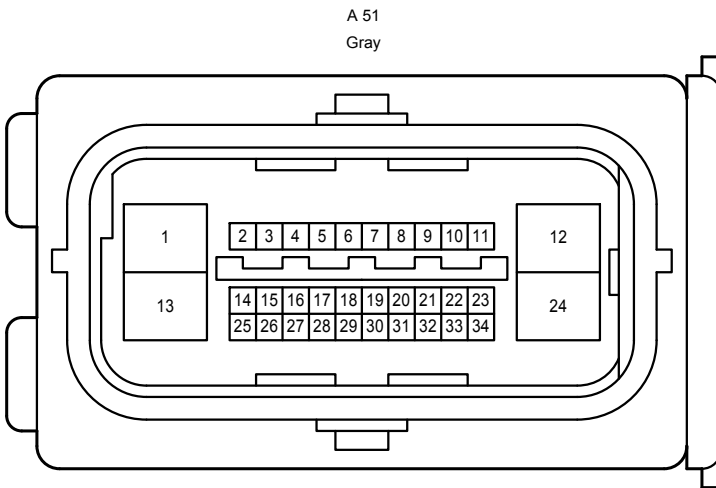
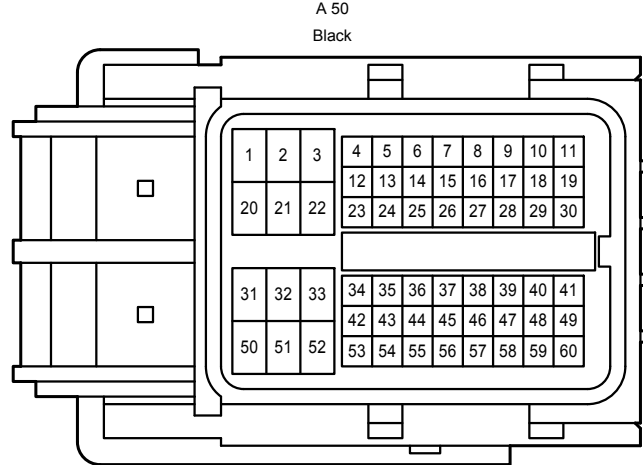
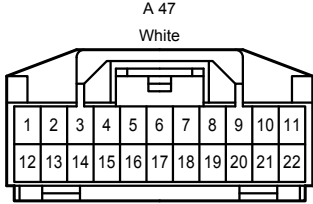
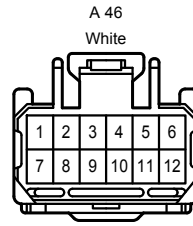
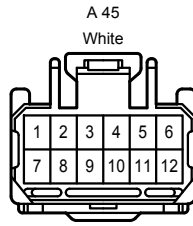
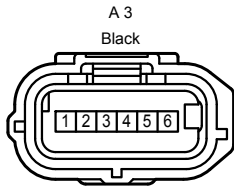
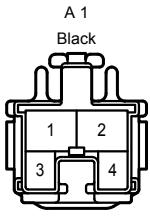



Electronically Controlled Transmission and A/T Indicator <2ZR-FE , Except TMC Made>

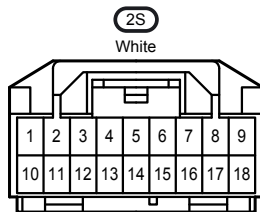
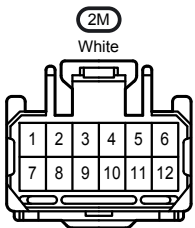
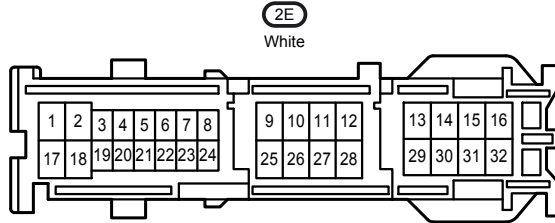
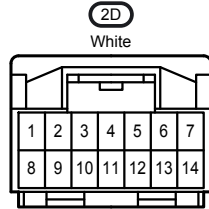
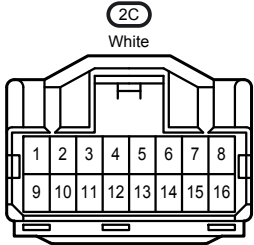
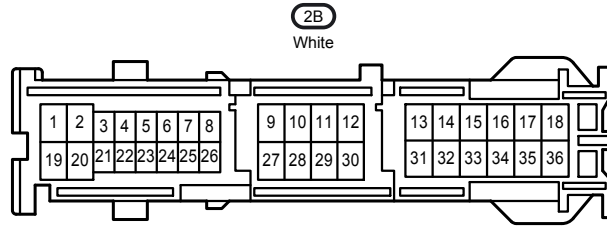
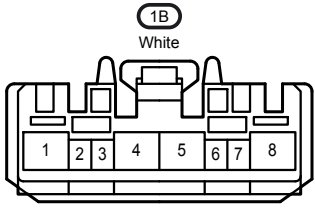

AE6  
Gray

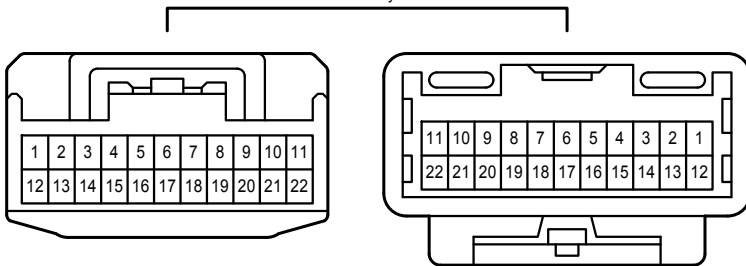

AE10  
Gray

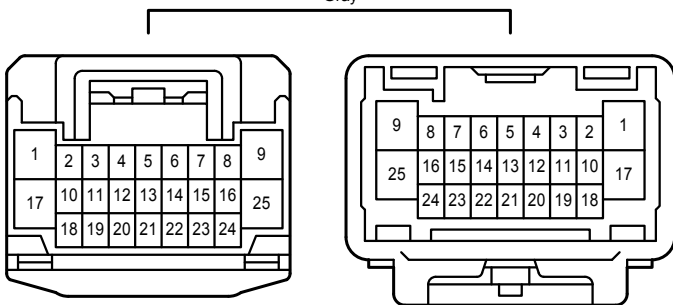

BA1  
White

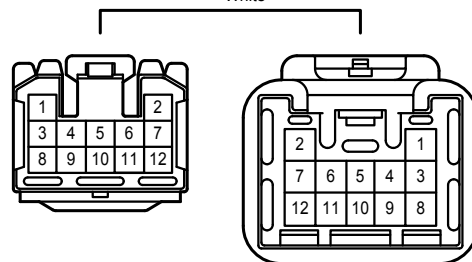

BA2  
White

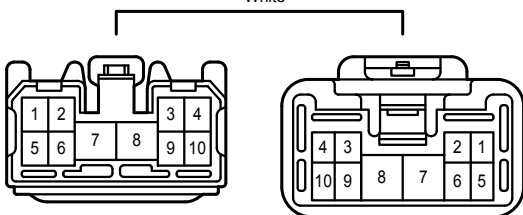



Electronically Controlled Transmission and A/T Indicator <TMC Made>

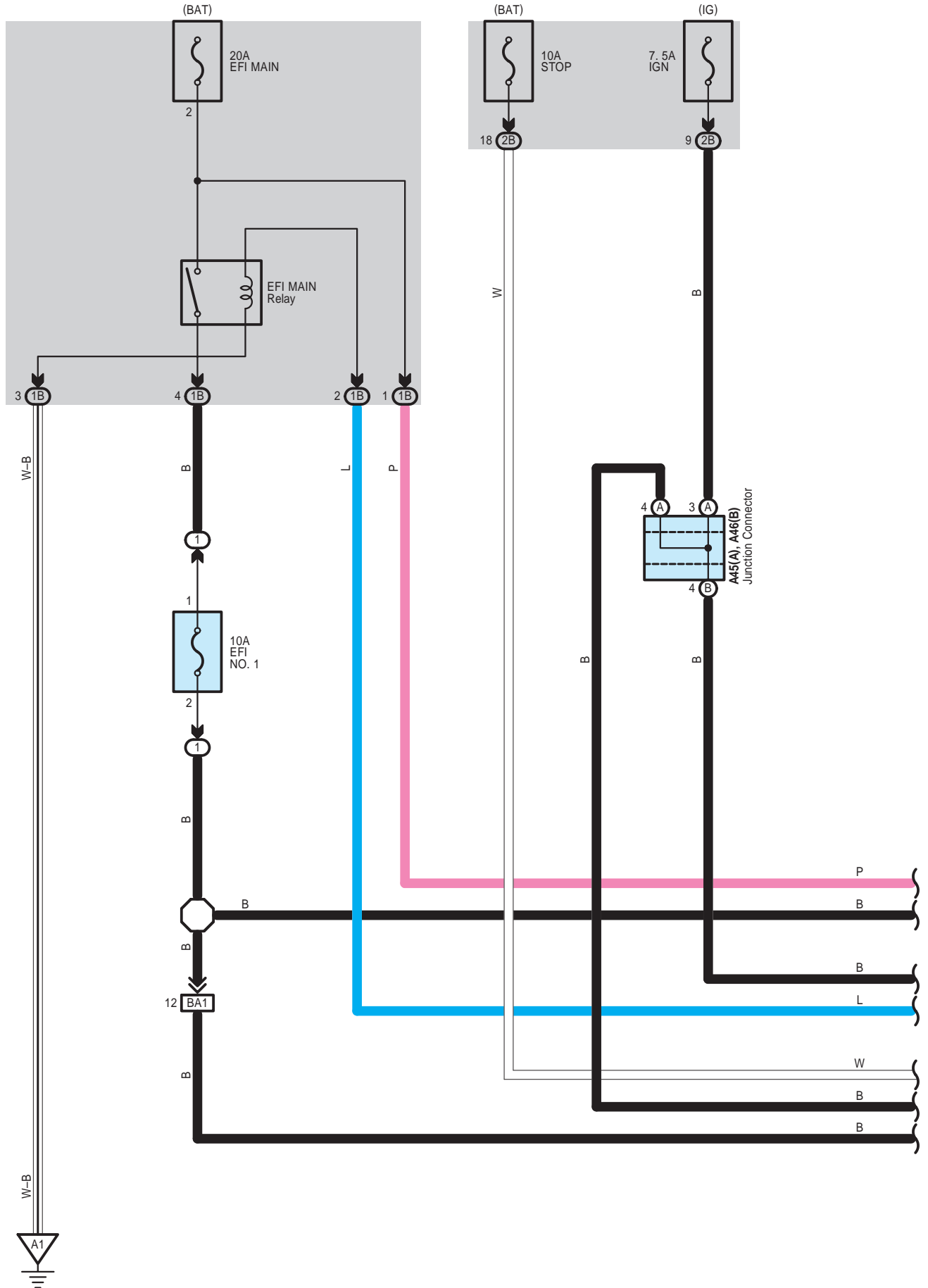

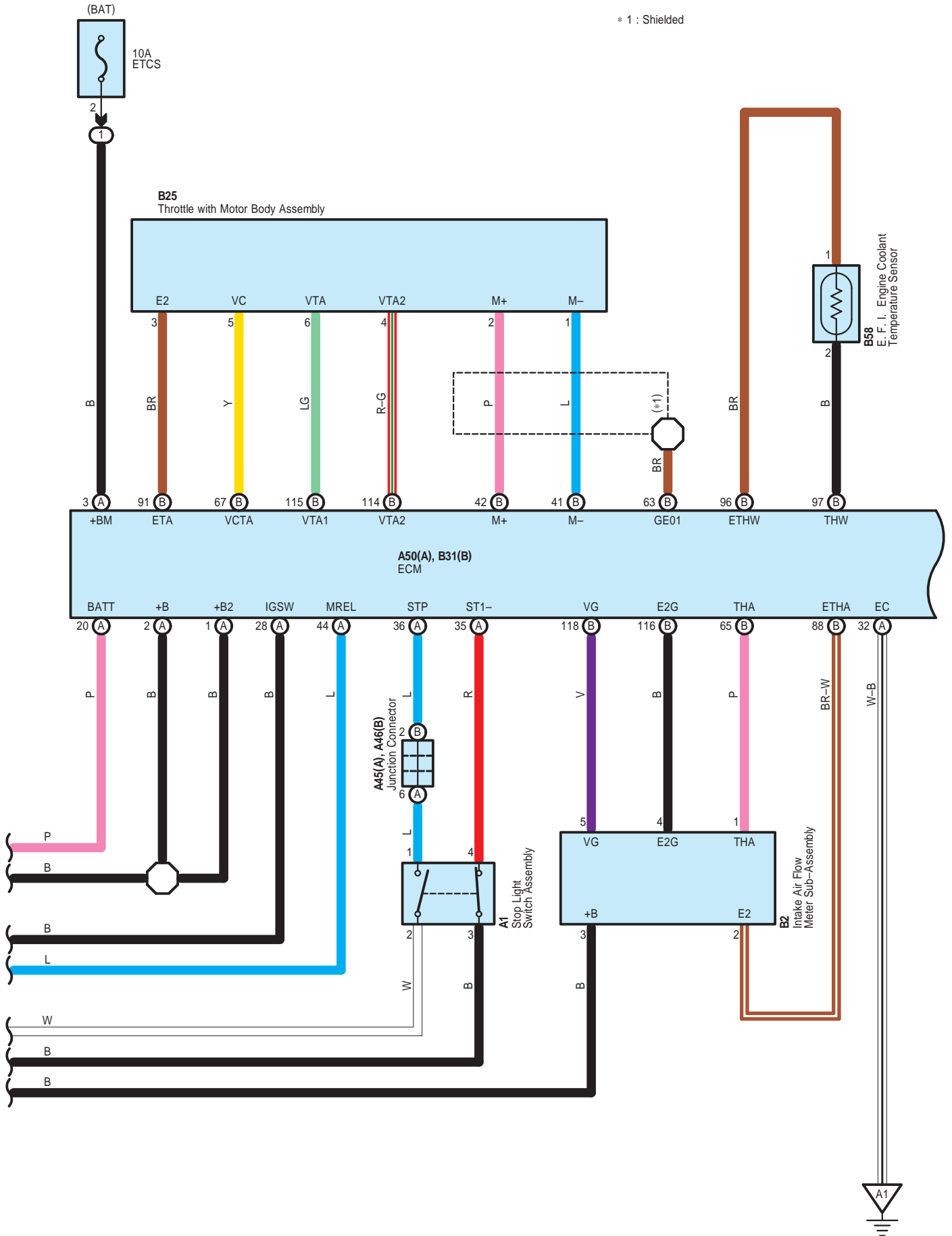

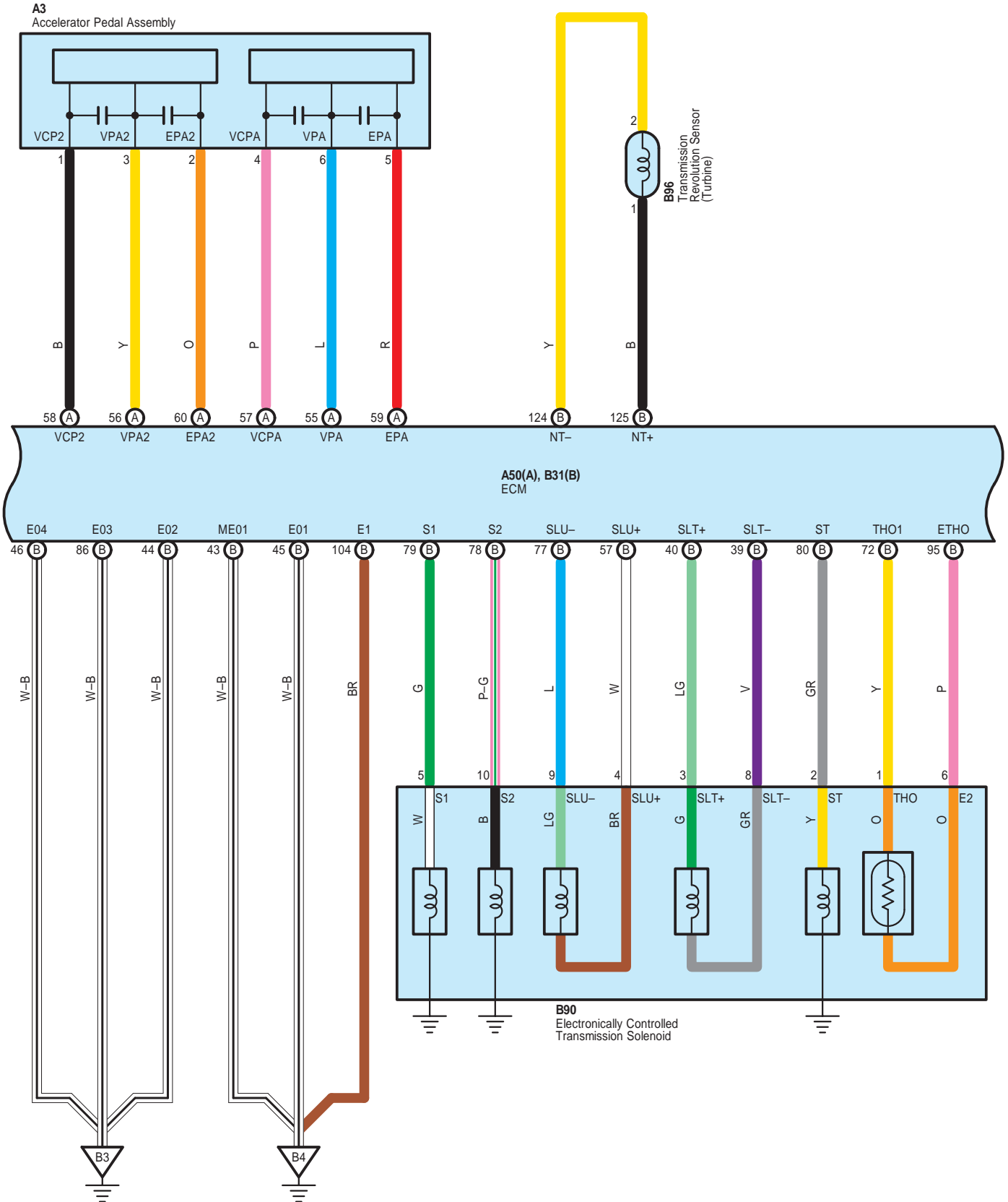

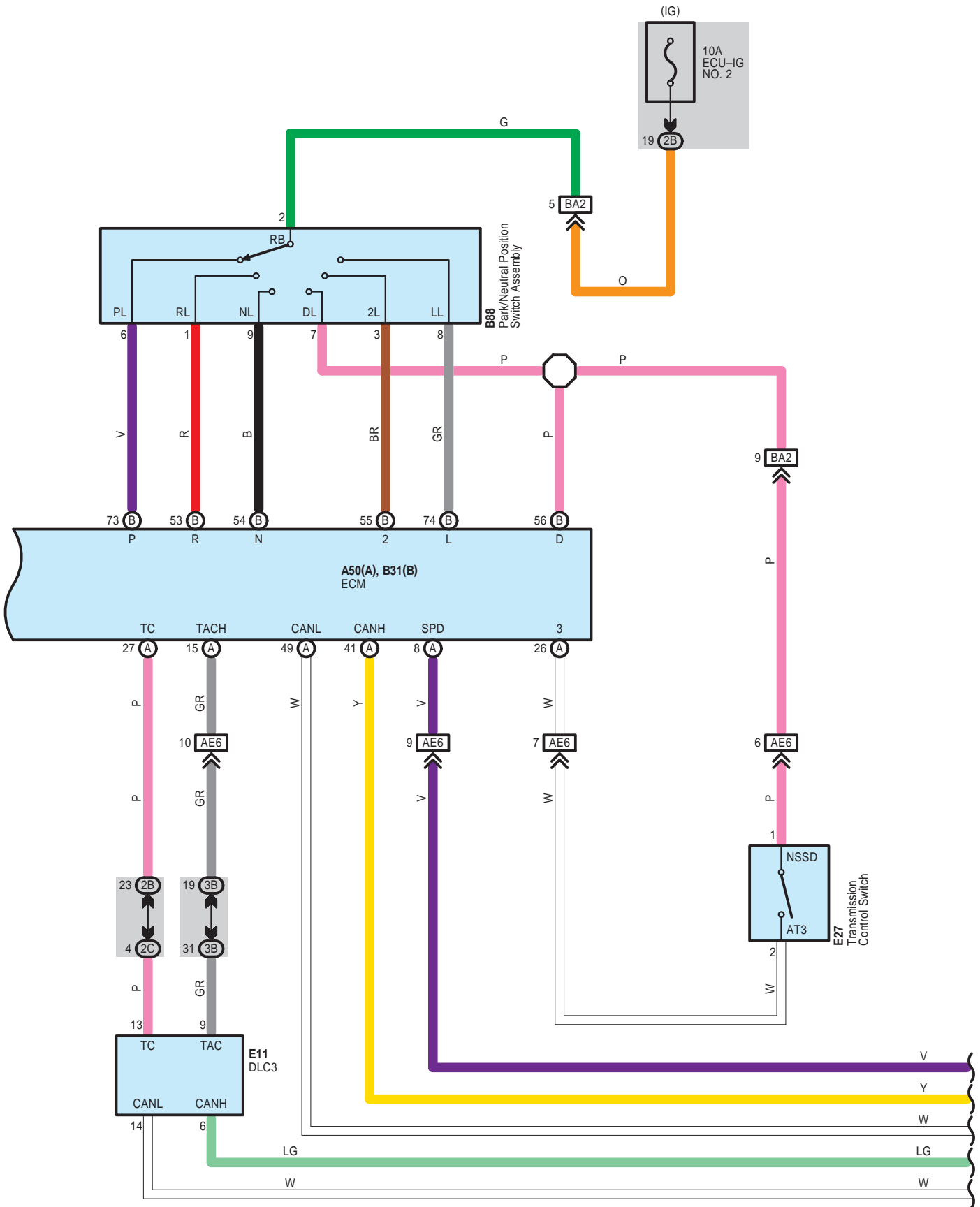

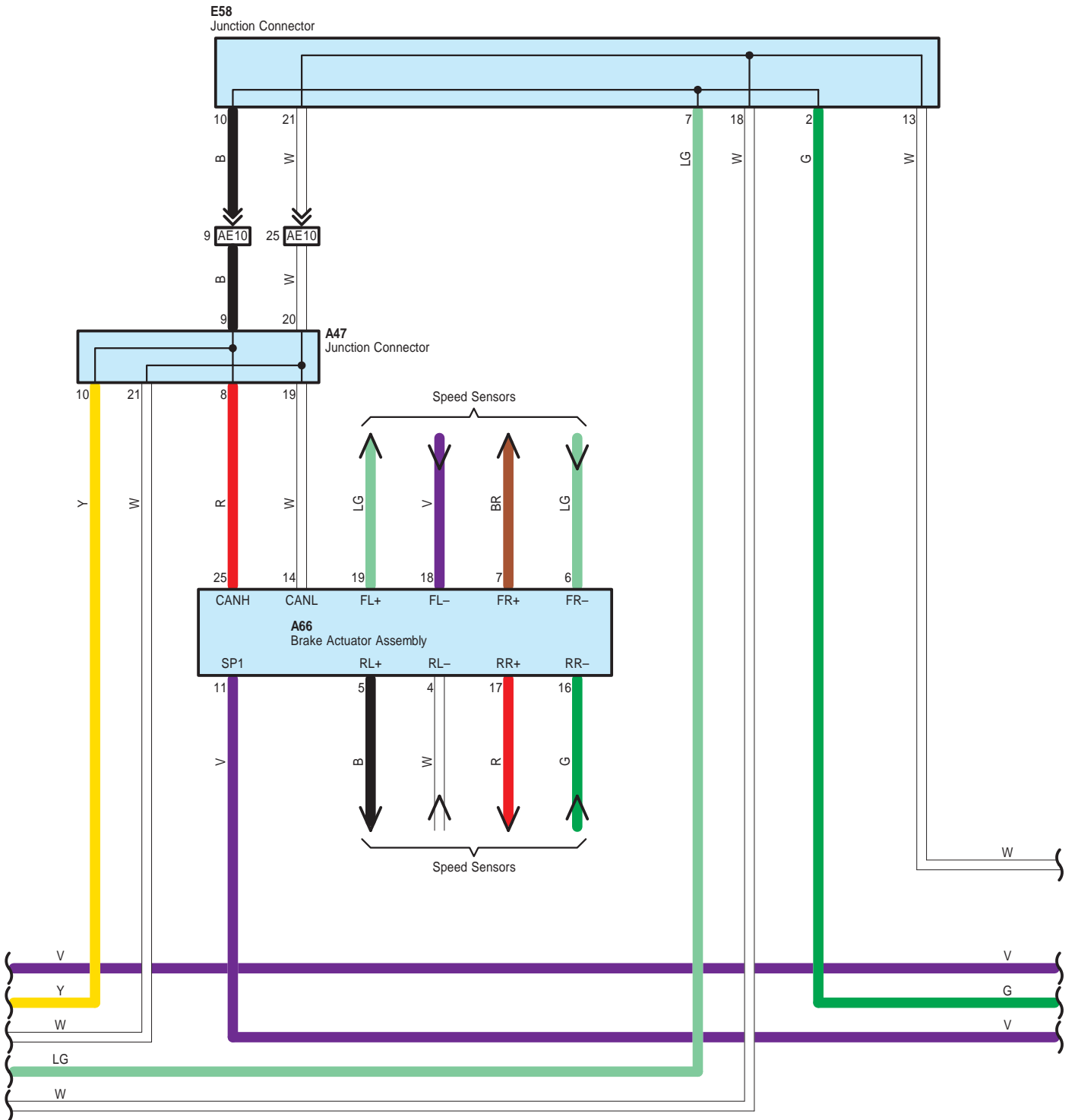

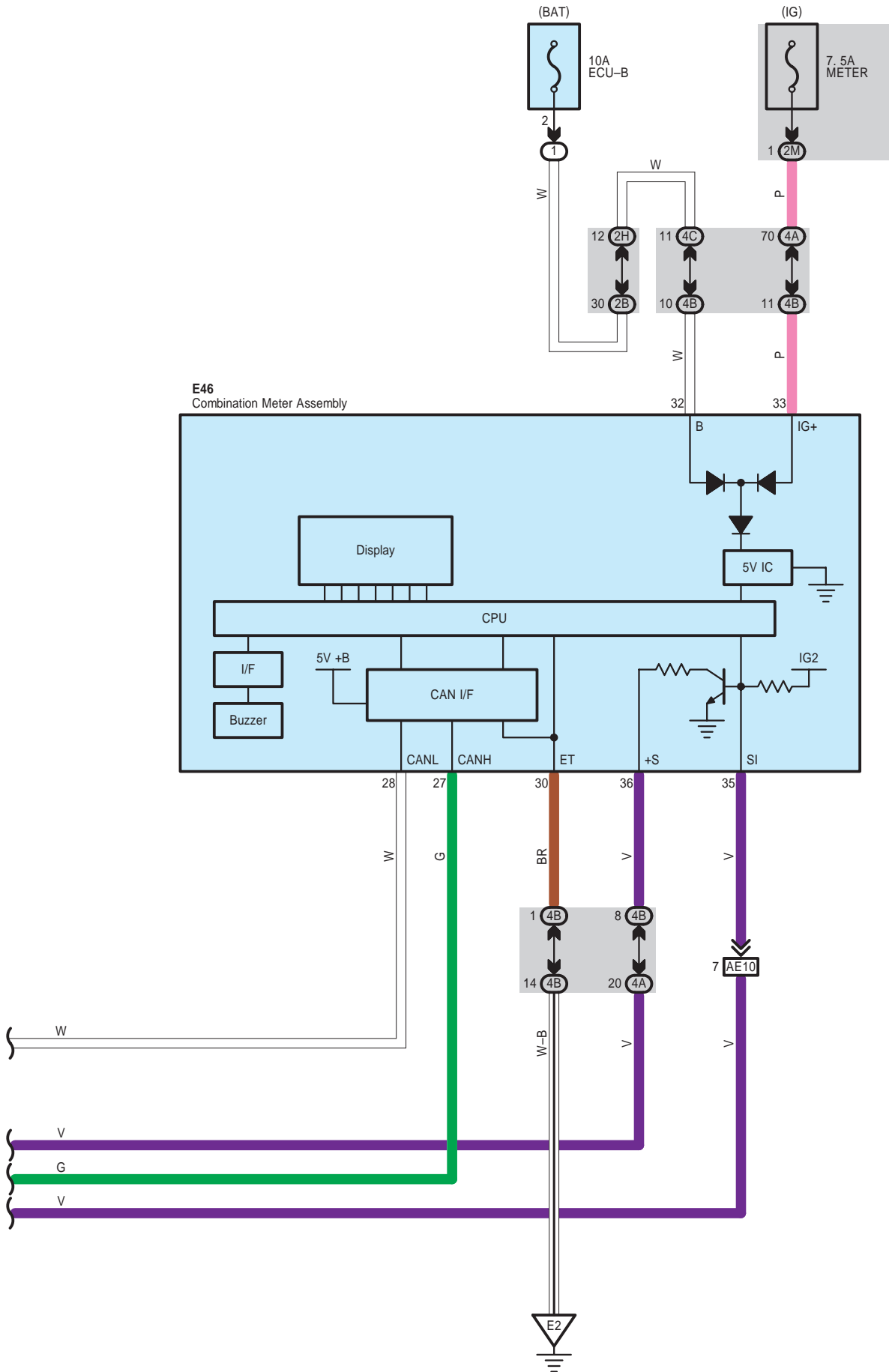

Electronically Controlled Transmission and A/T Indicator <TMC Made>

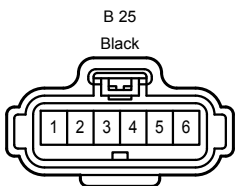
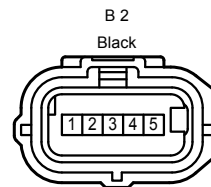
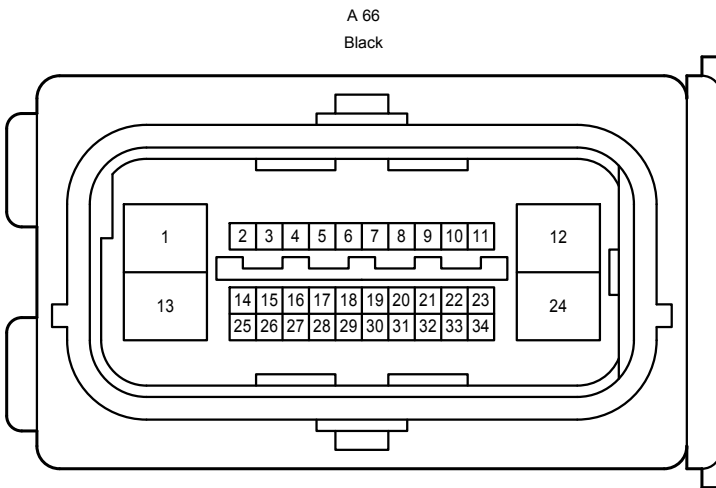
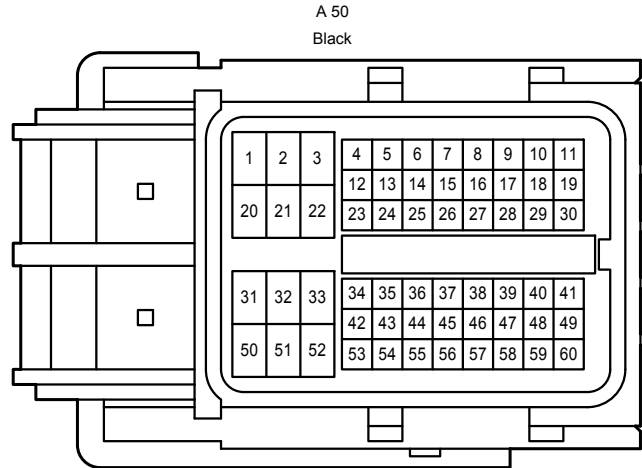
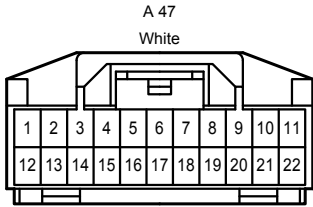
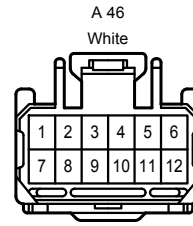
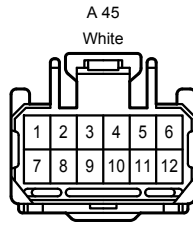
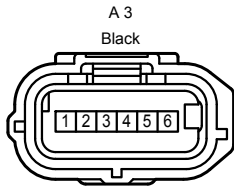
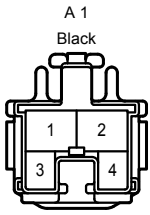

Electronically Controlled Transmission and A/T Indicator <TMC Made>

B 31  
Black

B 58  
Gray

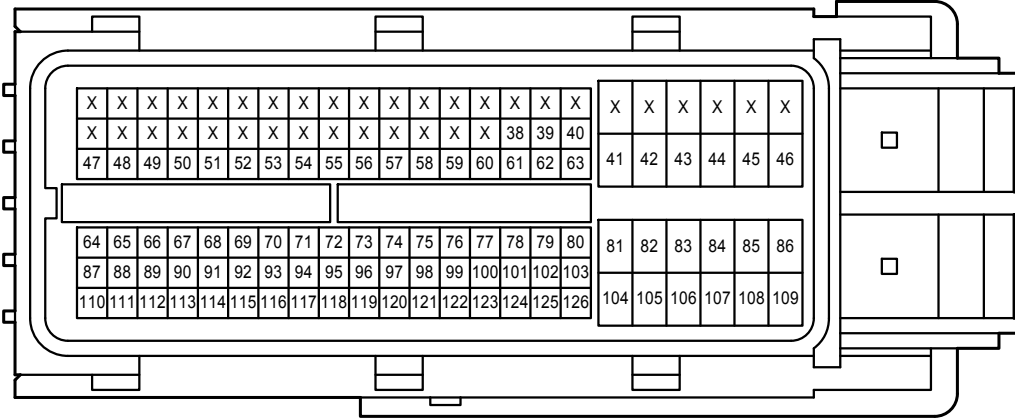

B 88  
Gray

B 90  
Gray

B 96  
Black

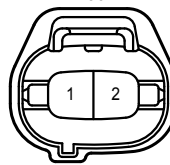
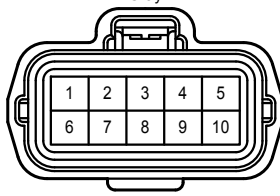
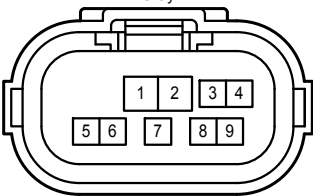

E 11  
White

E 27  
White

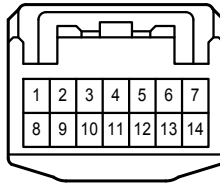
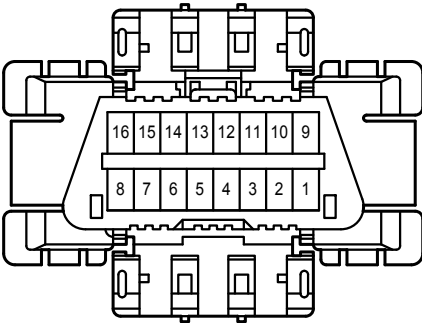

E 46  
White

E 58  
Gray

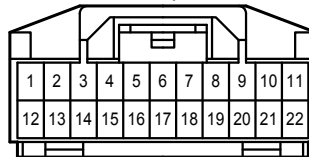
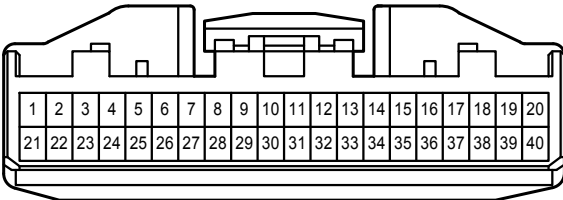

1B  
White

2B  
White

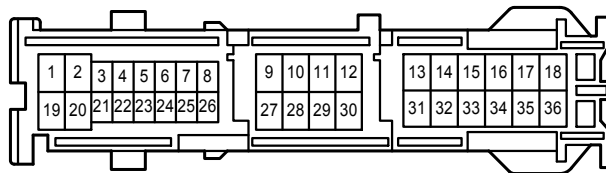
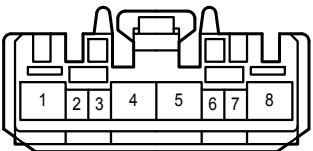



2C

White

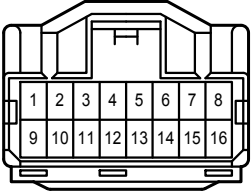

2H

White

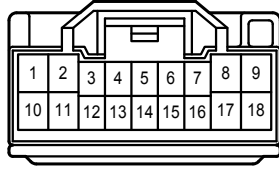

2M

White

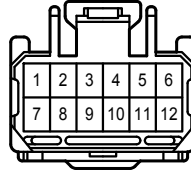

3B

White

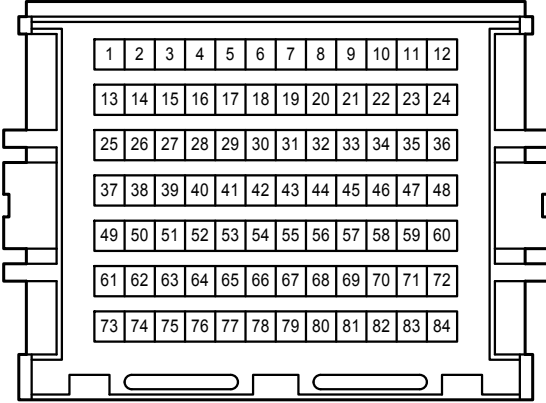

4A

White

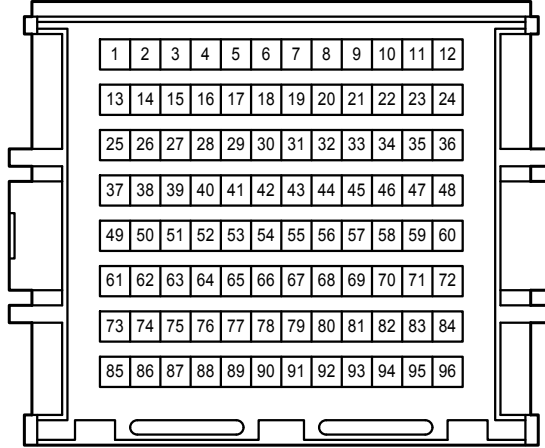

4B

White

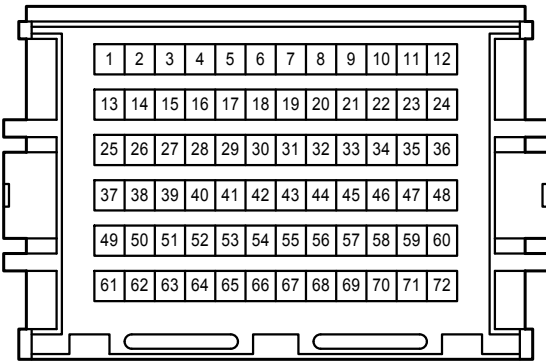

4C

White

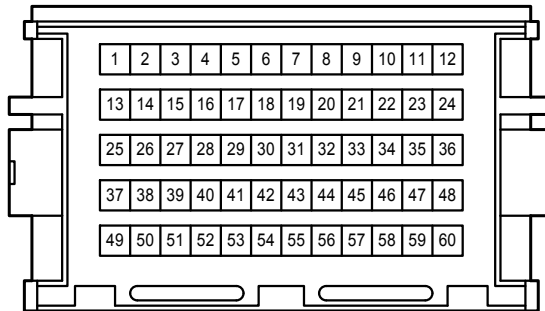

AE6

Gray

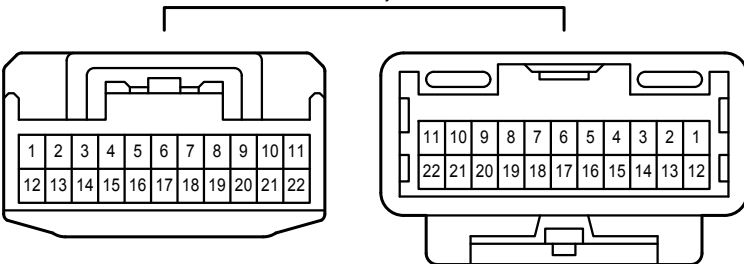

Electronically Controlled Transmission and A/T Indicator <TMC Made>

AE10  
Gray

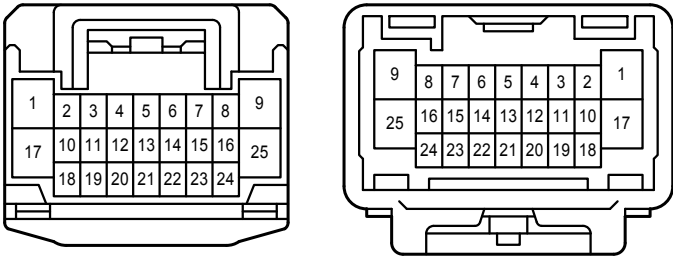

BA1  
White

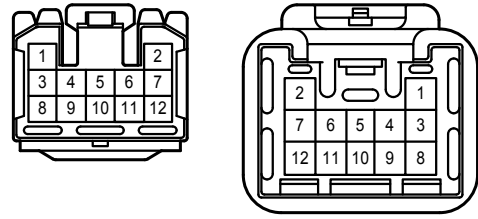

BA2  
White

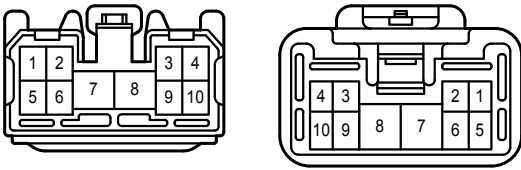

Engine Control <2AZ-FE , Except TMC Made>

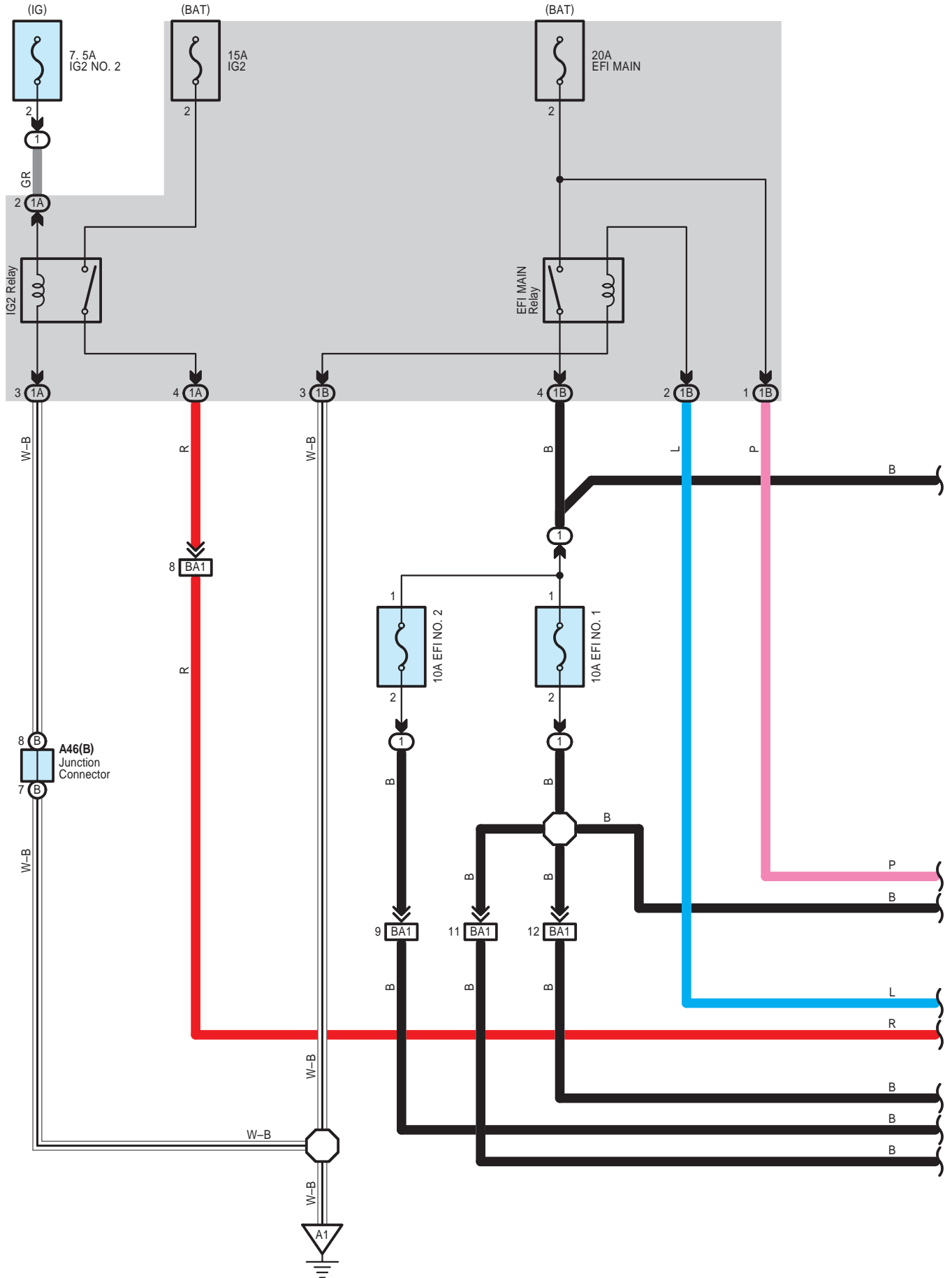

Engine Control <2AZ-FE , Except TMC Made>

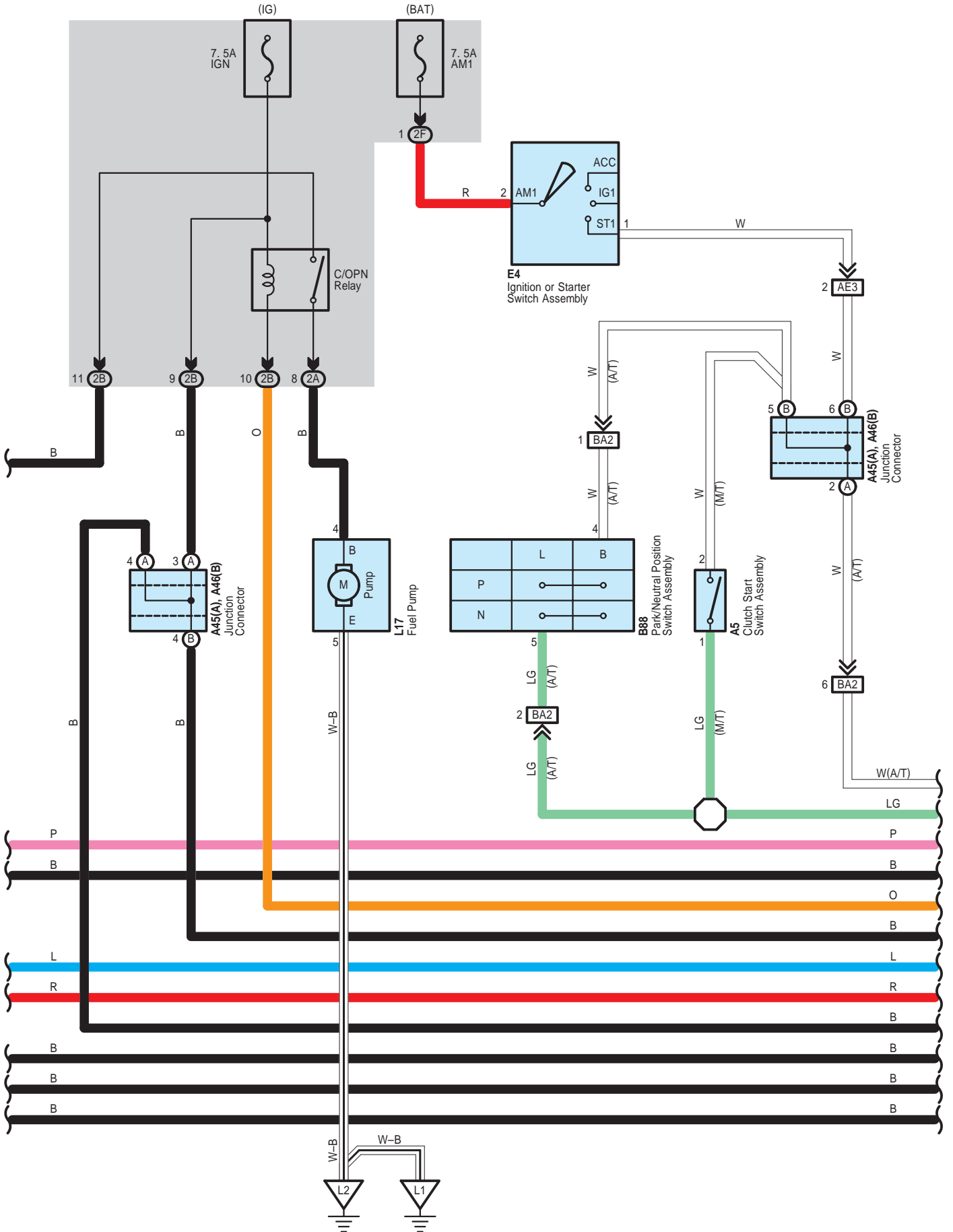

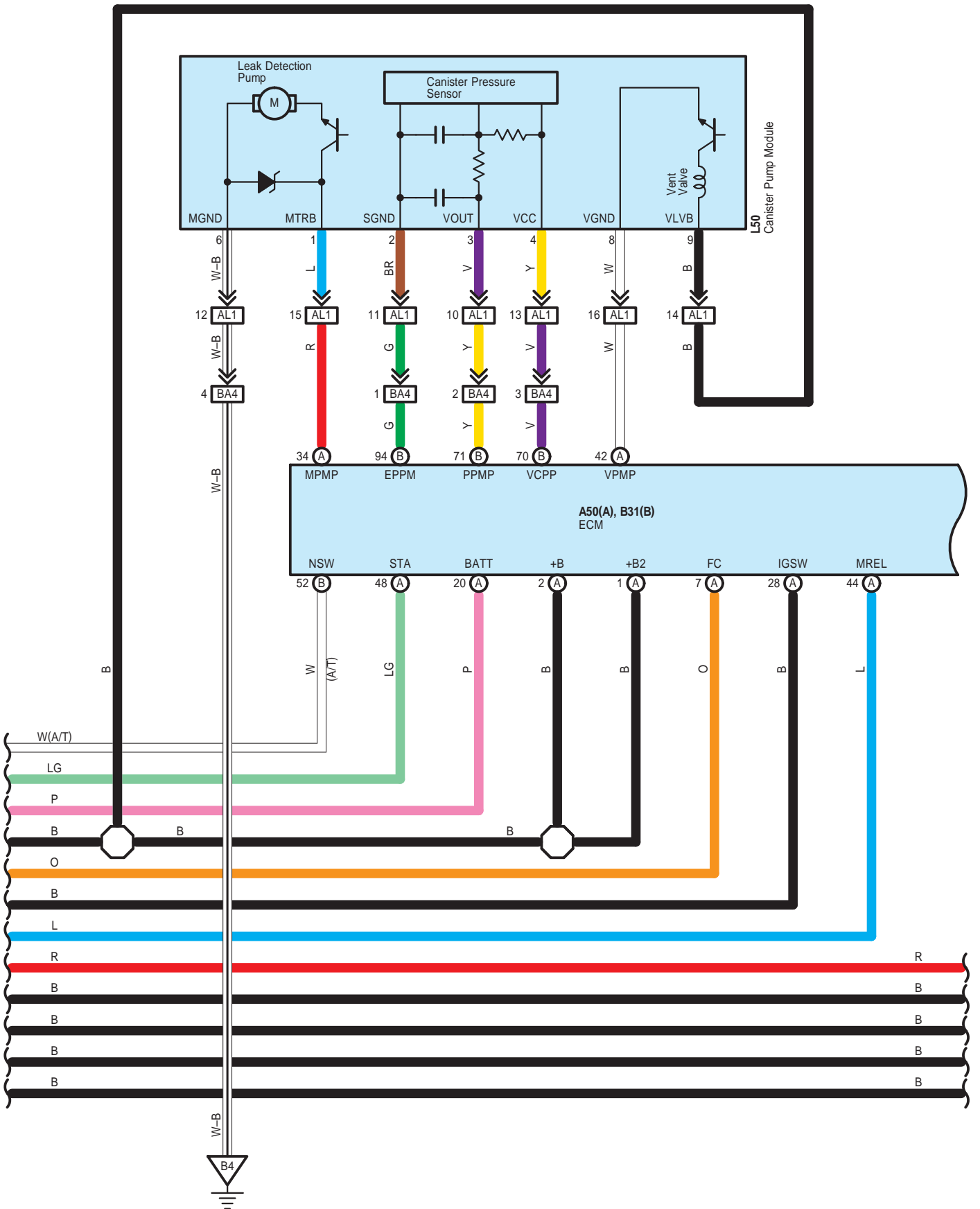

\* 1 : Shielded

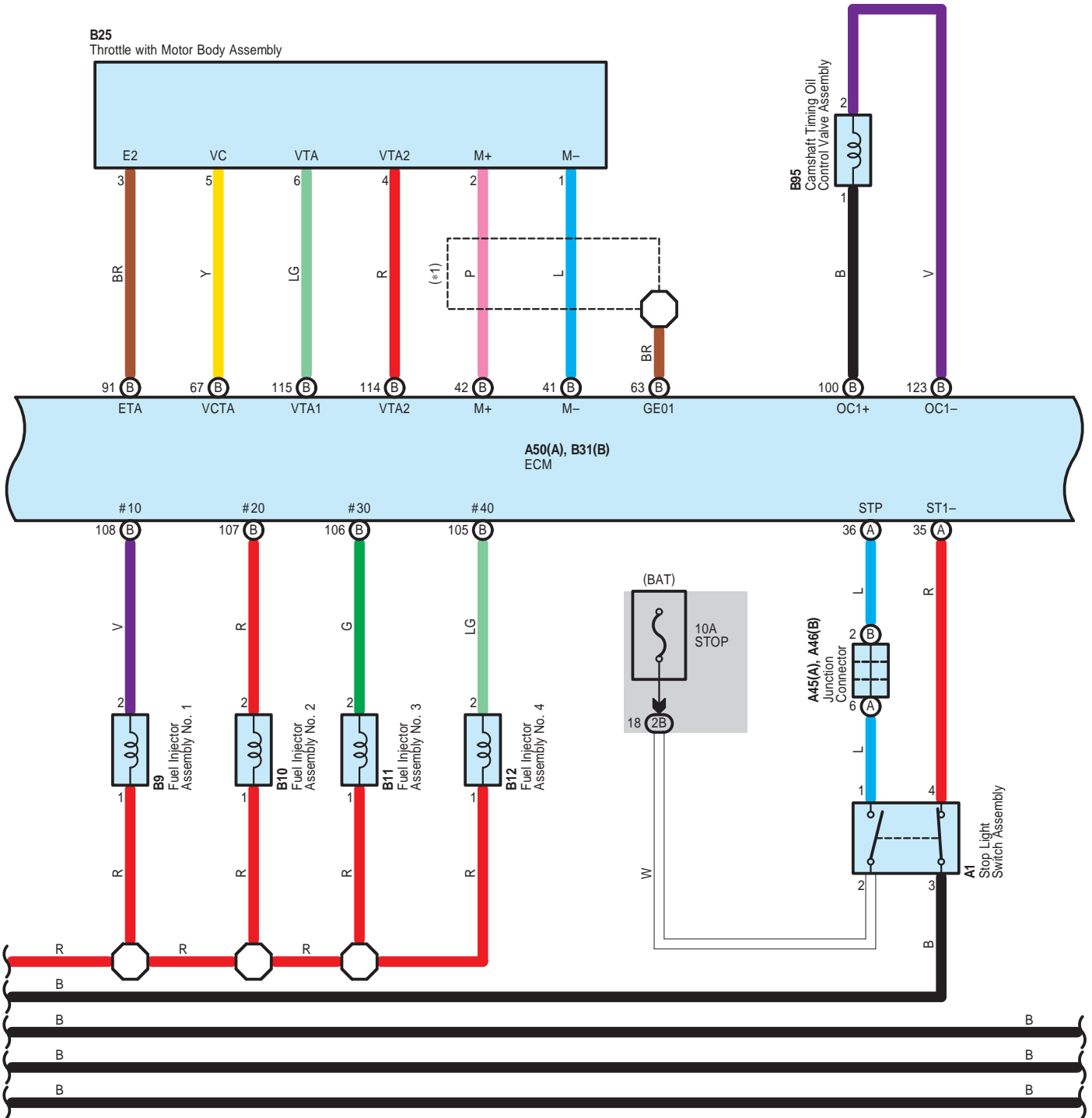

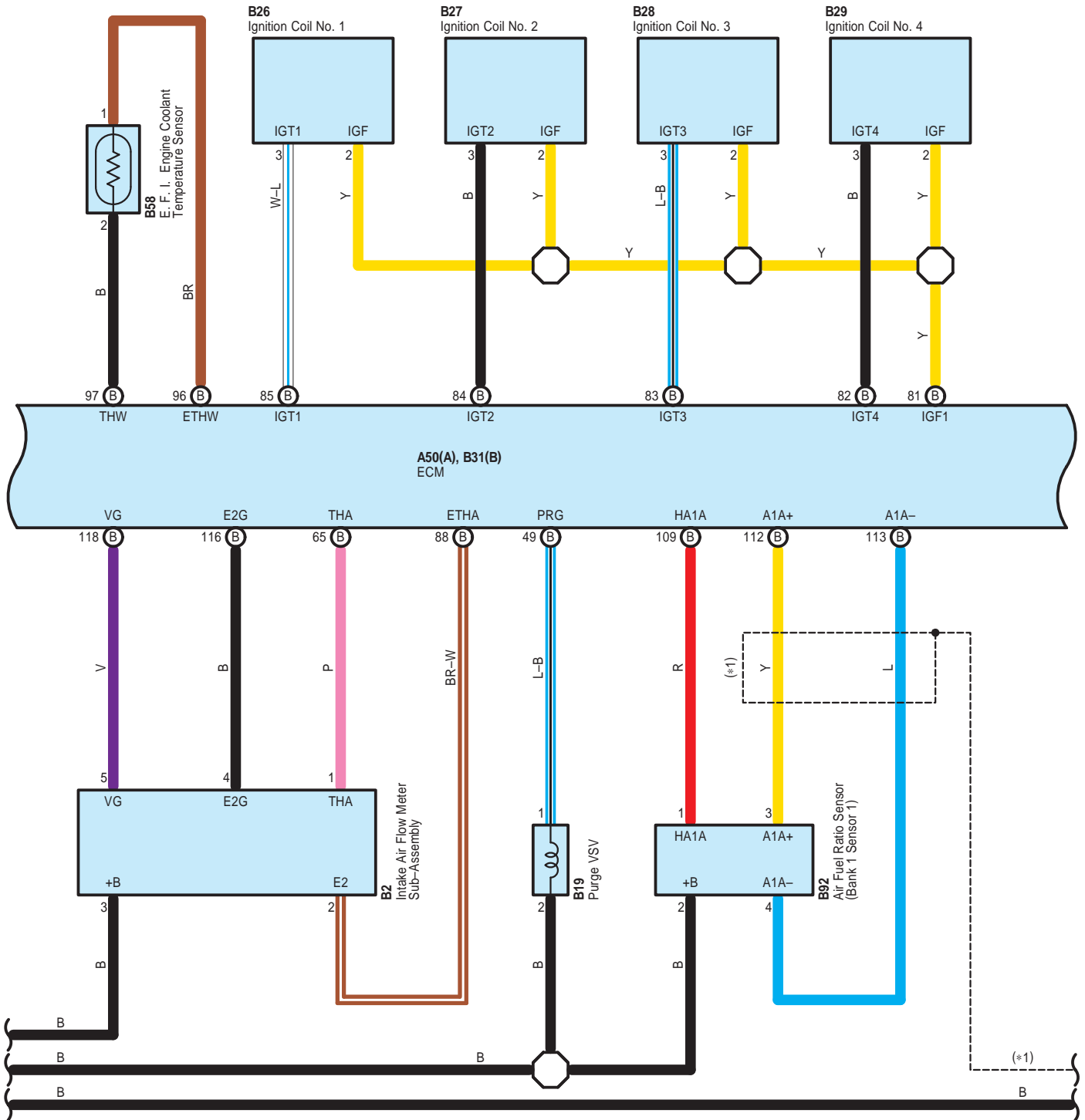

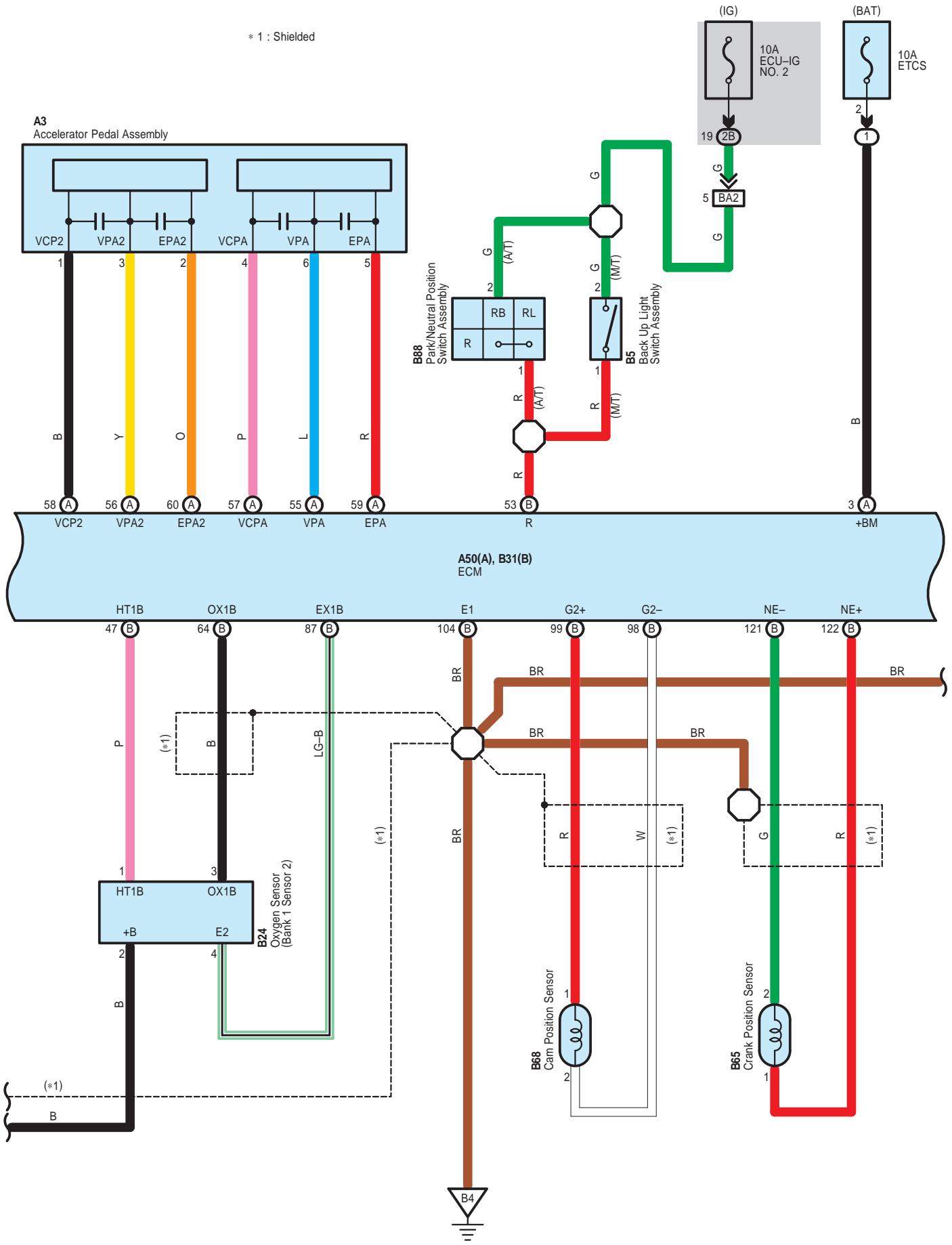



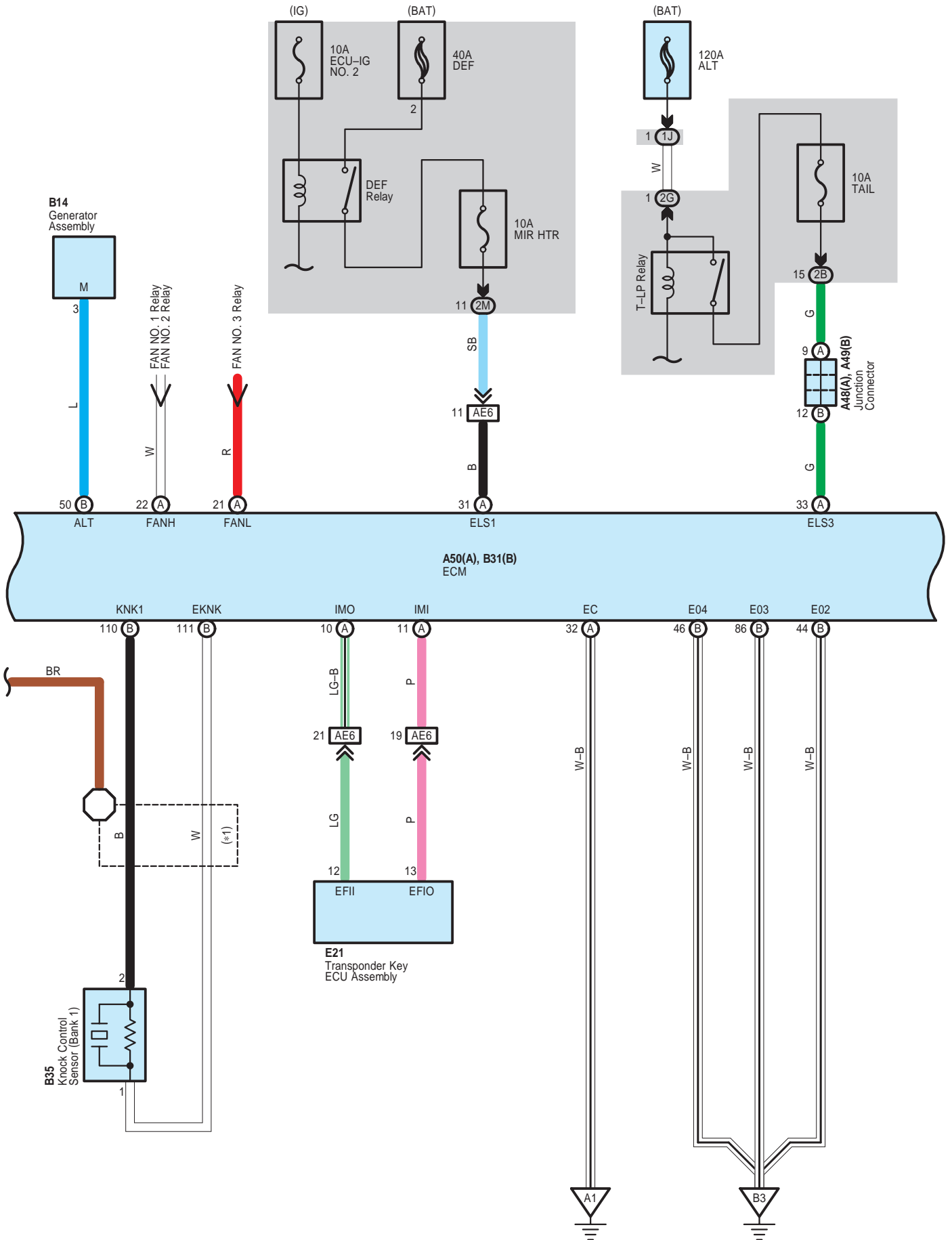

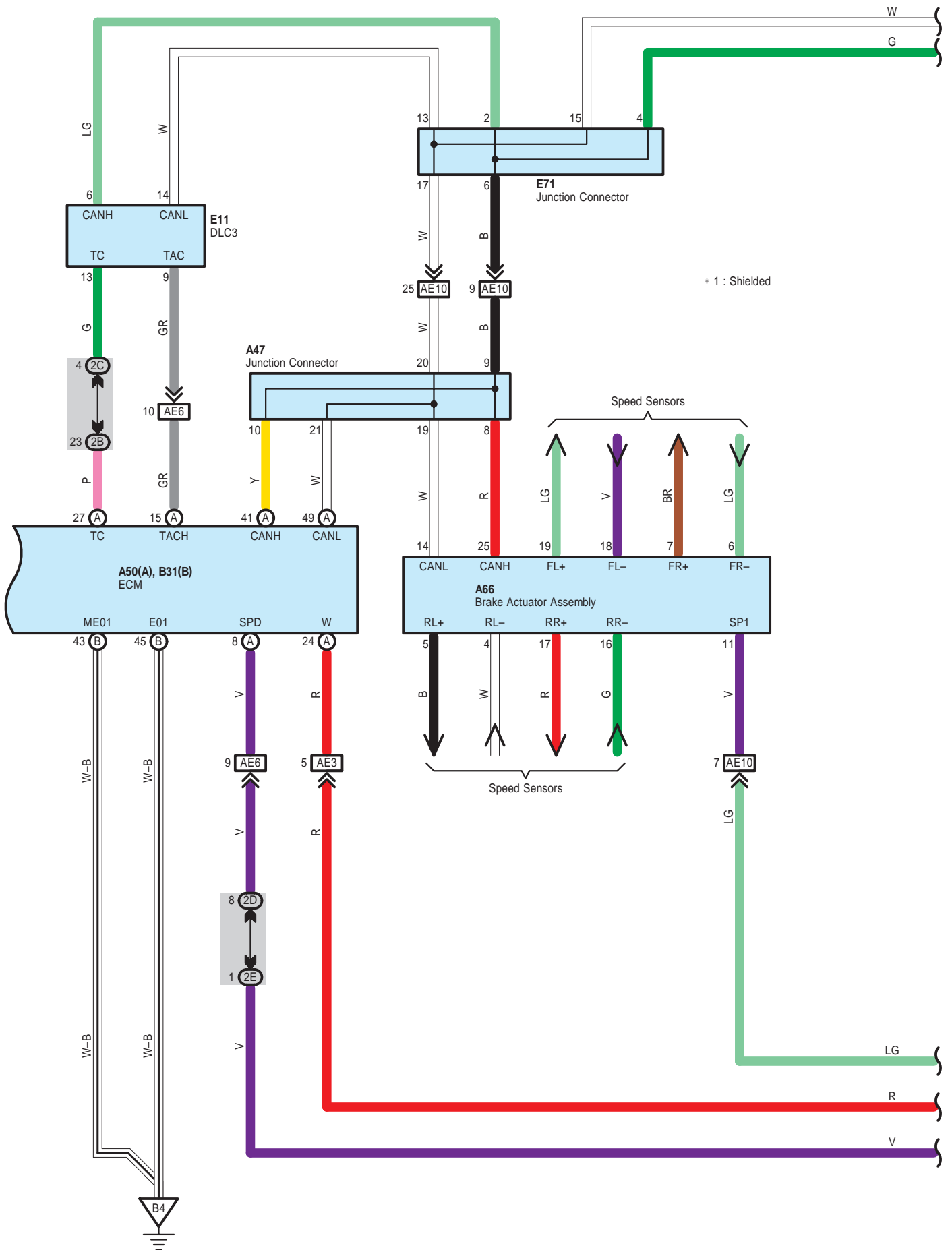

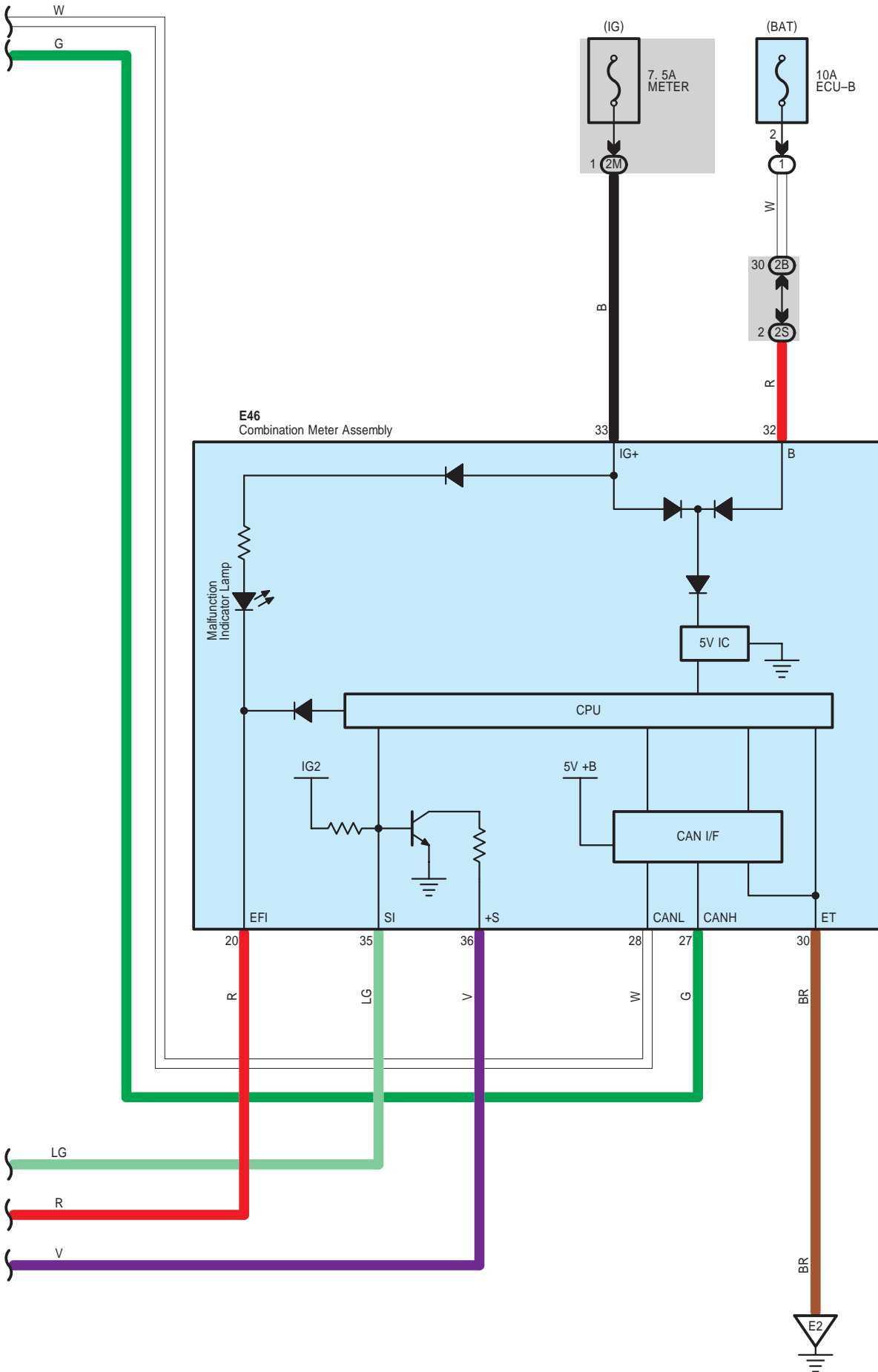

Engine Control <2AZ-FE , Except TMC Made>

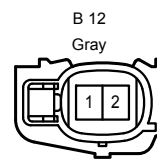
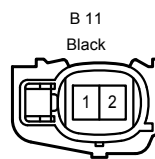
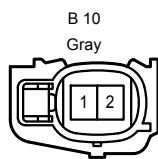
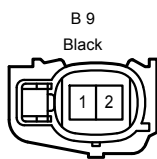
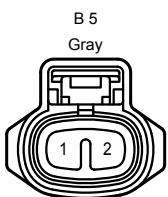
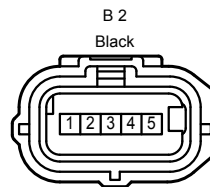
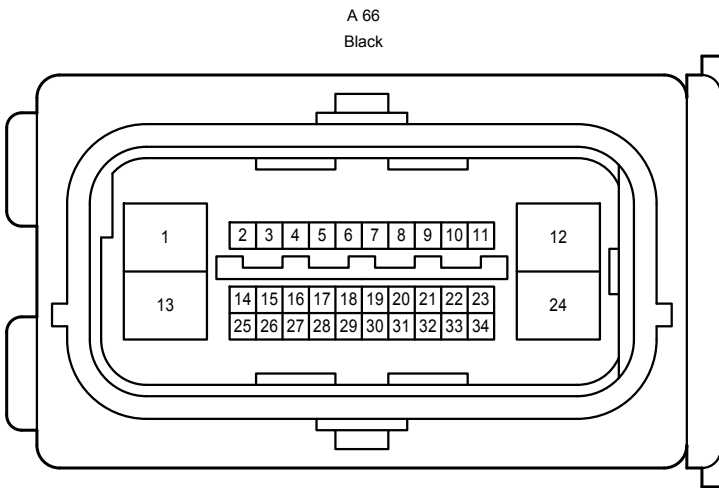
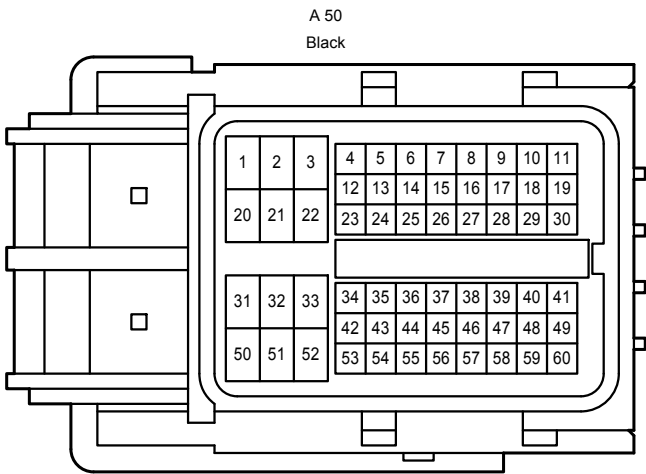
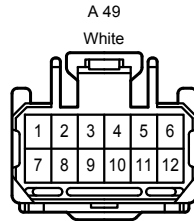
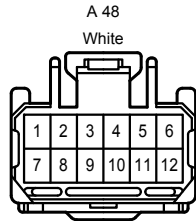
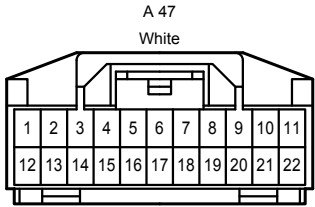
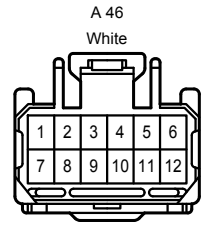
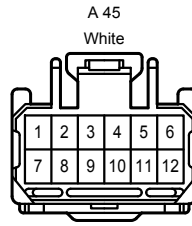
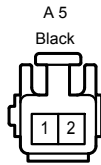
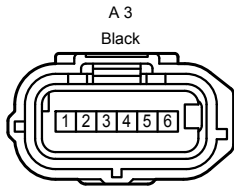
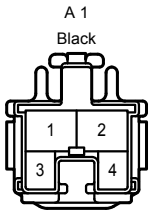



Engine Control <2AZ-FE , Except TMC Made>

E 21  
White

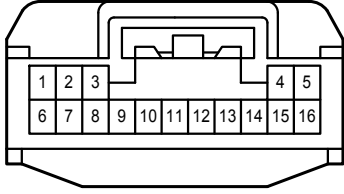

E 46  
White

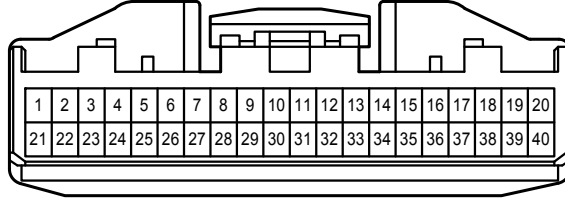

E 71  
White

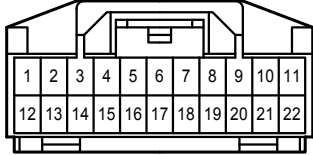

L 17  
White



L 50  
Black



1A  
White

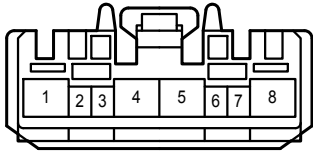

1B  
White

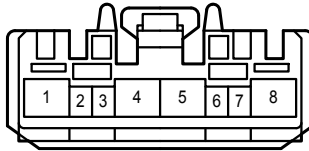

1J

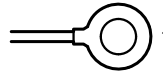

2A  
White

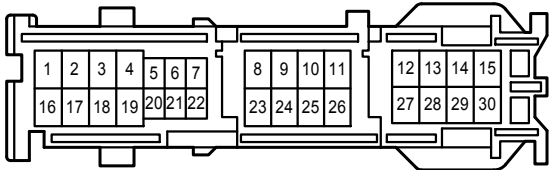

2B  
White

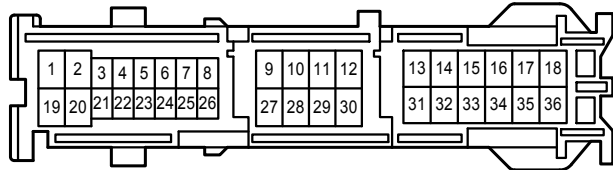

2C  
White

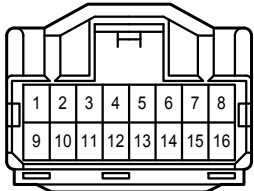

2D  
White

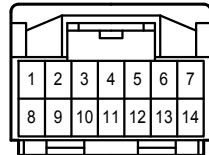

2E  
White

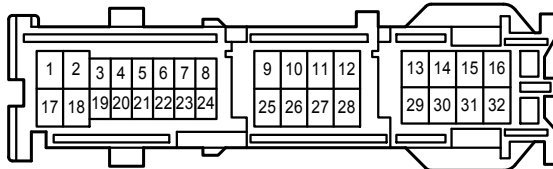

2F  
White

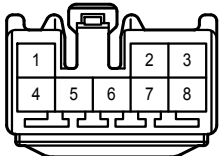

2G  
White

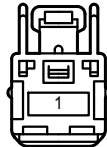

2M  
White

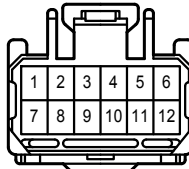

2S  
White

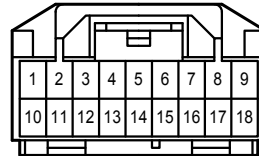

AE3  
White

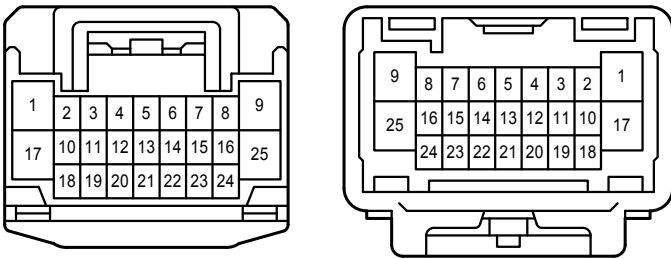

AE6  
Gray

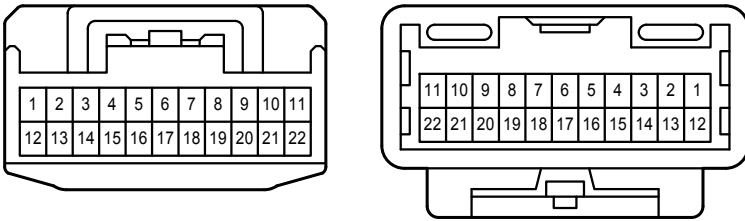

AE10  
Gray

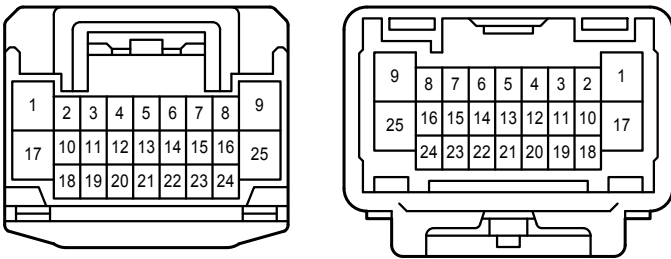

AL1  
White

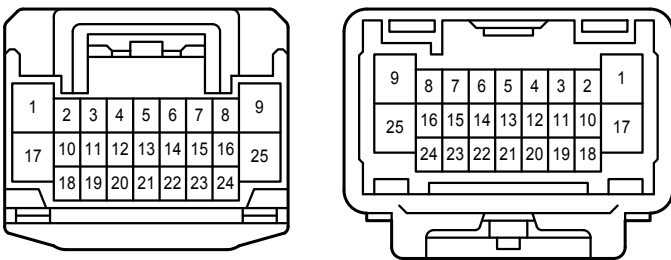

BA1  
White

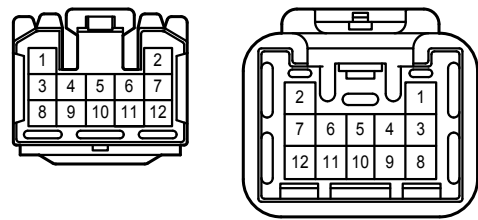

BA2  
White

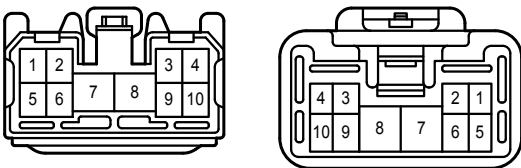

BA4  
Gray

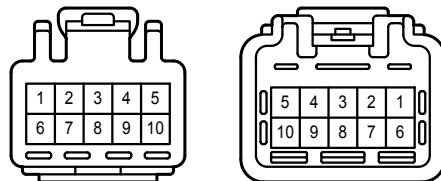

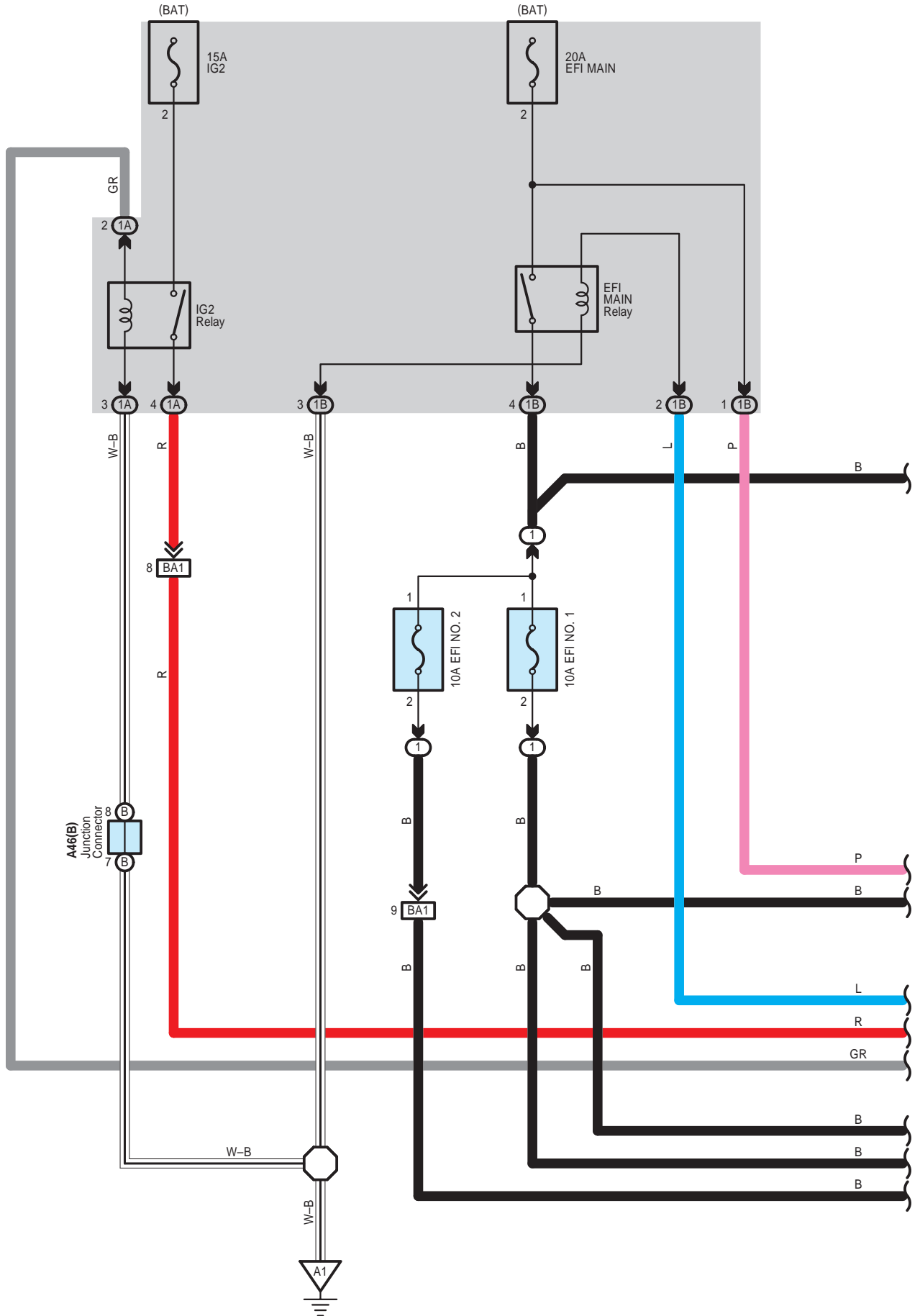



Engine Control <2ZR-FE , Except TMC Made>

- \* 1 : w/ Smart Key System
- \* 2 : w/o Smart Key System

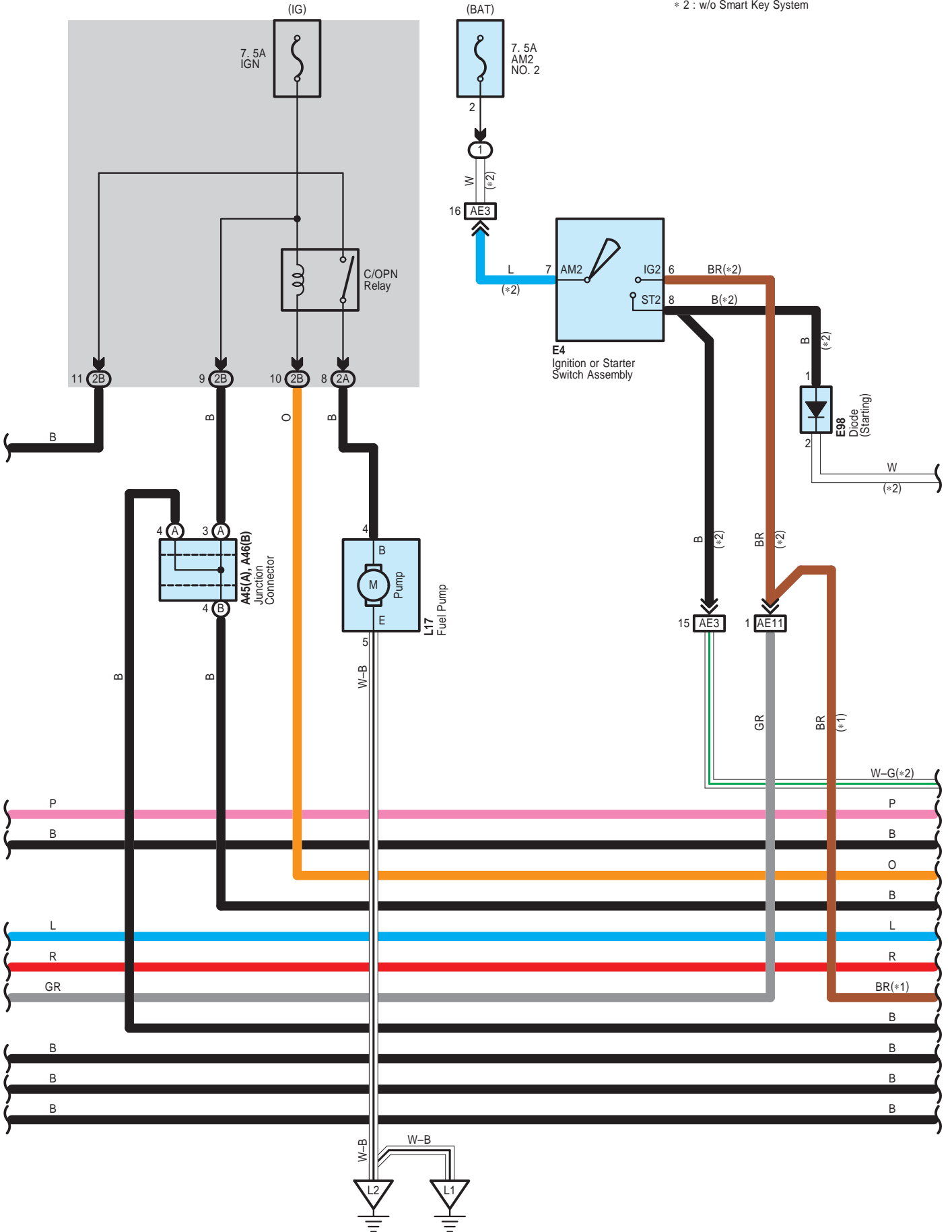

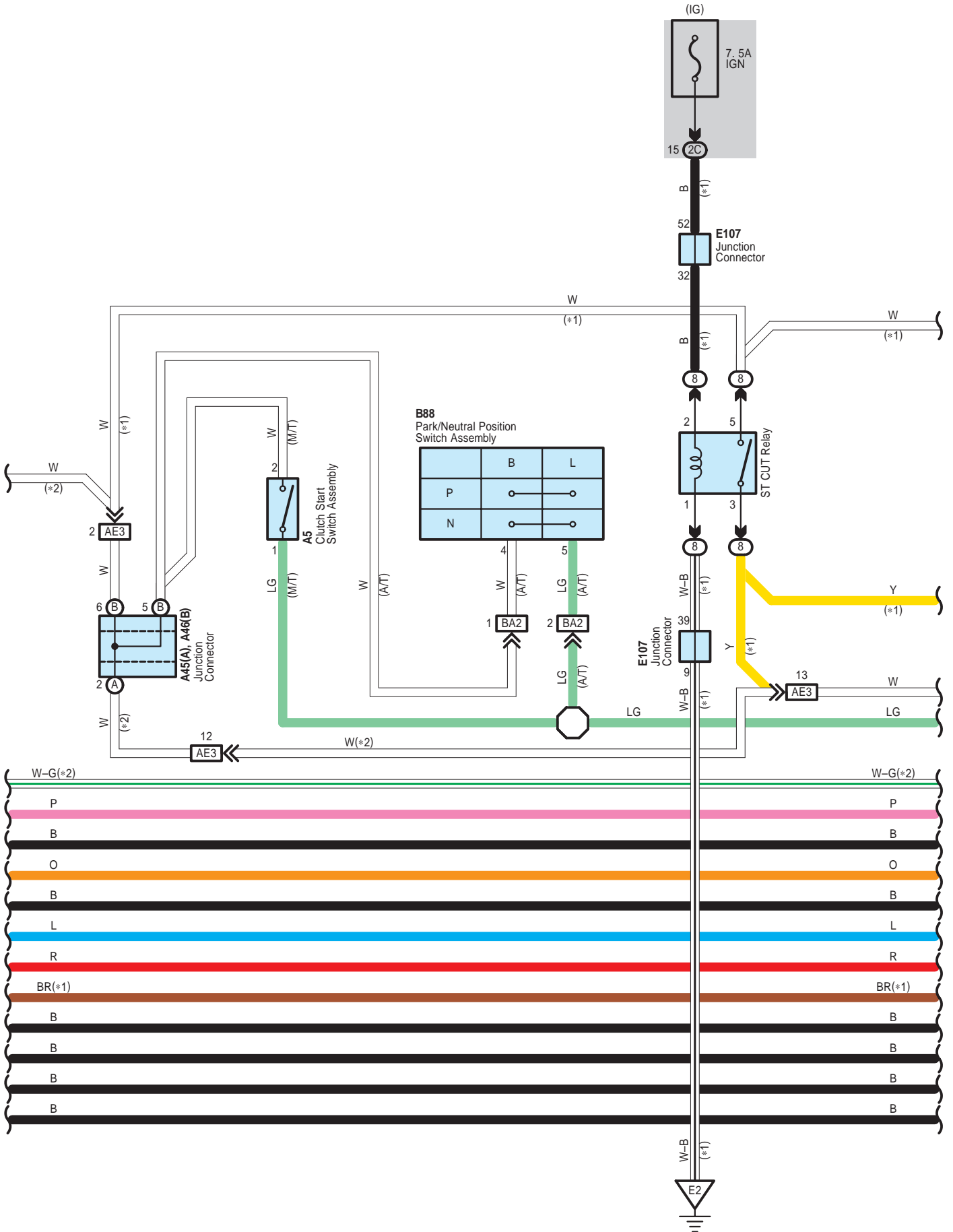

Engine Control <2ZR-FE , Except TMC Made>

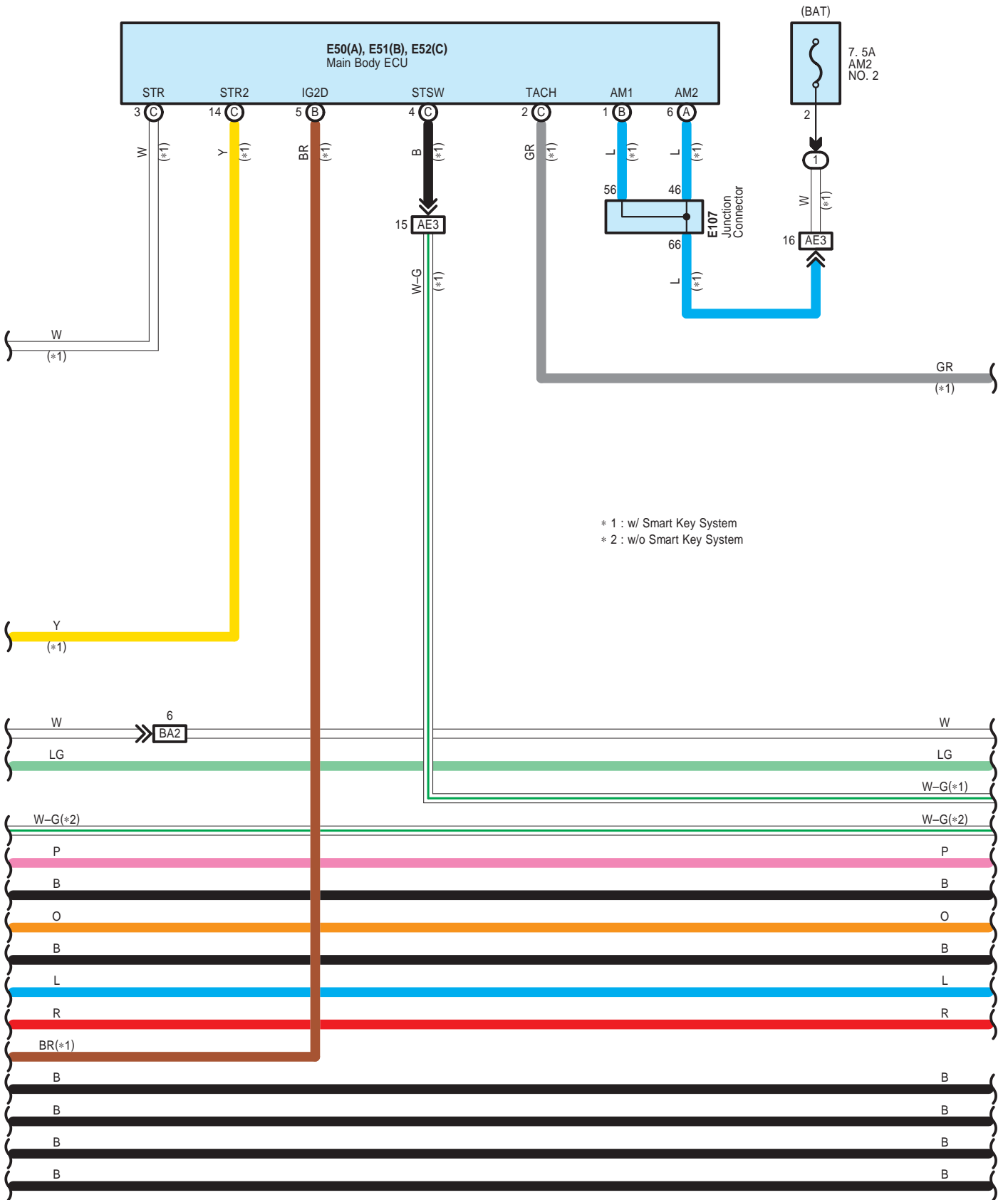

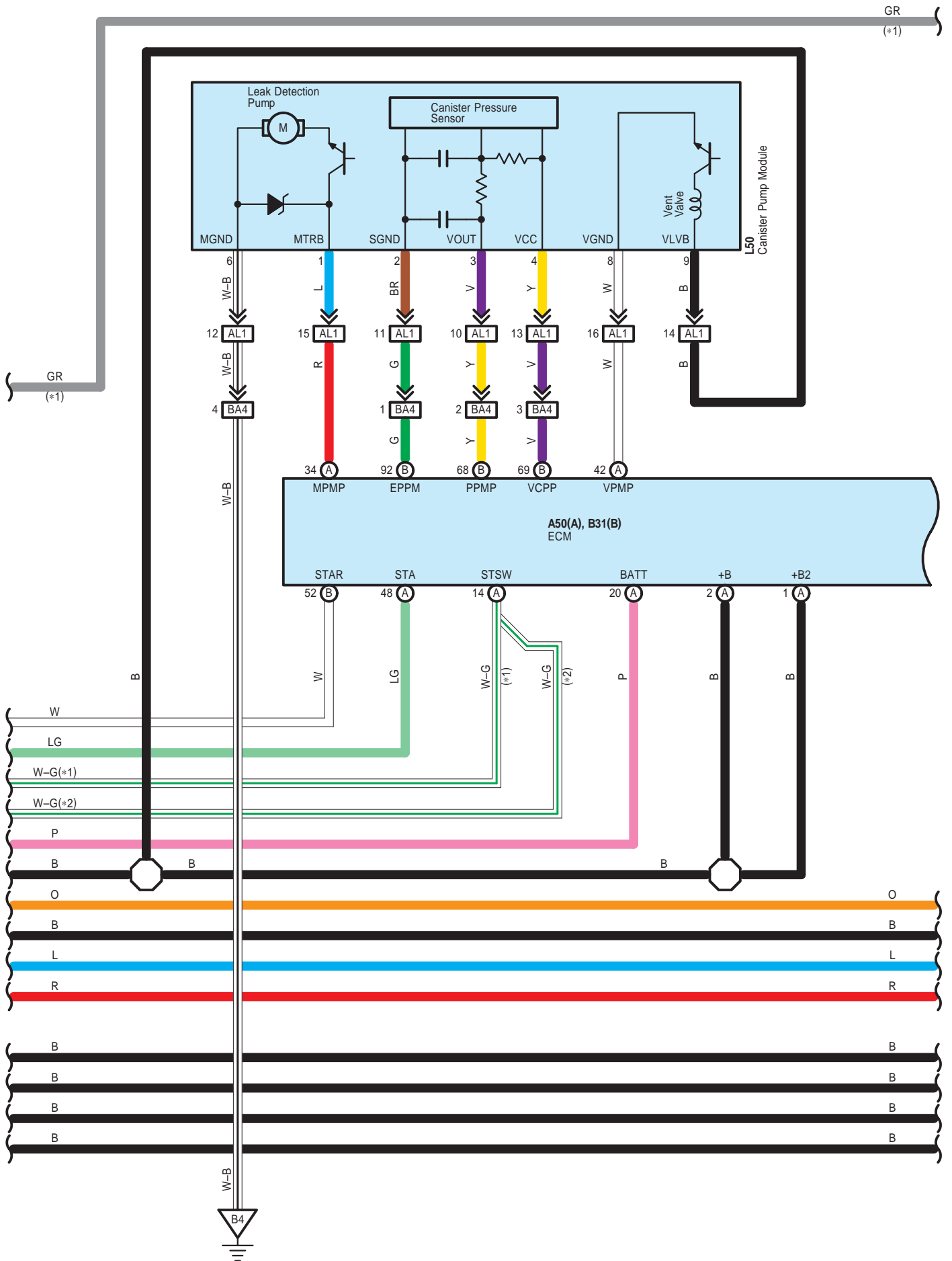

**Engine Control <2ZR-FE , Except TMC Made>**

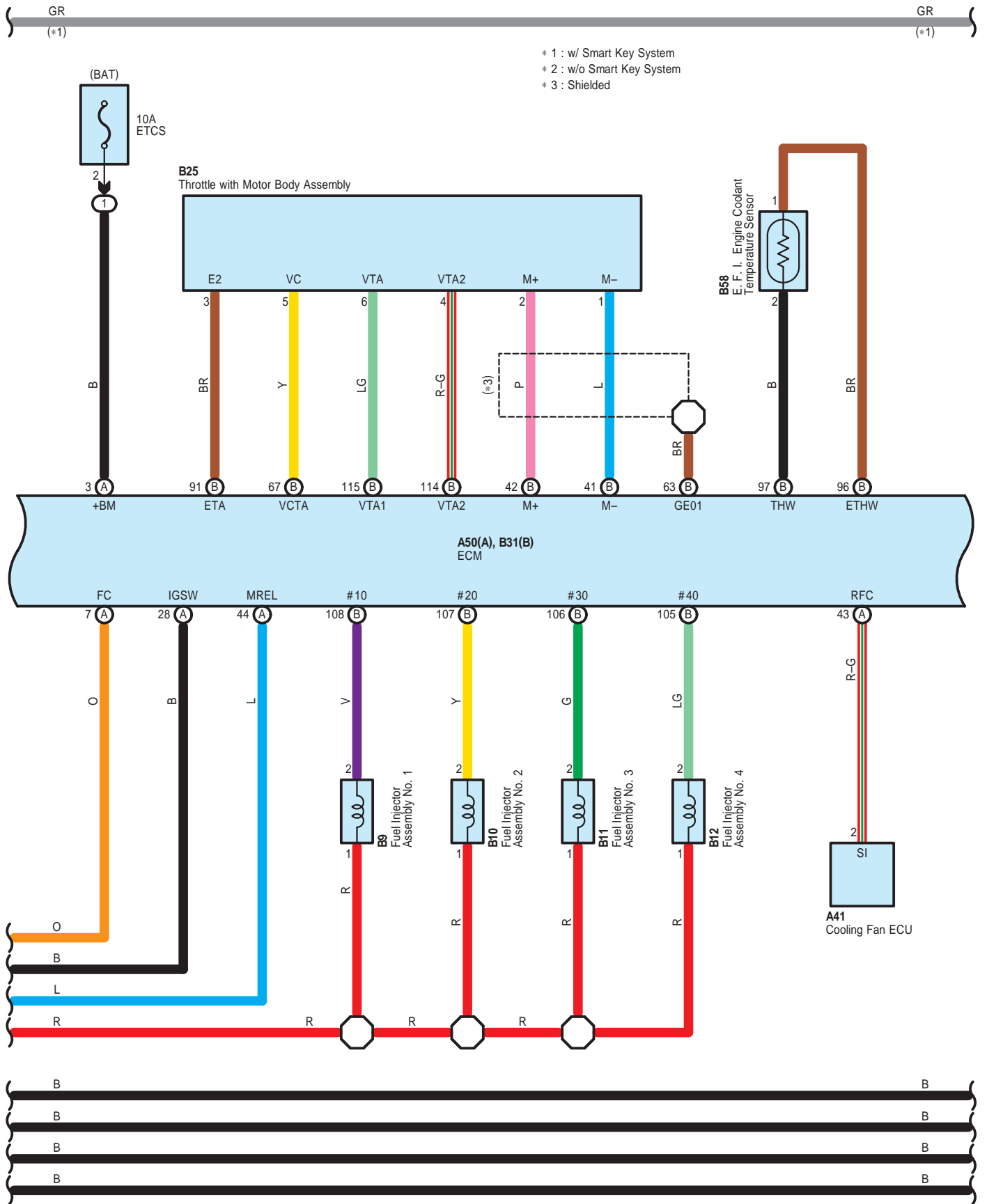

Engine Control <2ZR-FE , Except TMC Made>

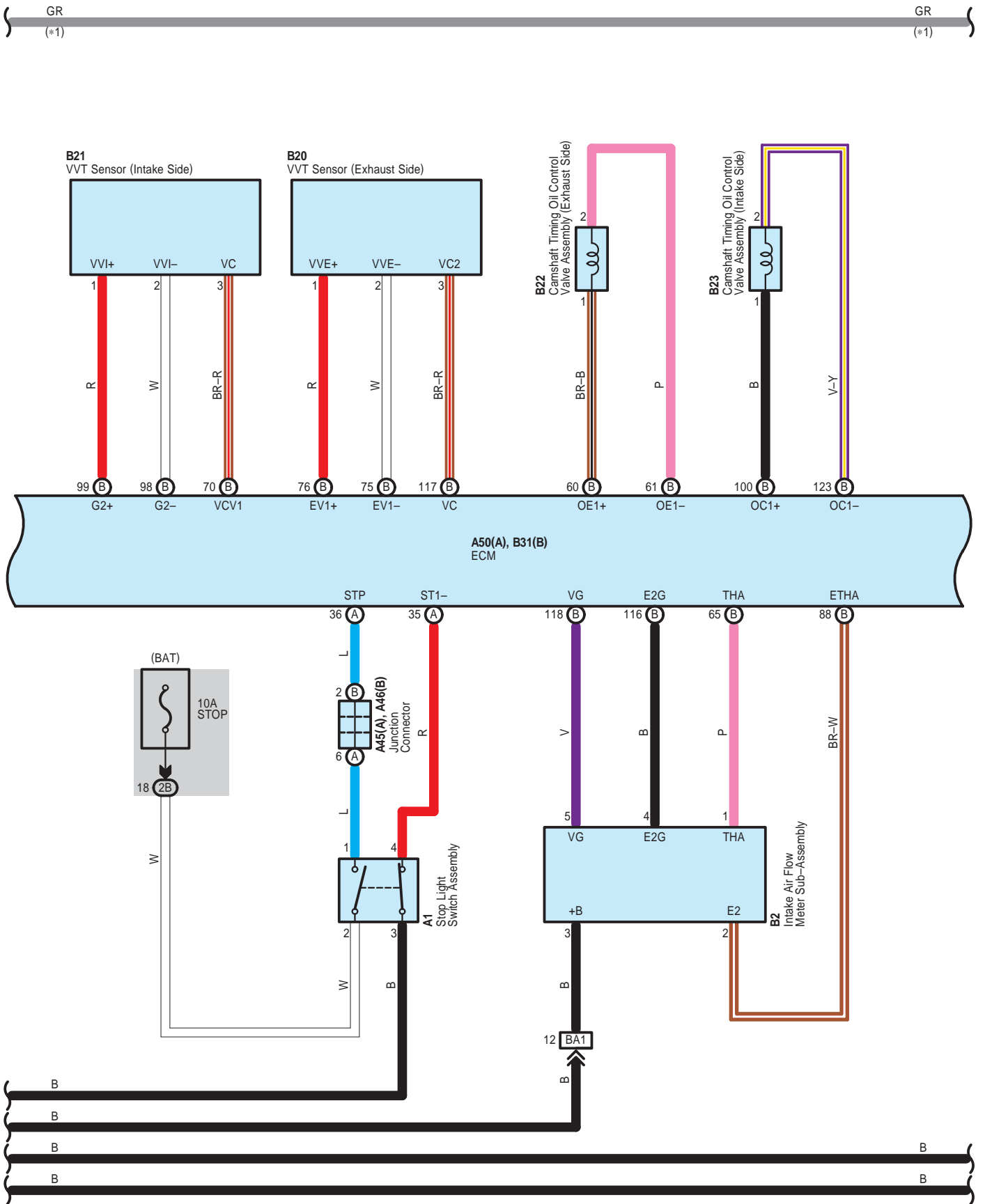

**Engine Control <2ZR-FE , Except TMC Made>**

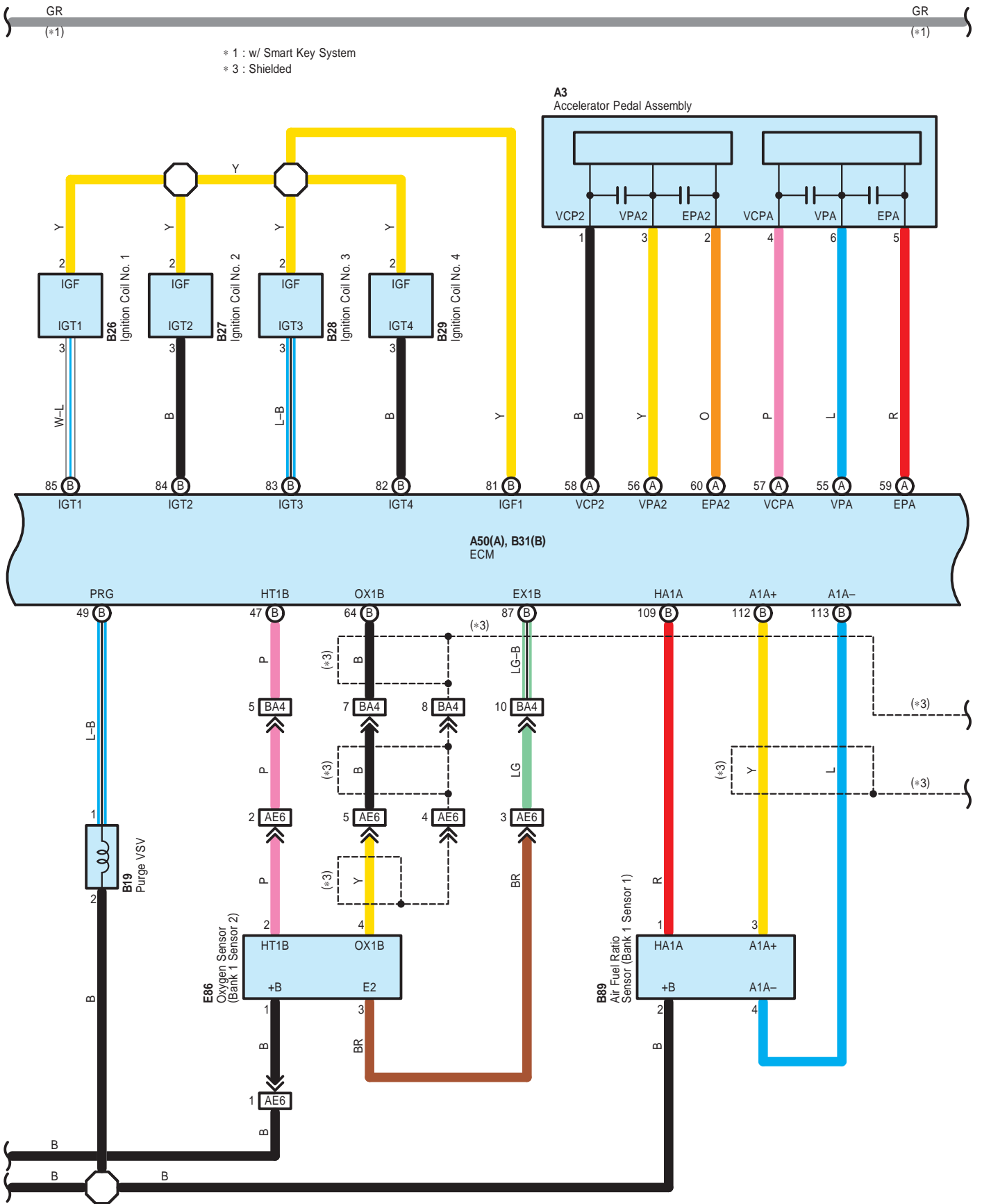

Engine Control <2ZR-FE , Except TMC Made>

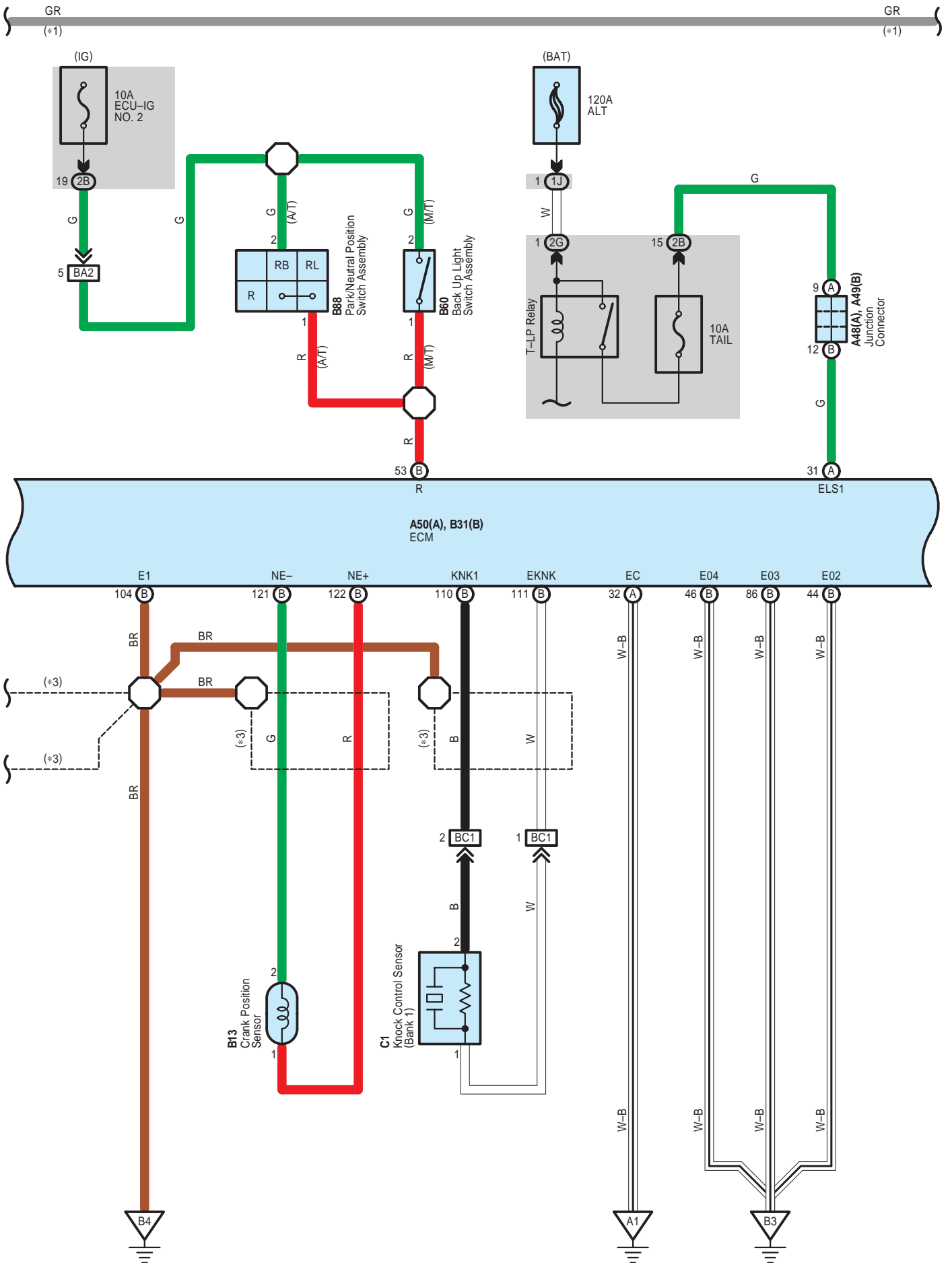



Engine Control <2ZR-FE , Except TMC Made>

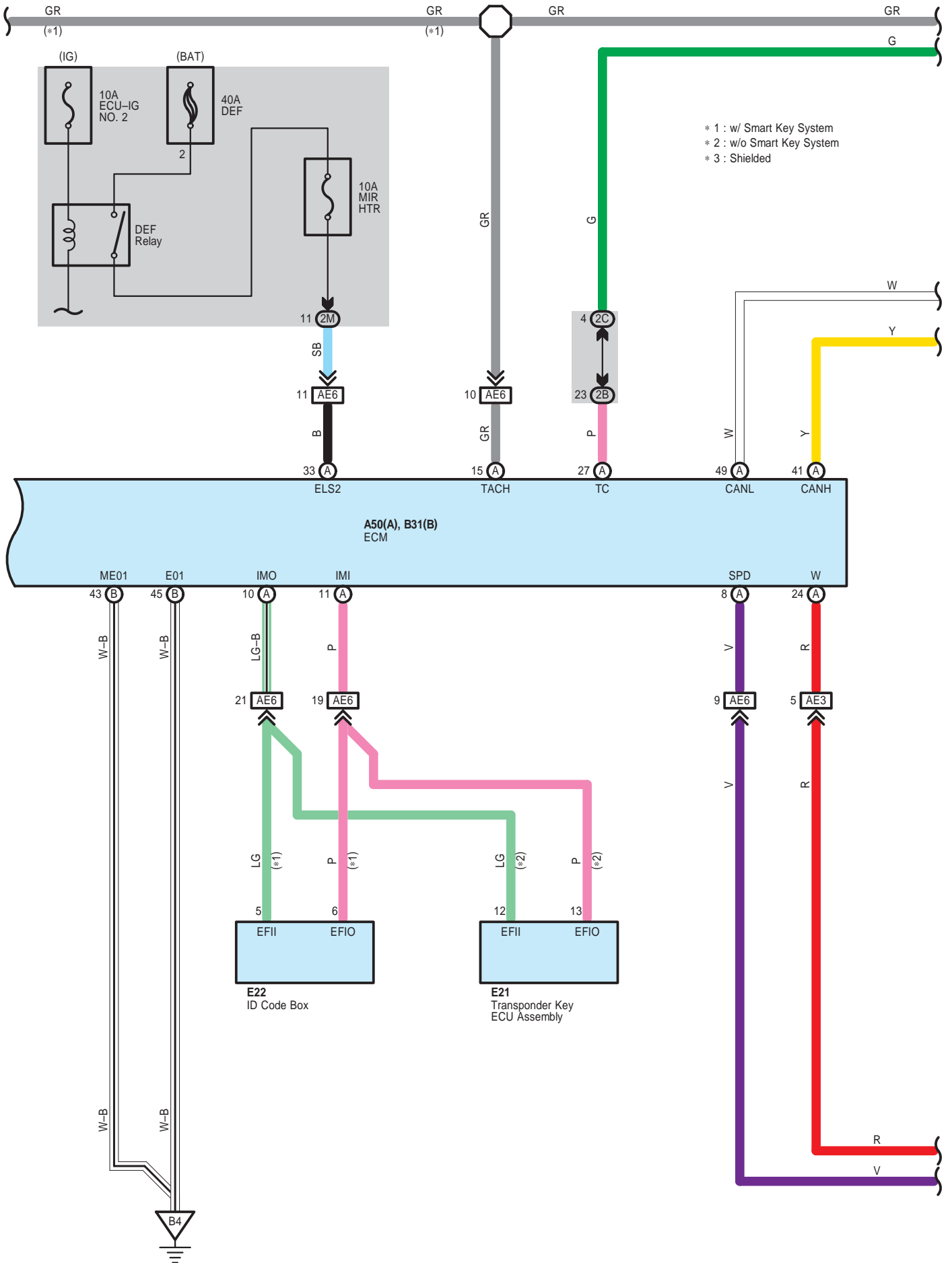

Engine Control <2ZR-FE , Except TMC Made>

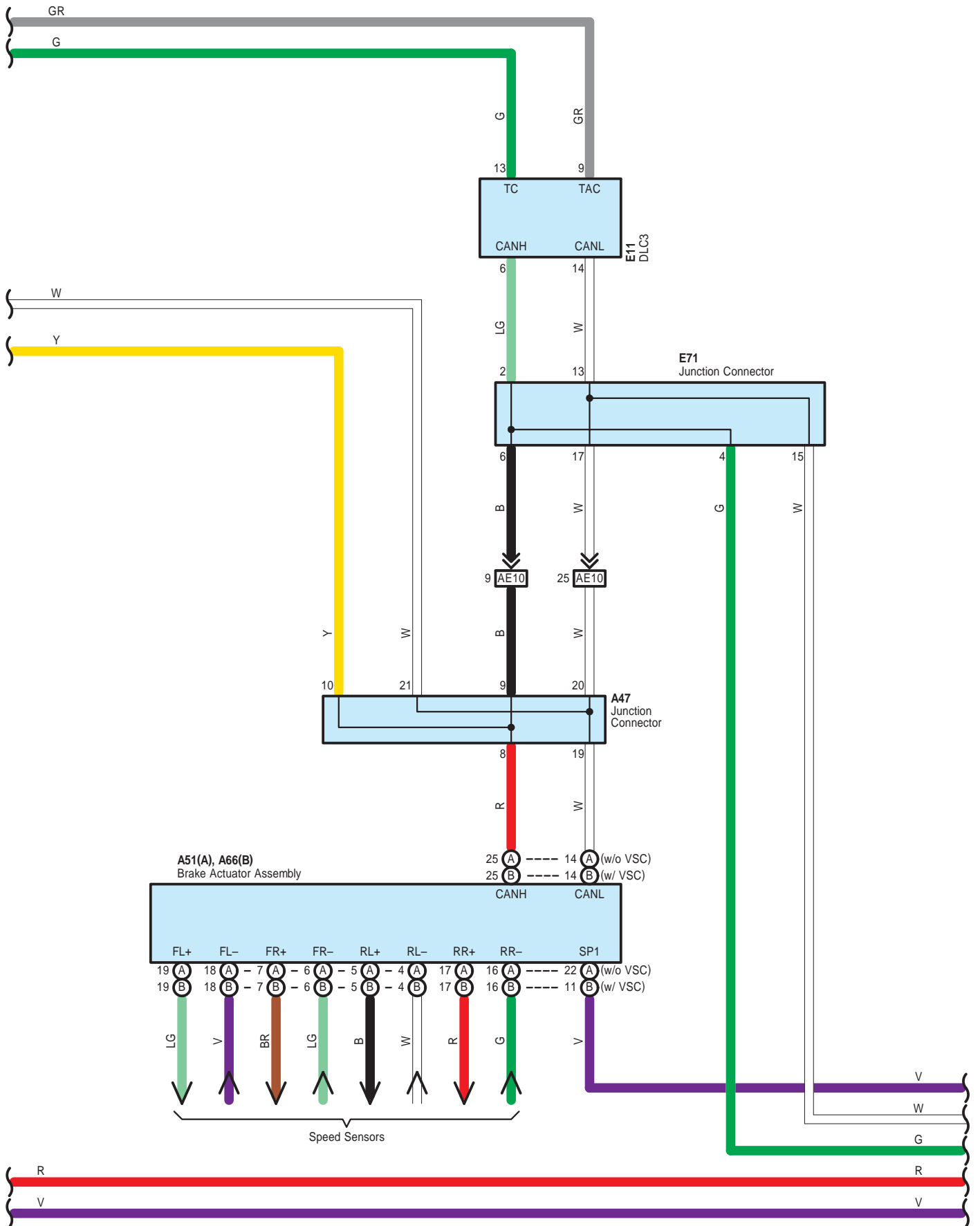

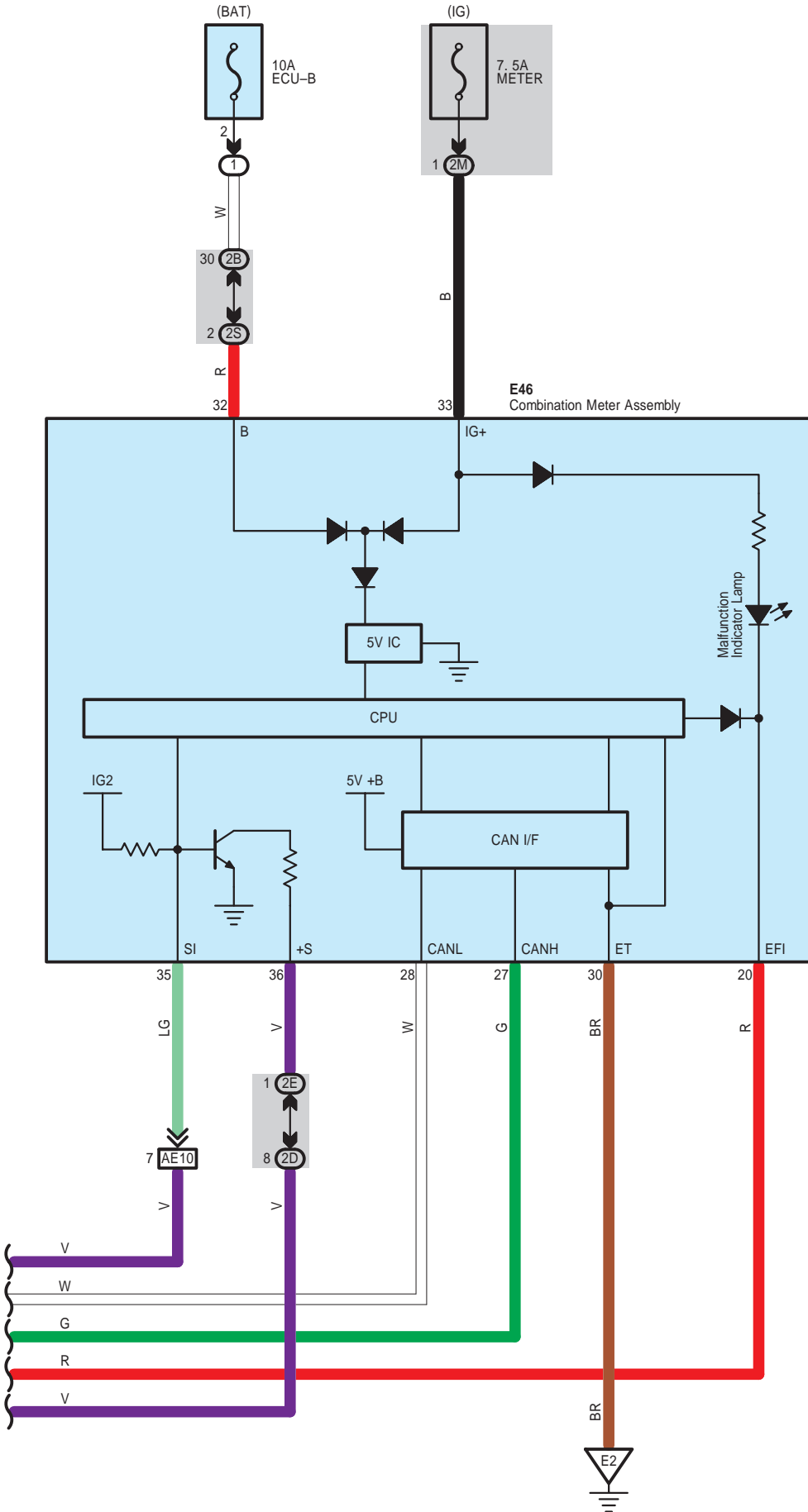

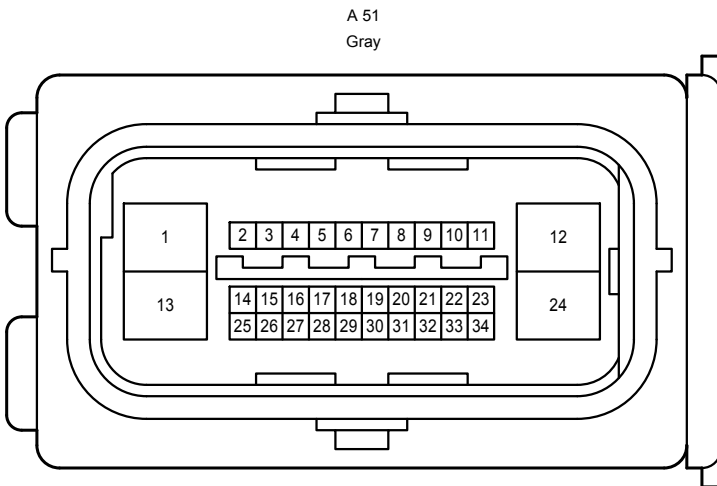
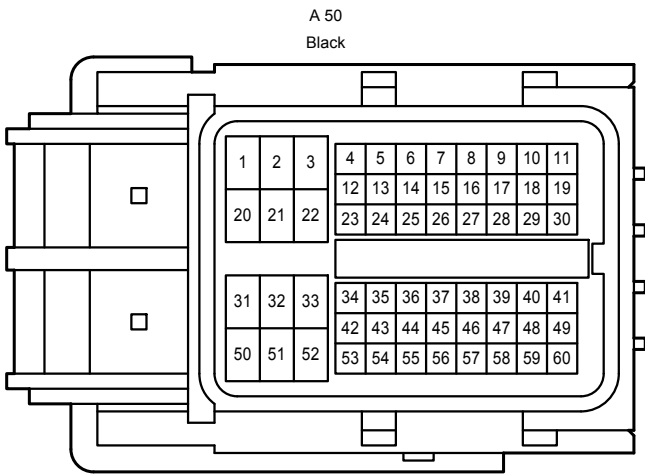
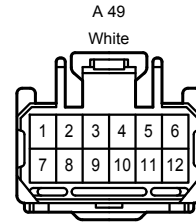
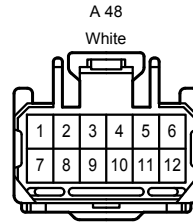
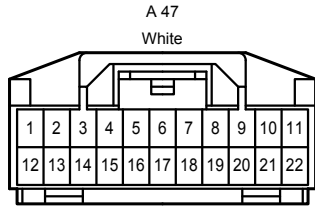
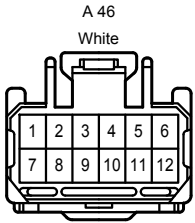
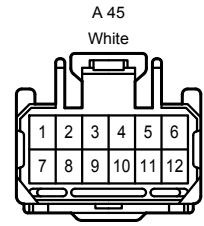
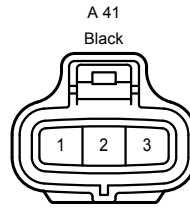
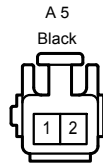
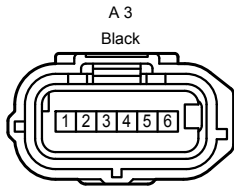
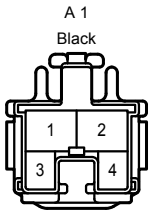

Engine Control <2ZR-FE , Except TMC Made>

A 66  
Black

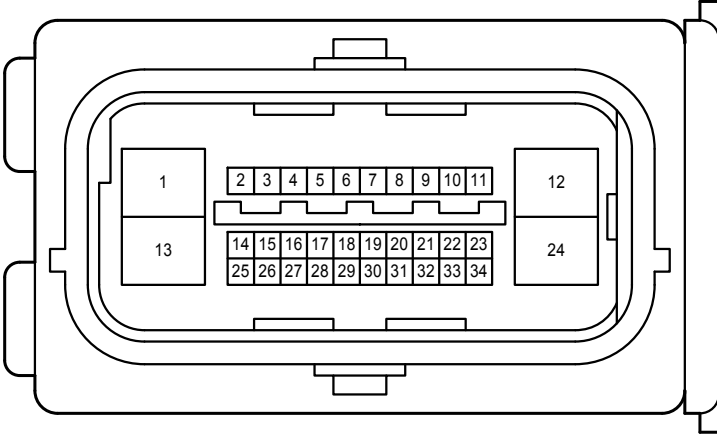

B 2  
Black



B 9  
Black

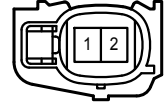

B 10  
Gray

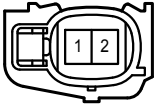

B 11  
Black

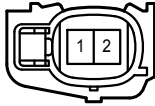

B 12  
Gray

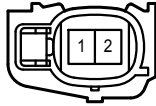

B 13  
Black

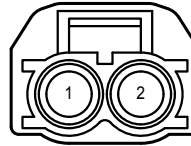

B 19  
Blue

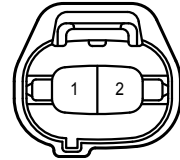

B 20  
Black

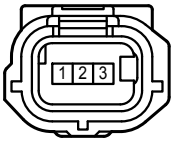

B 21  
Gray

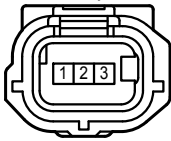

B 22  
Black



B 23  
Gray



B 25  
Black

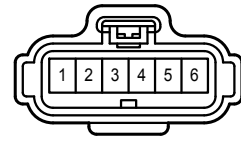

B 26  
Black

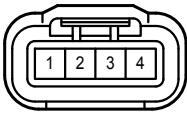

B 27  
Gray

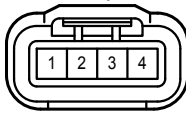

B 28  
Black

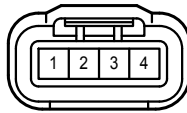

B 29  
Gray

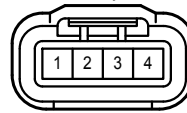

B 31  
Black

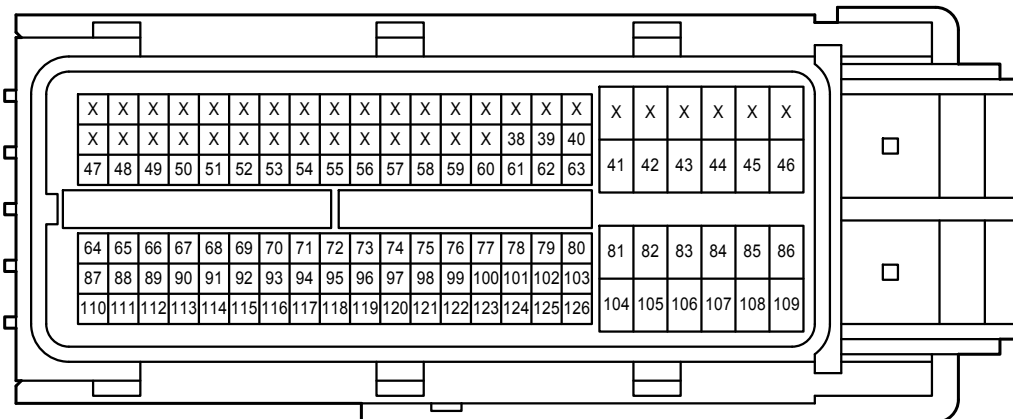

B 58  
Gray



Engine Control <2ZR-FE , Except TMC Made>

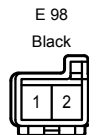
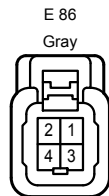
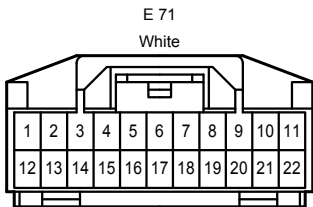
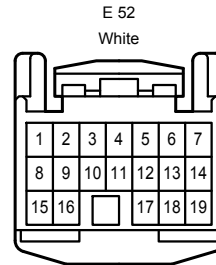
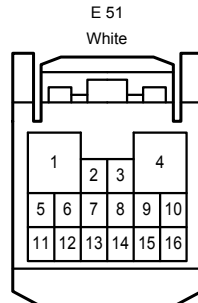
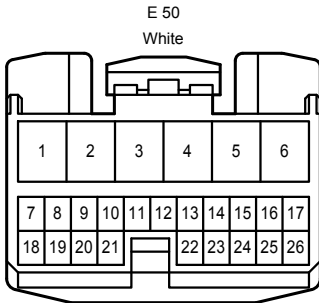
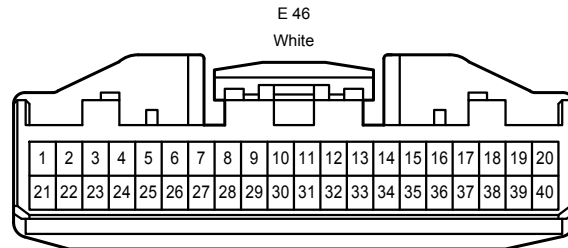
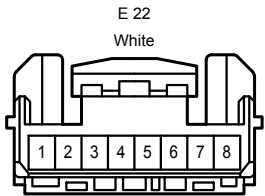
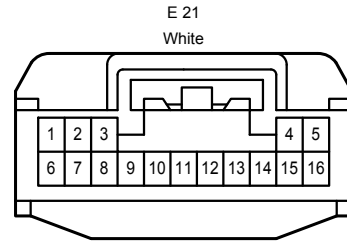
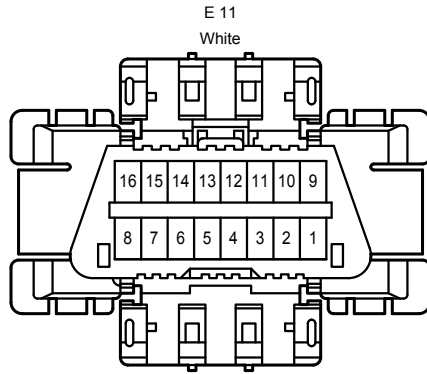
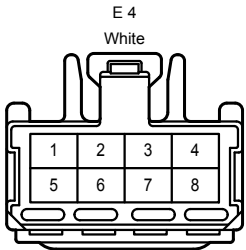
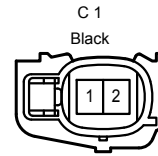
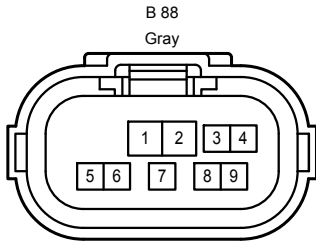
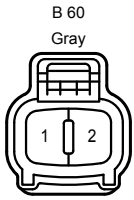

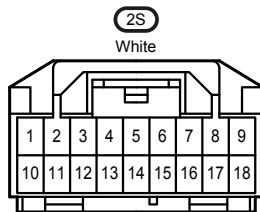
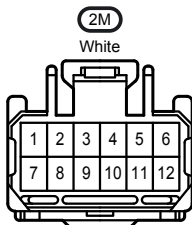
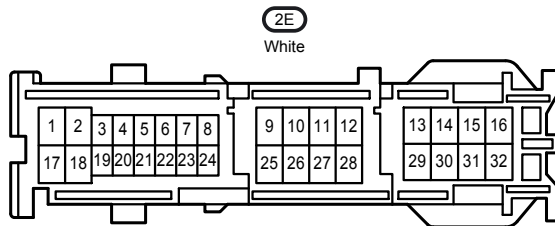
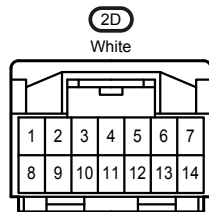
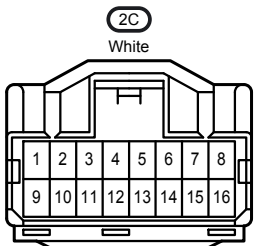
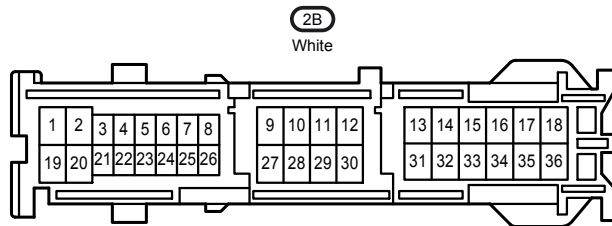
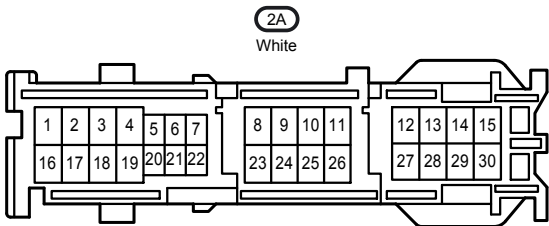
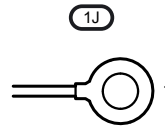
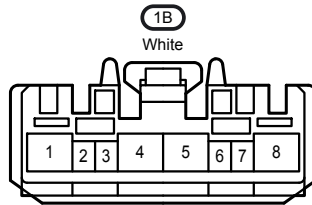
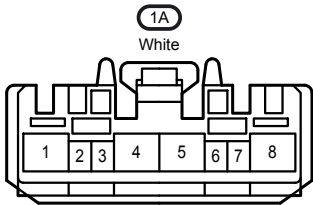
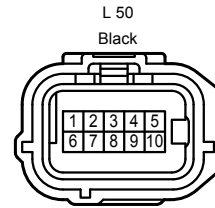
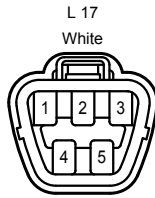
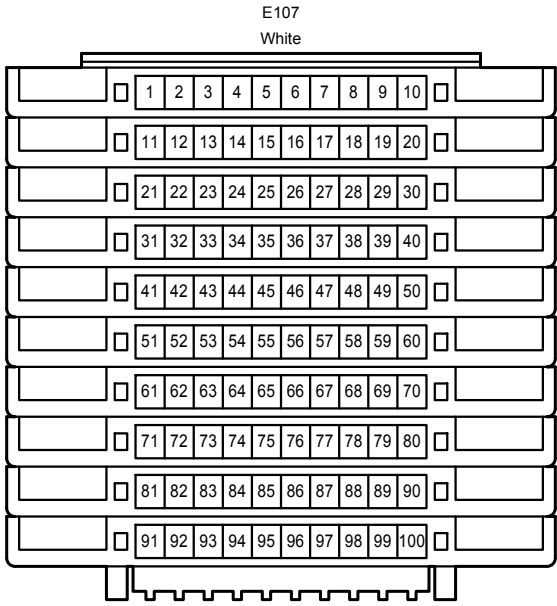

AE3  
White

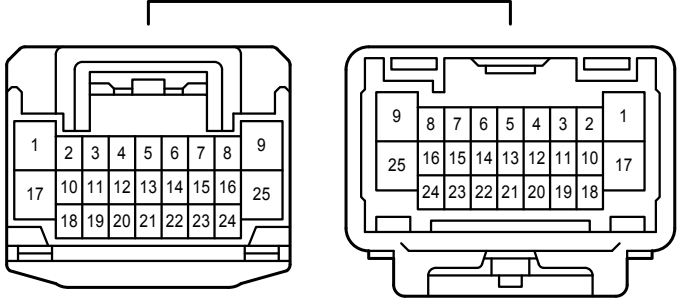

AE6  
Gray

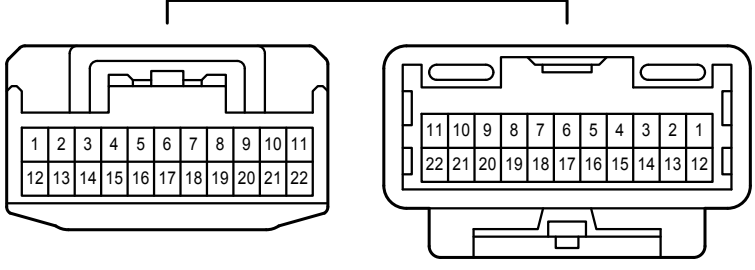

AE10  
Gray

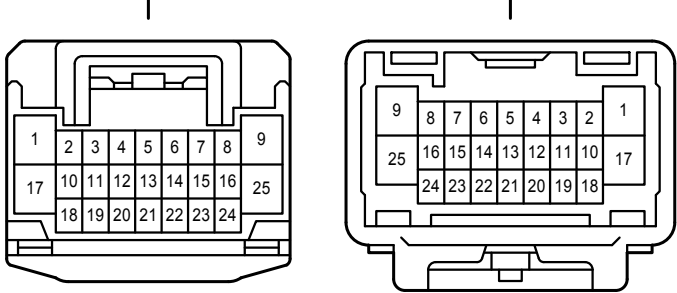

AE11  
White

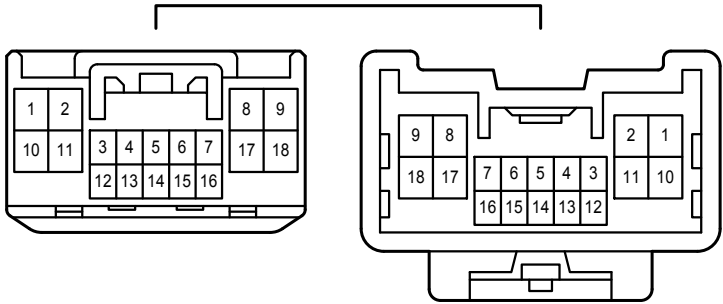



AL1  
White

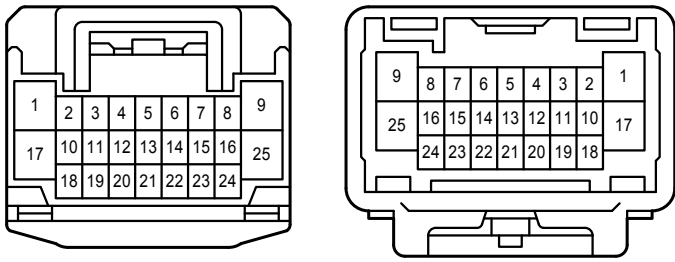

BA1  
White

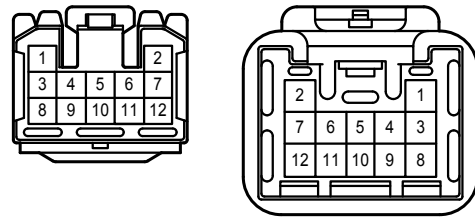

BA2  
White

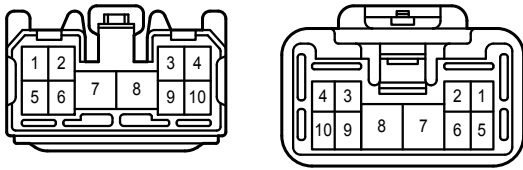

BA4  
Gray

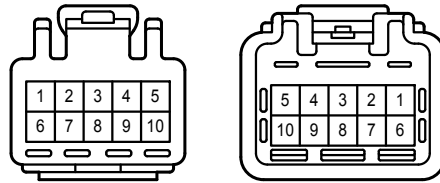

BC1  
Gray

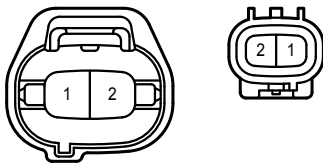

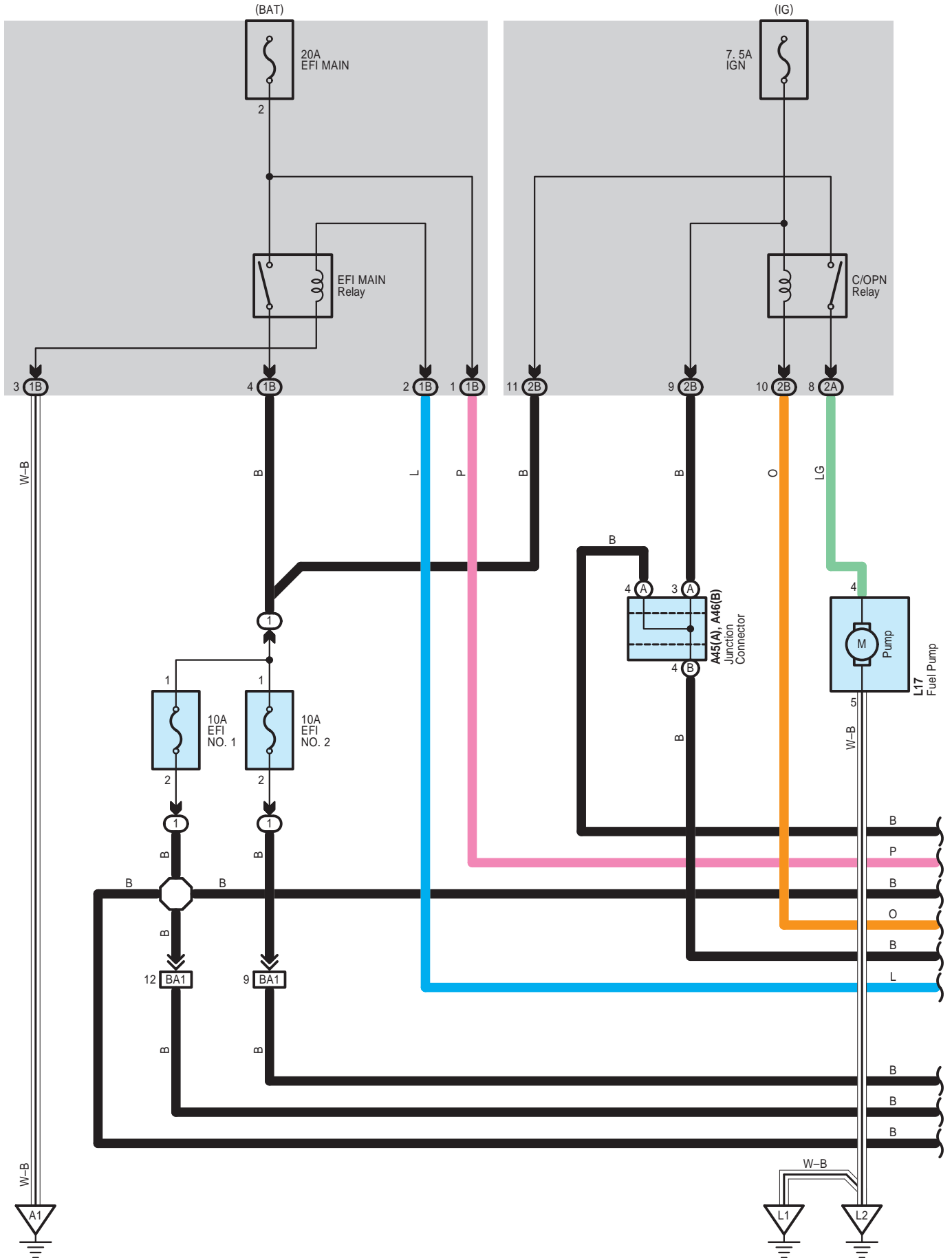

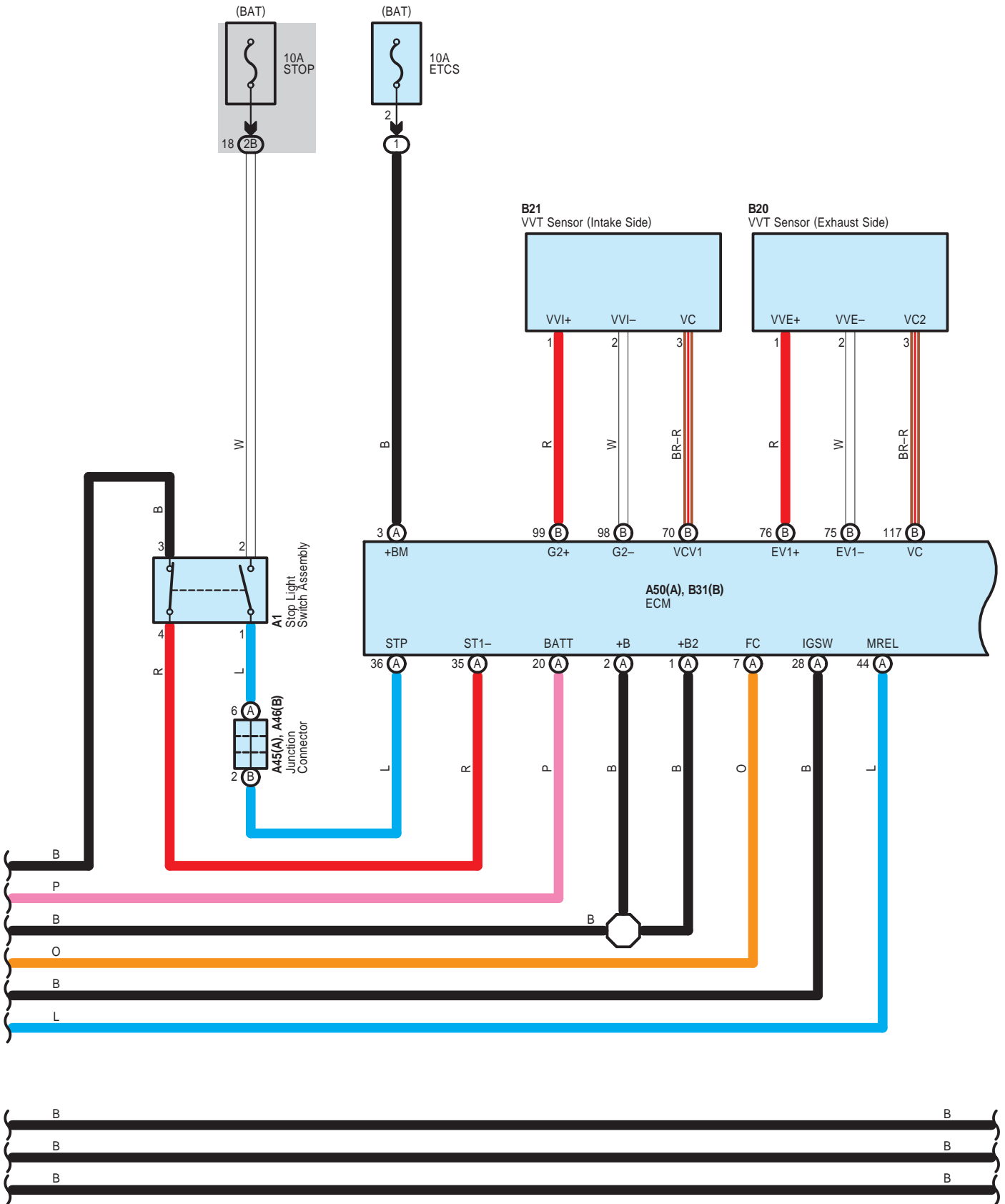

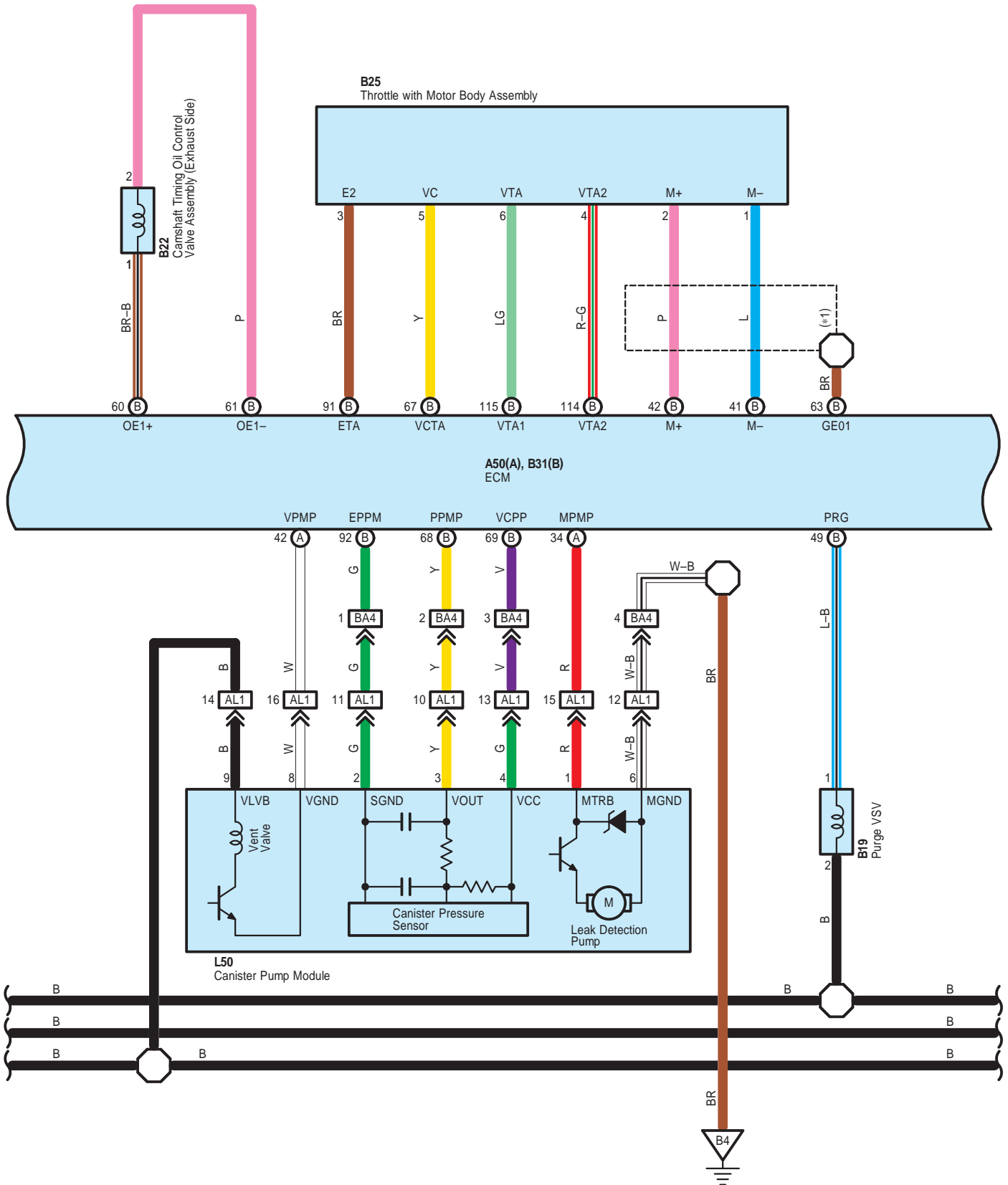

\* 1 : Shielded

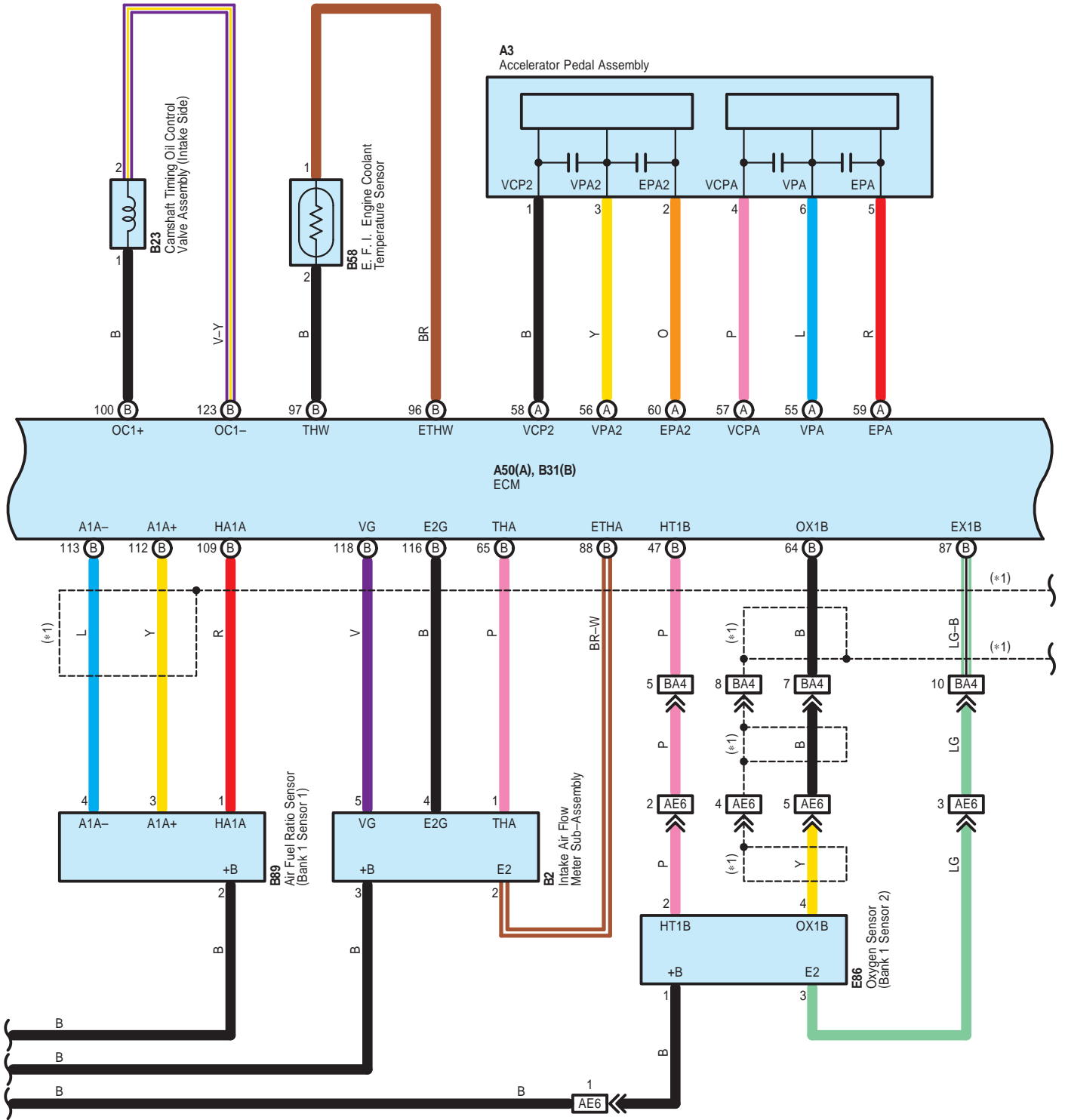

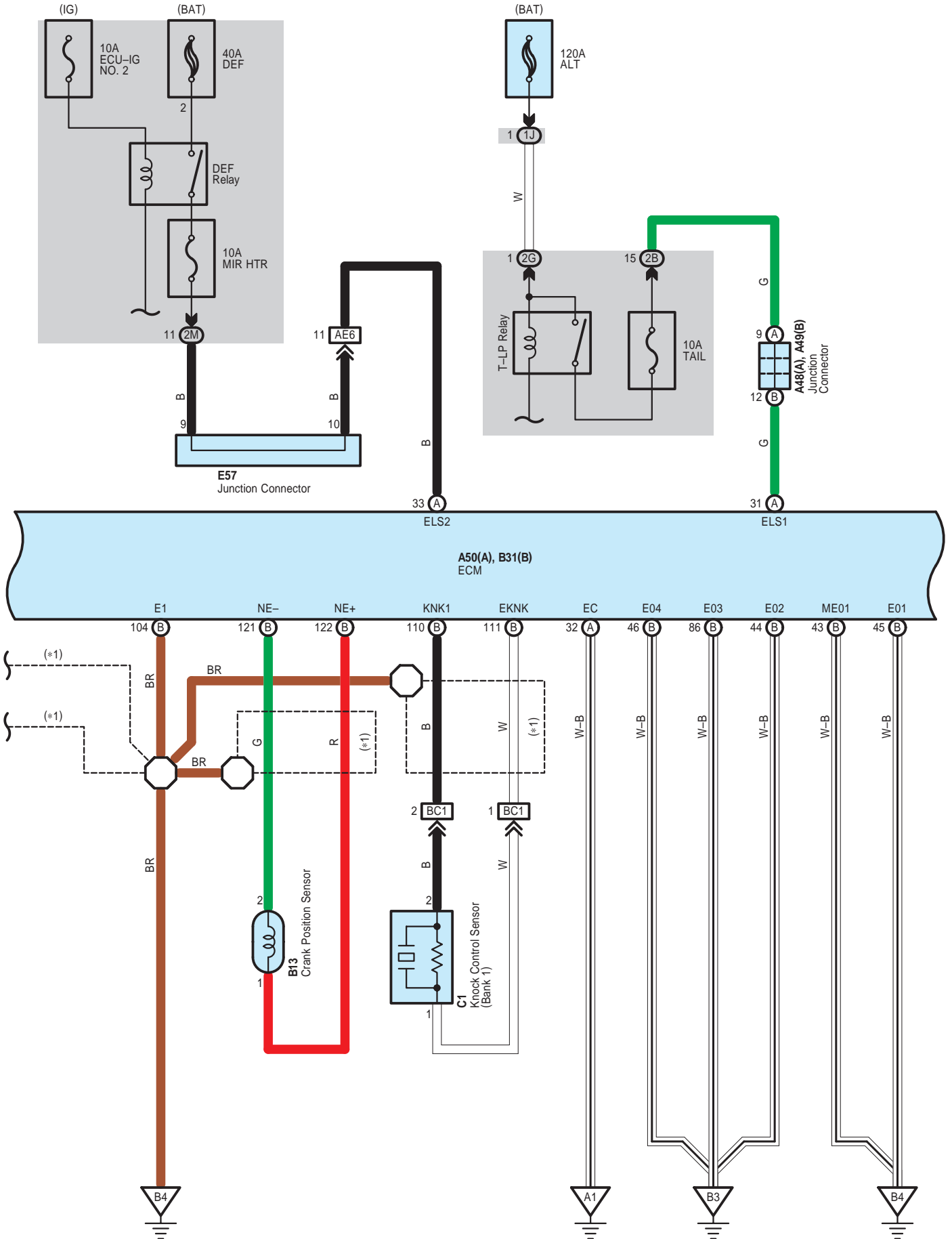

- \* 1 : Shielded
- \* 2 : w/ Smart Key System
- \* 3 : w/o Smart Key System

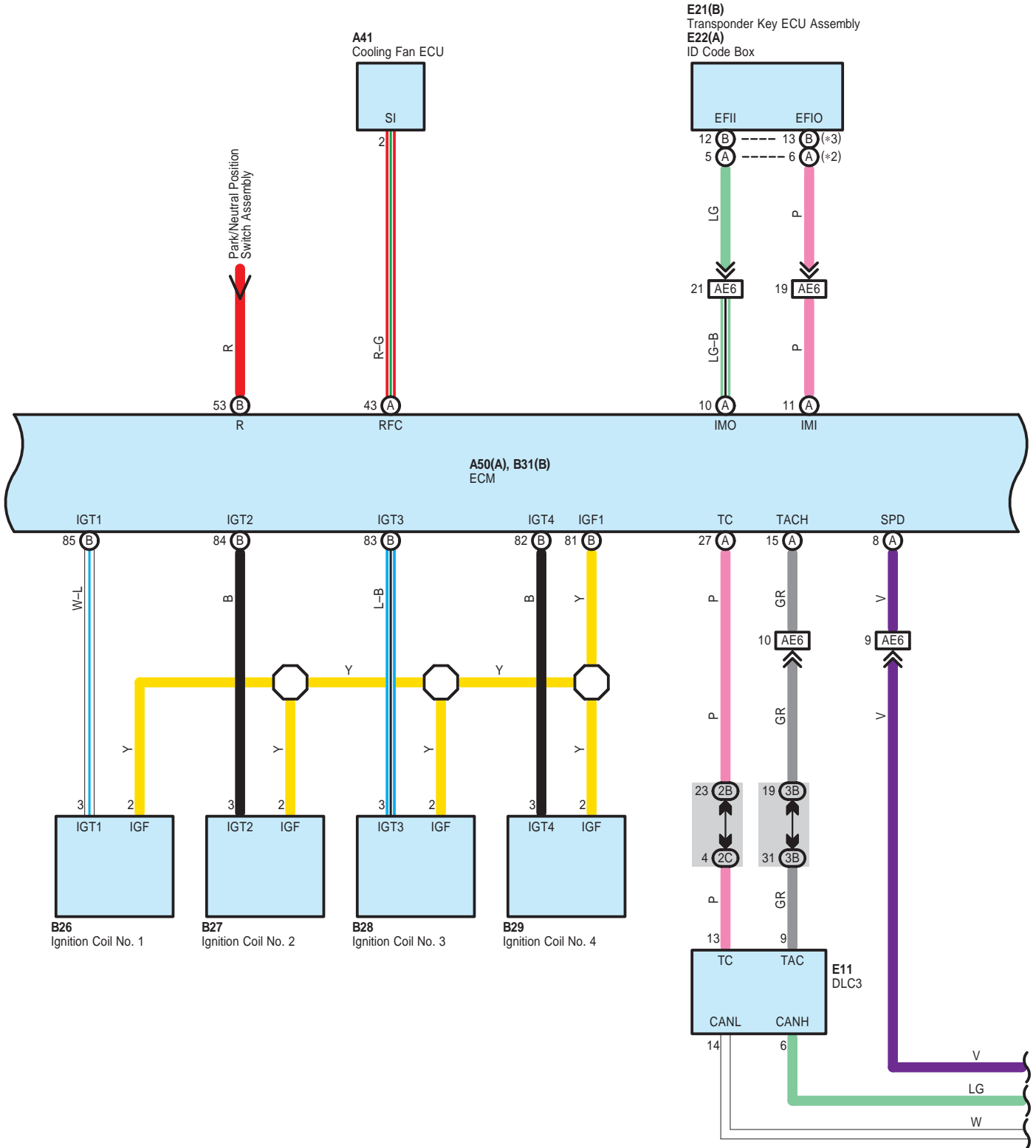

\* 2 : w/ Smart Key System  
 \* 3 : w/o Smart Key System

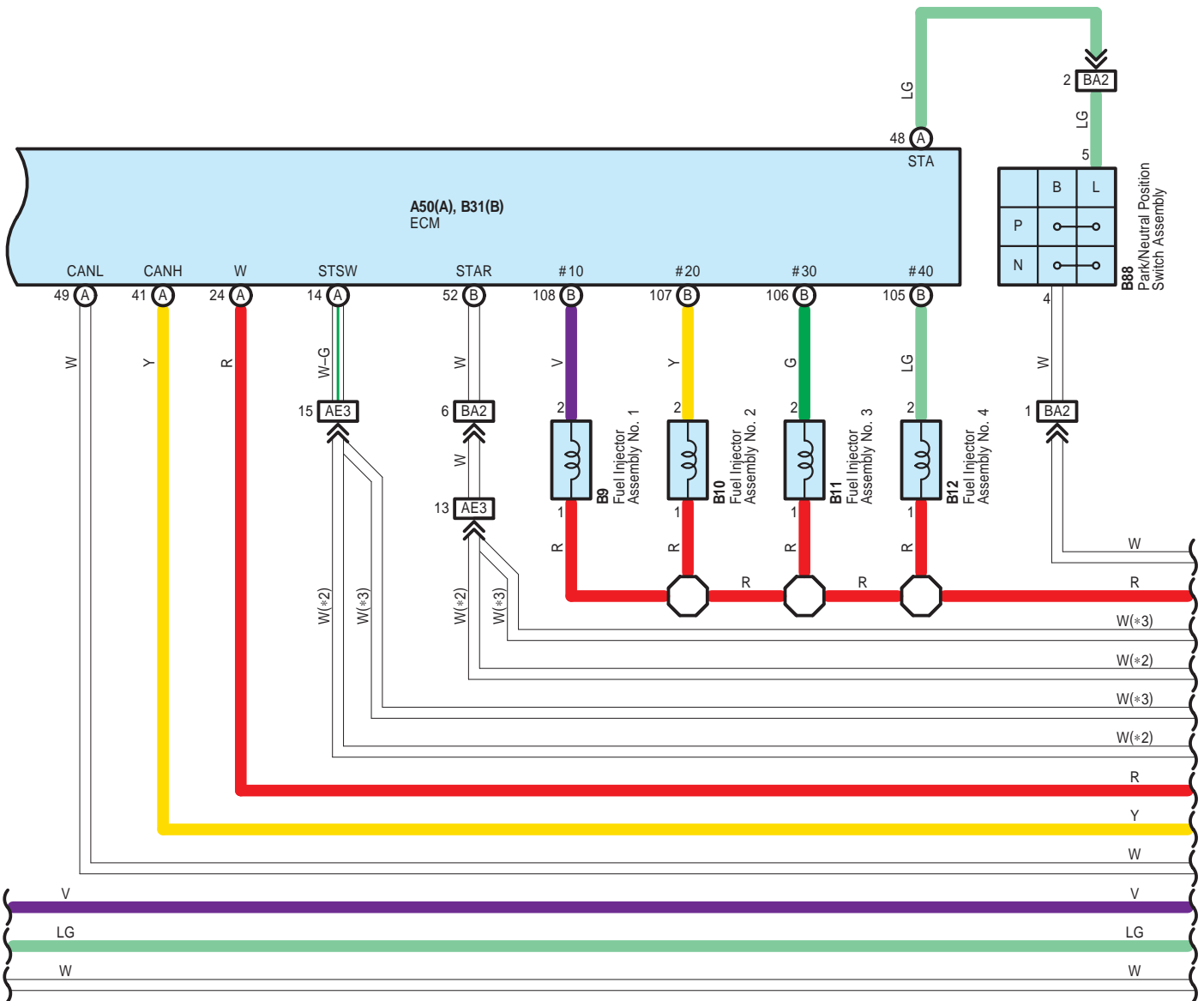



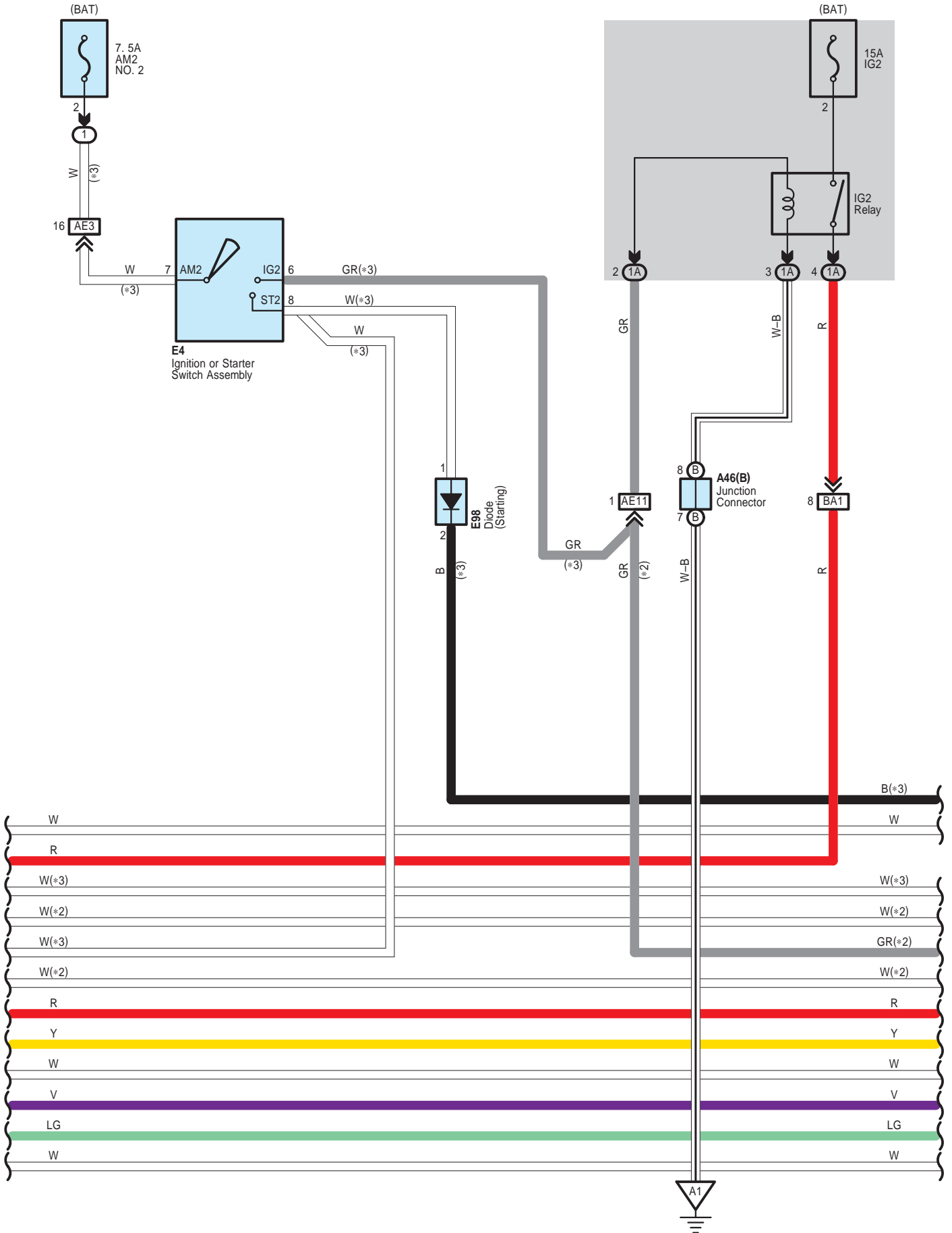

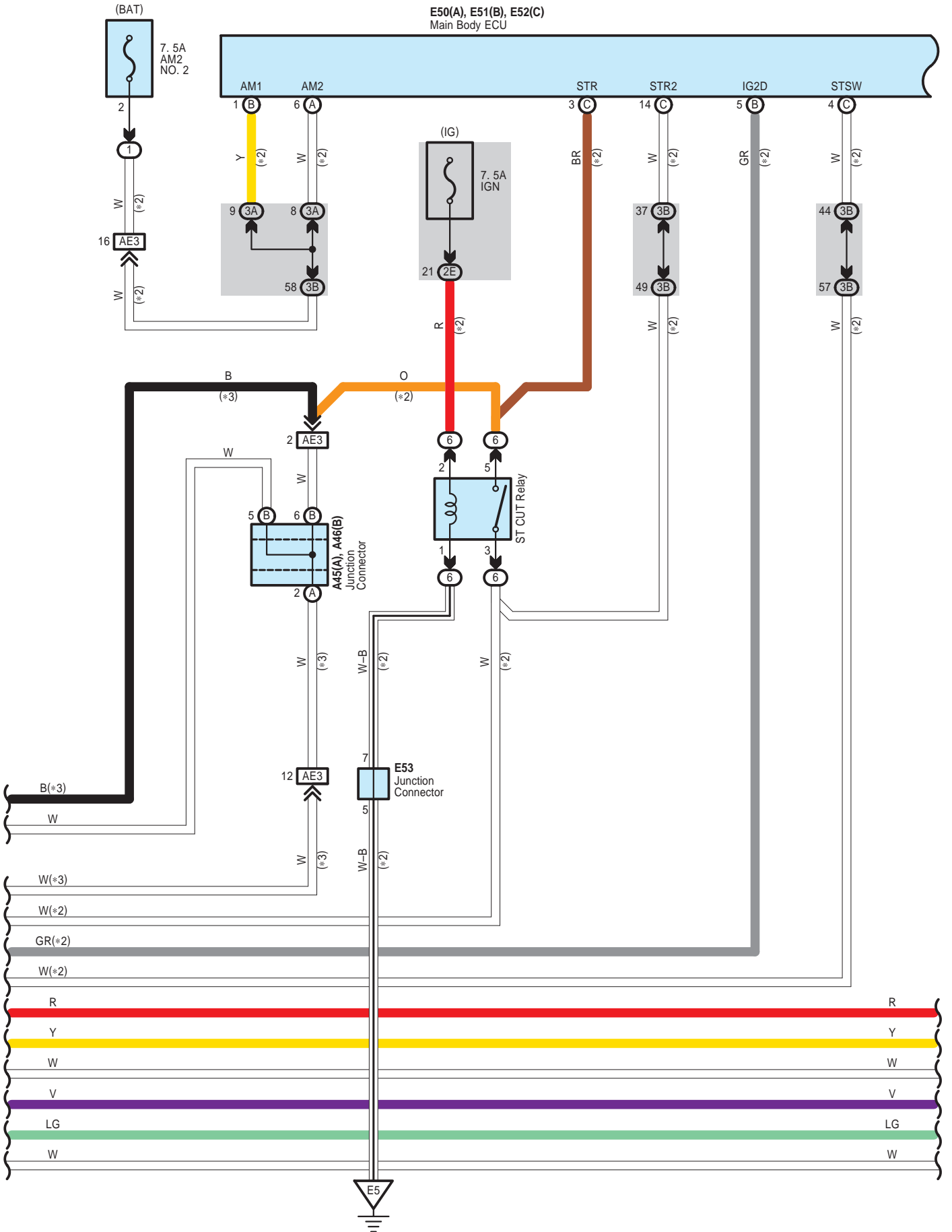

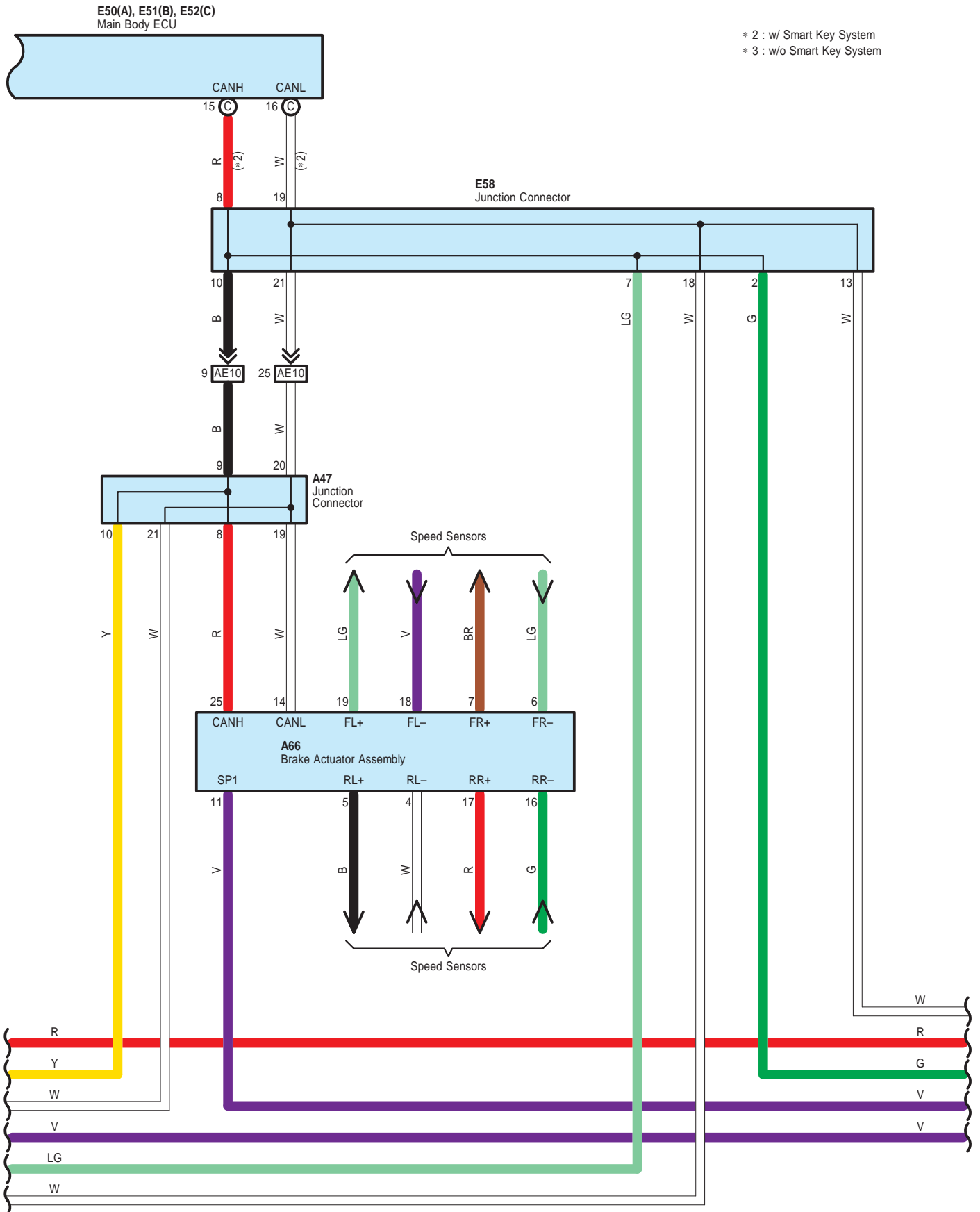

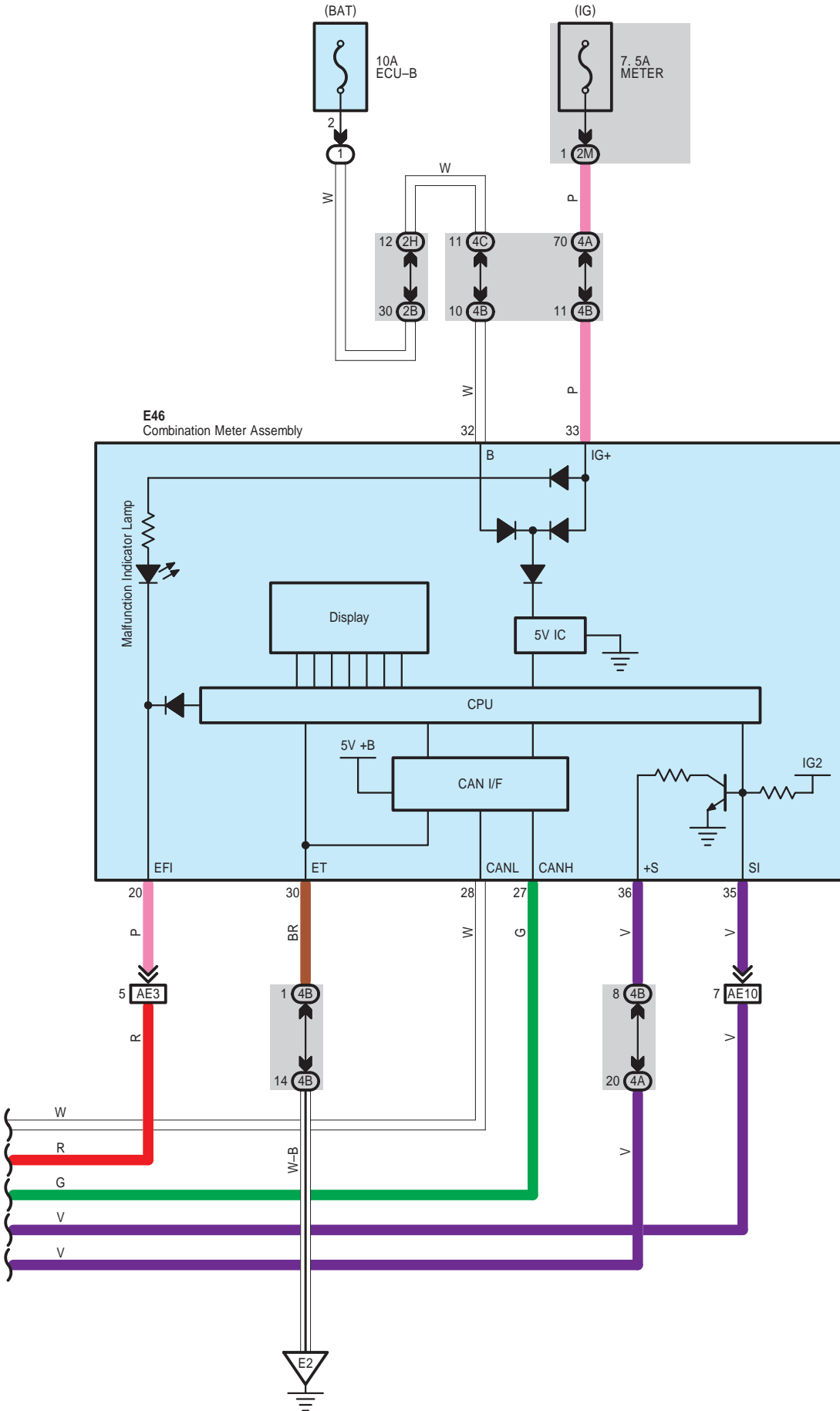

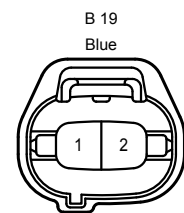
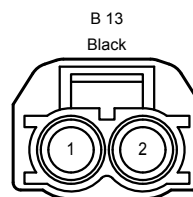
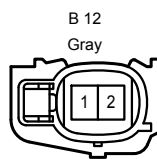
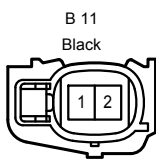
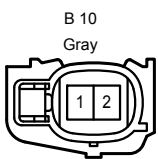
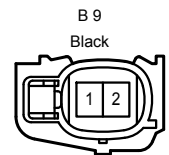
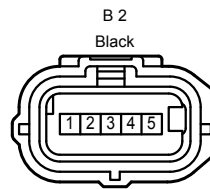
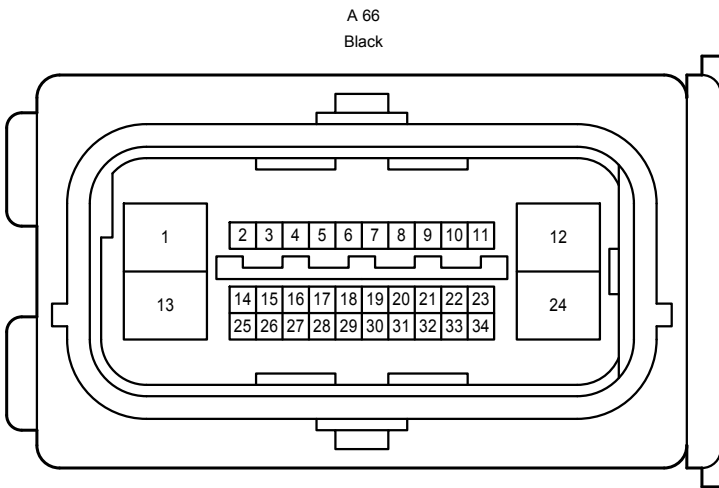
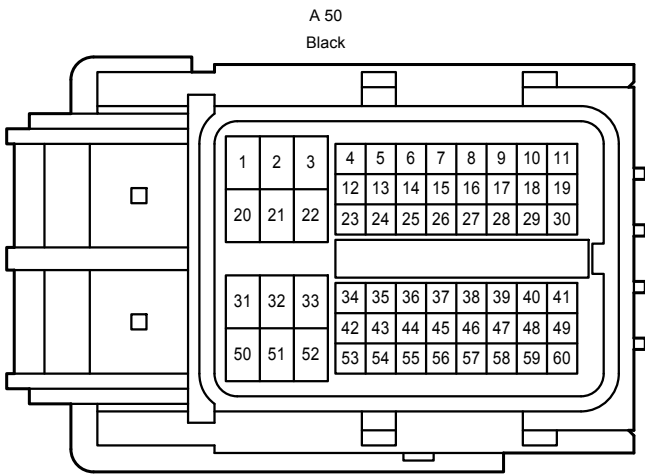
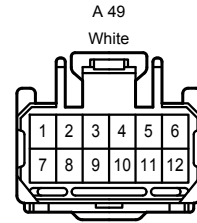
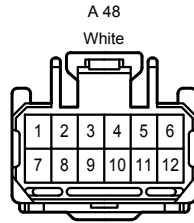
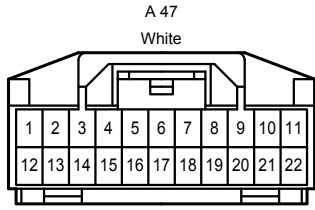
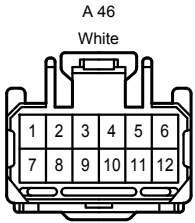
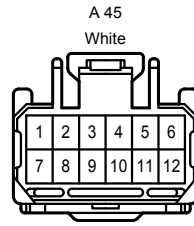
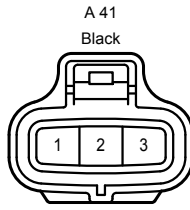
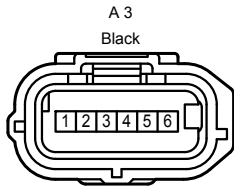
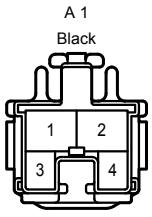



E 46  
White

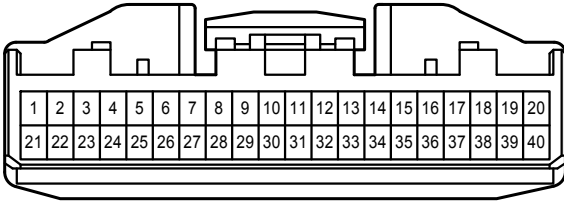

E 50  
White

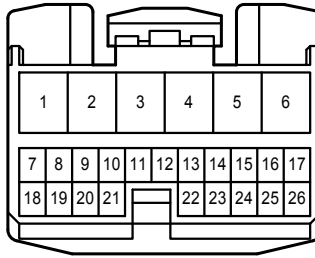

E 51  
White

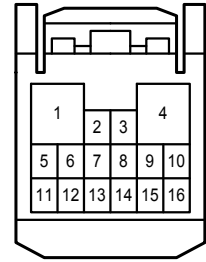

E 52  
White

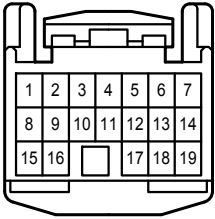

E 53  
White



E 57  
White

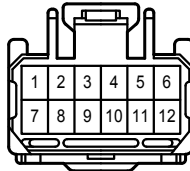

E 58  
Gray

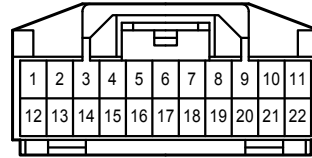

E 86  
Gray

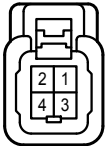

E 98  
Black



L 17  
White



L 50  
Black



1A  
White

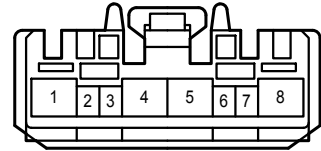

1B  
White

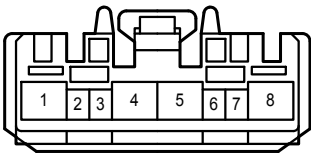

1J

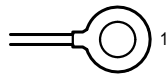

2A  
White

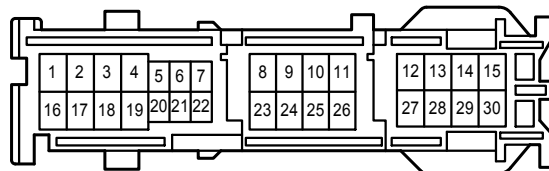

2B  
White

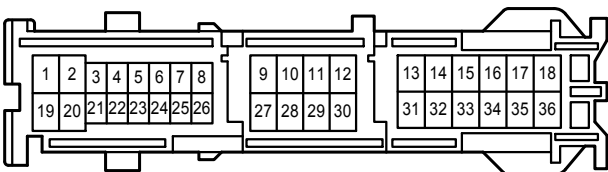

2C  
White

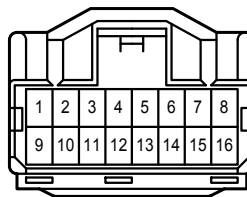

2E  
White

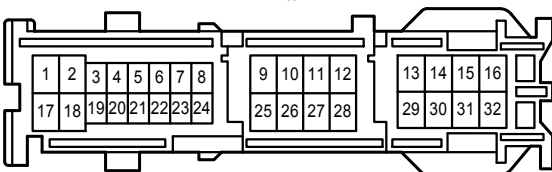

2G  
White

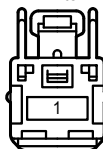

2H  
White

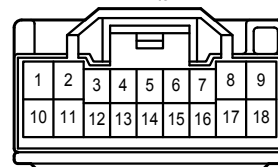

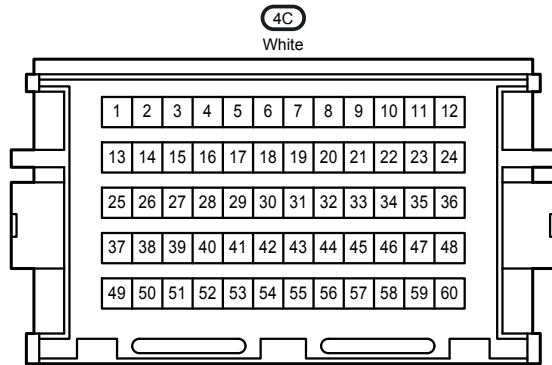
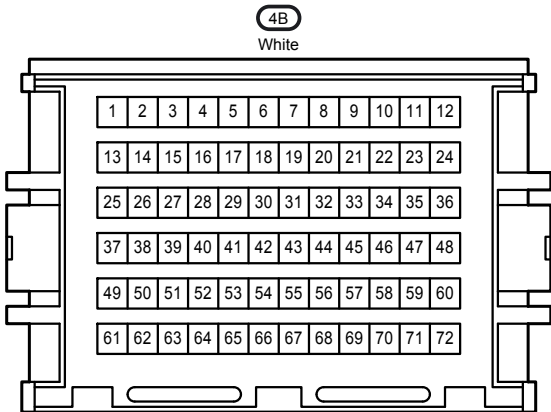
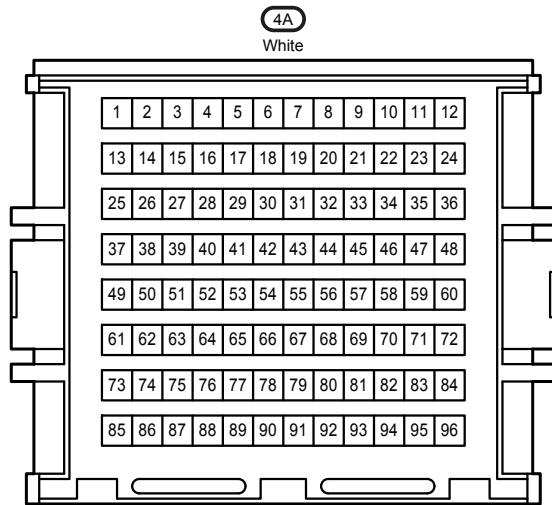
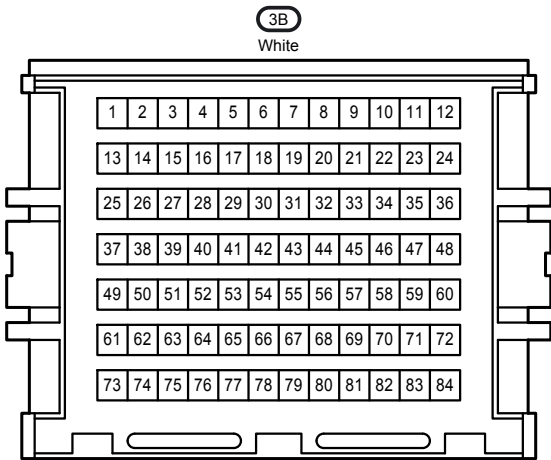
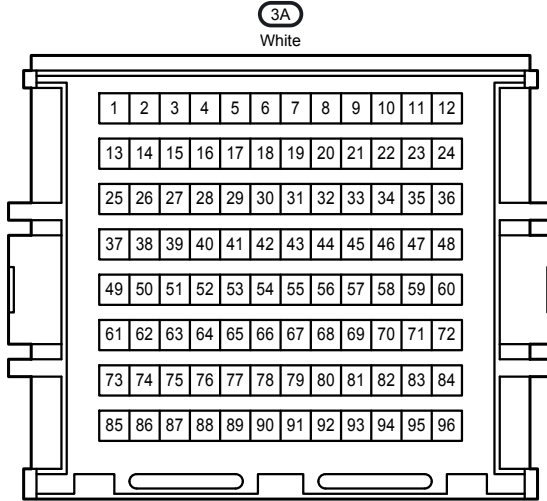
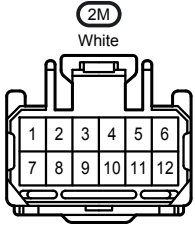



AE3  
White

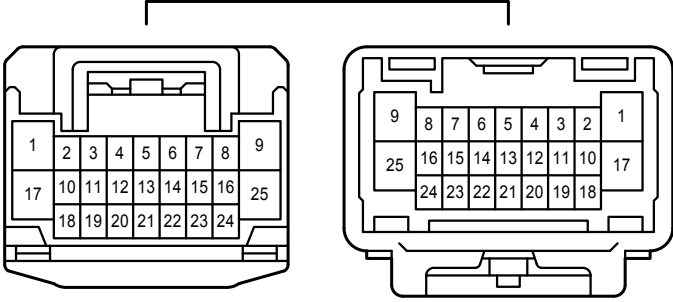

AE6  
Gray

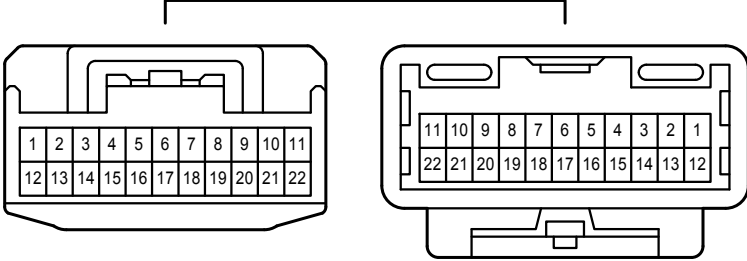

AE10  
Gray

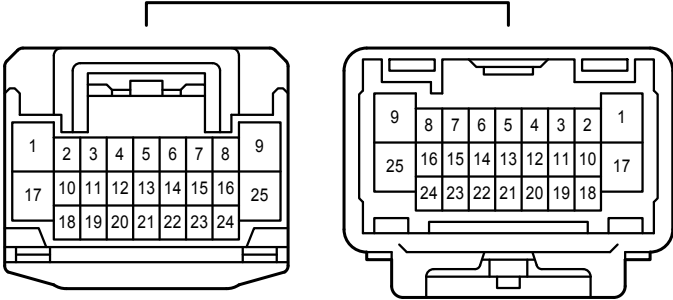

AE11  
White

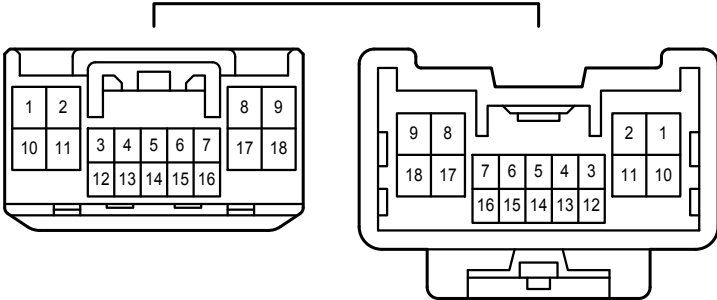

AL1  
White

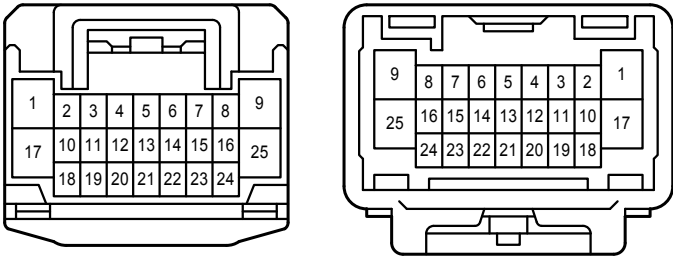

BA1  
White

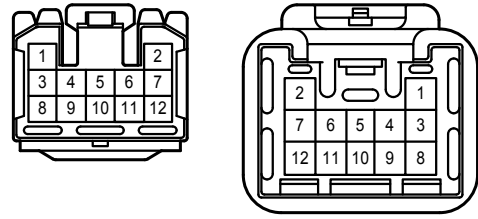

BA2  
White

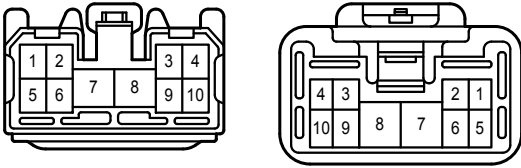

BA4  
Gray

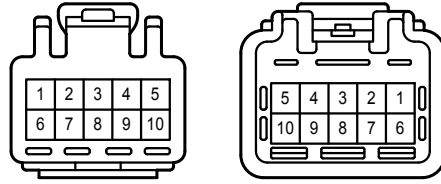

BC1  
Gray

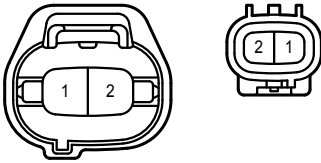

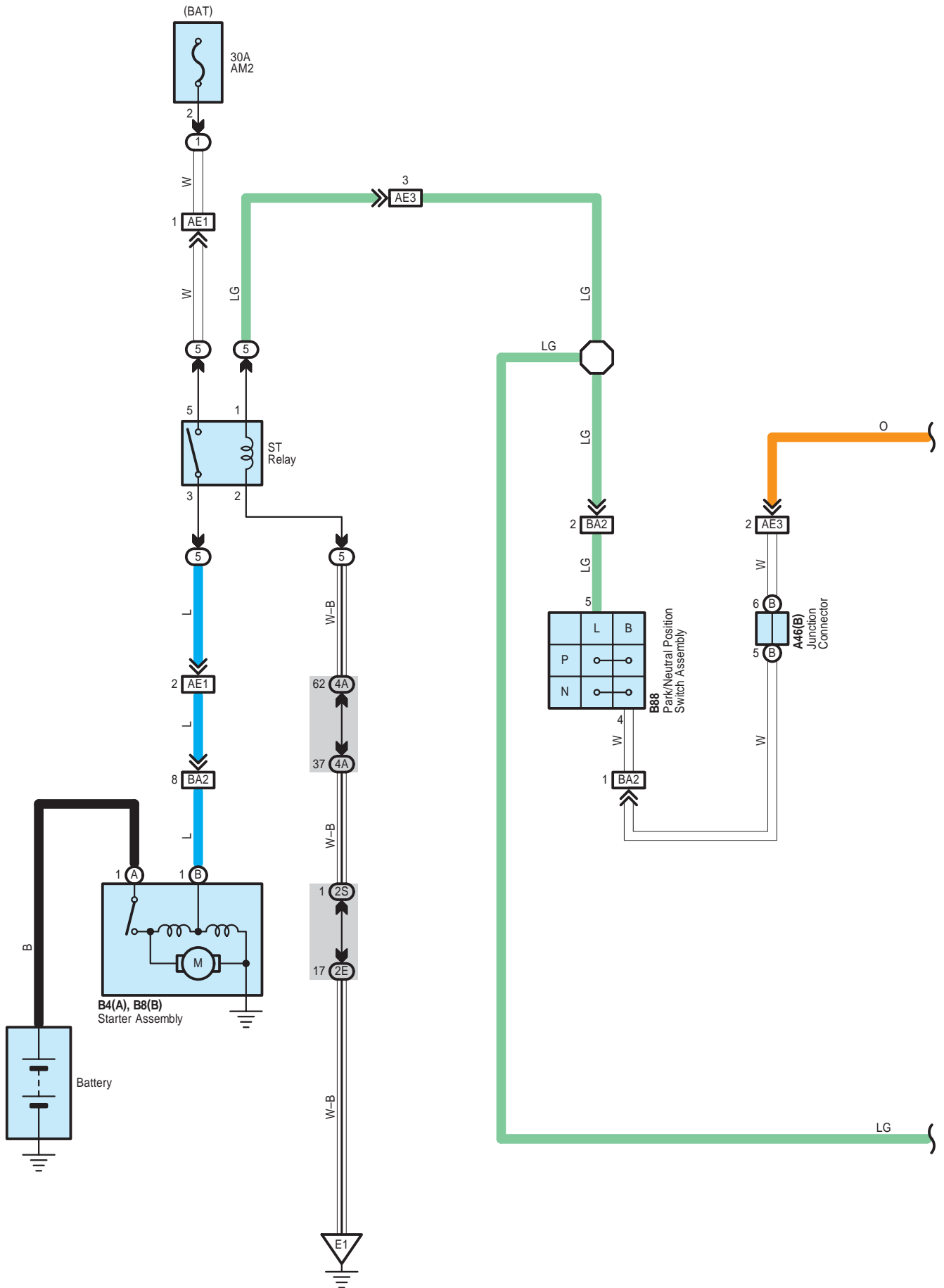

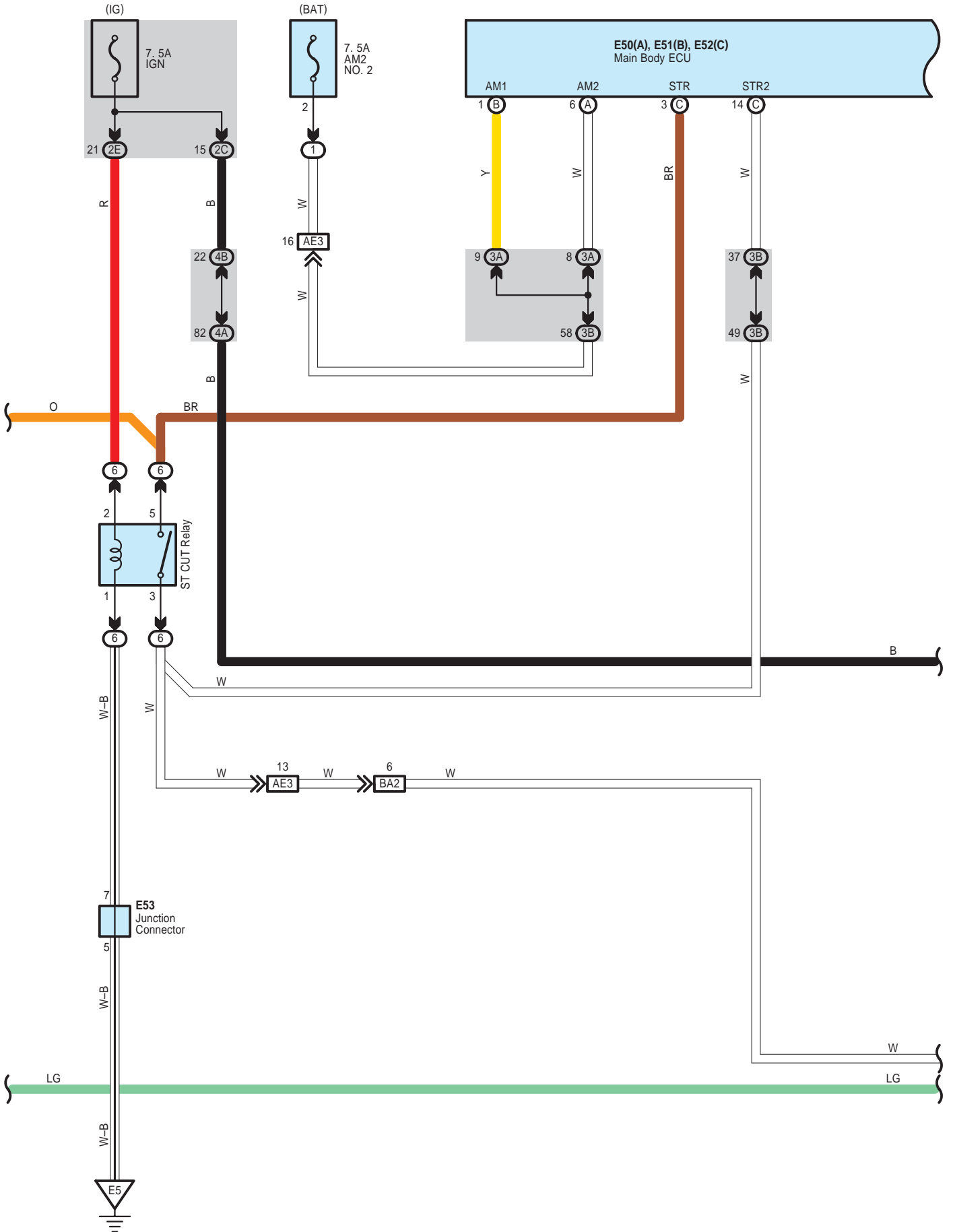

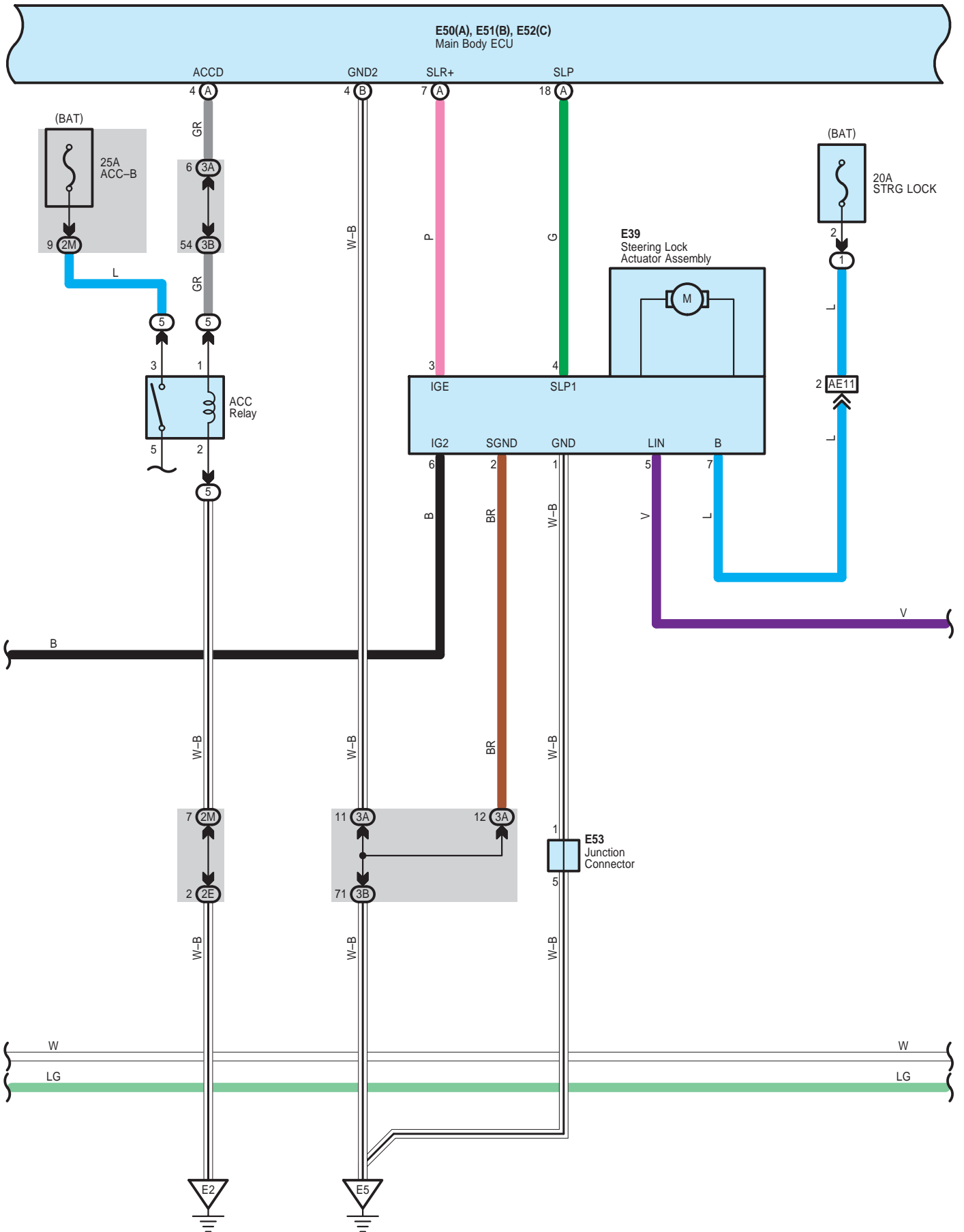

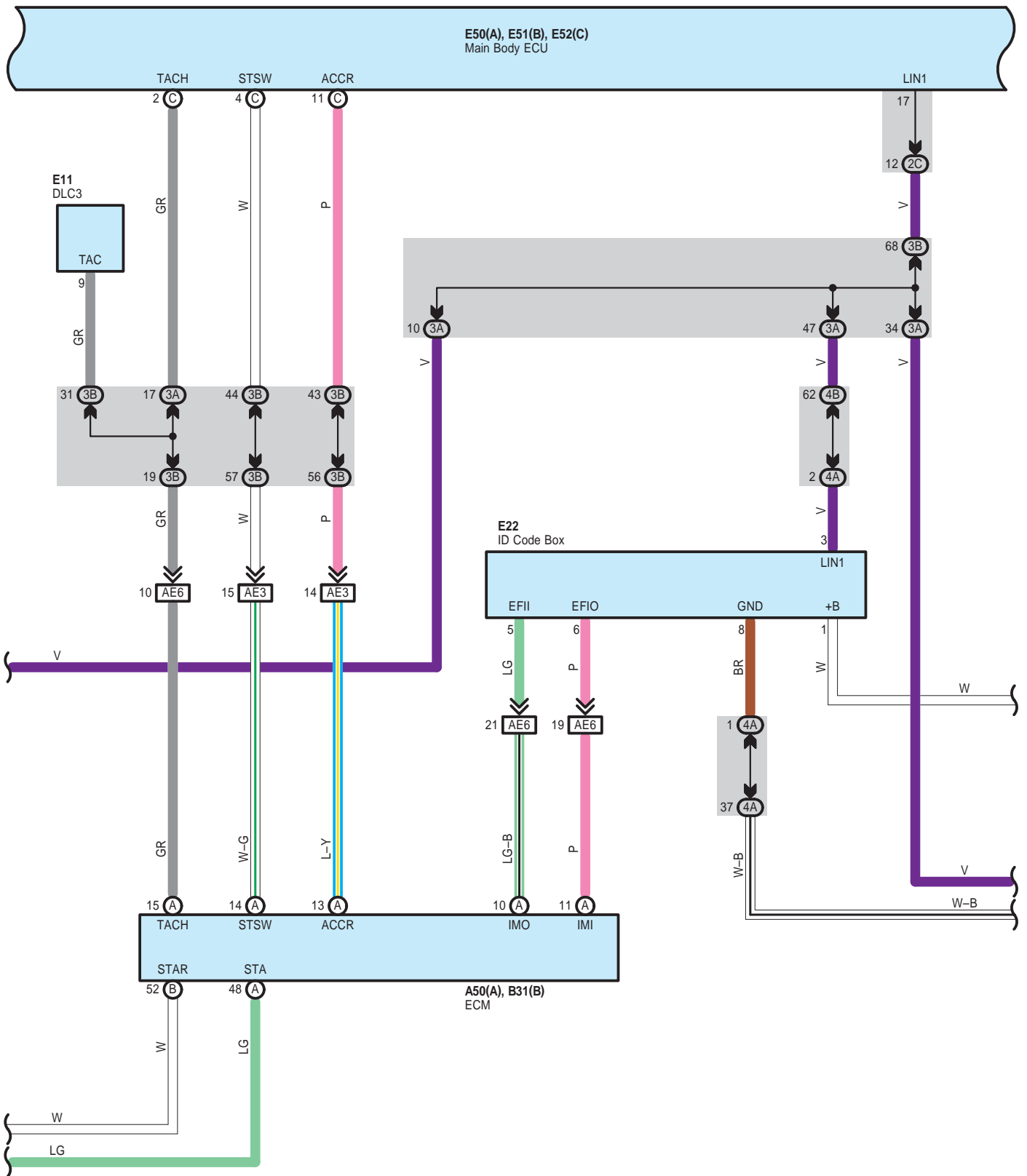

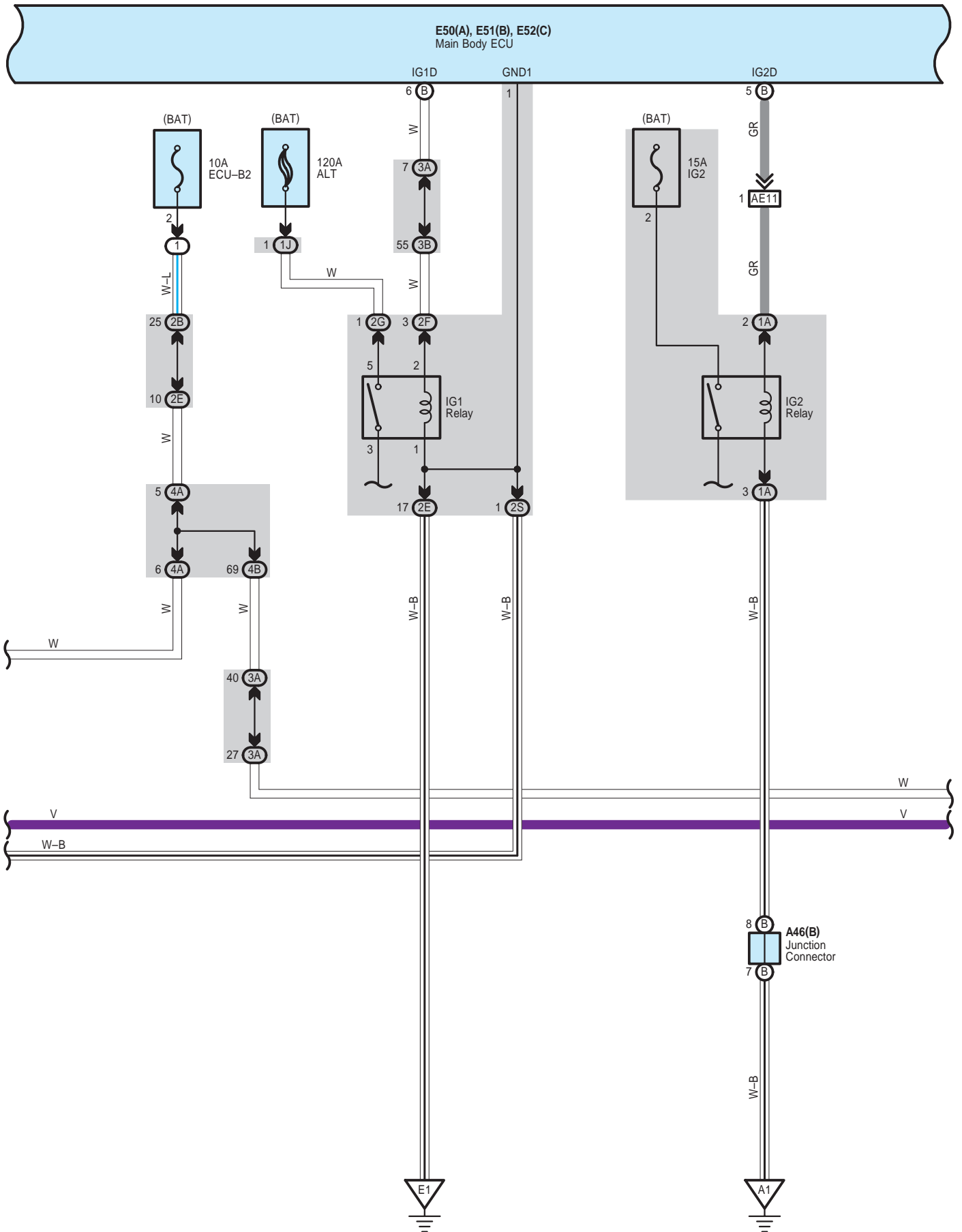

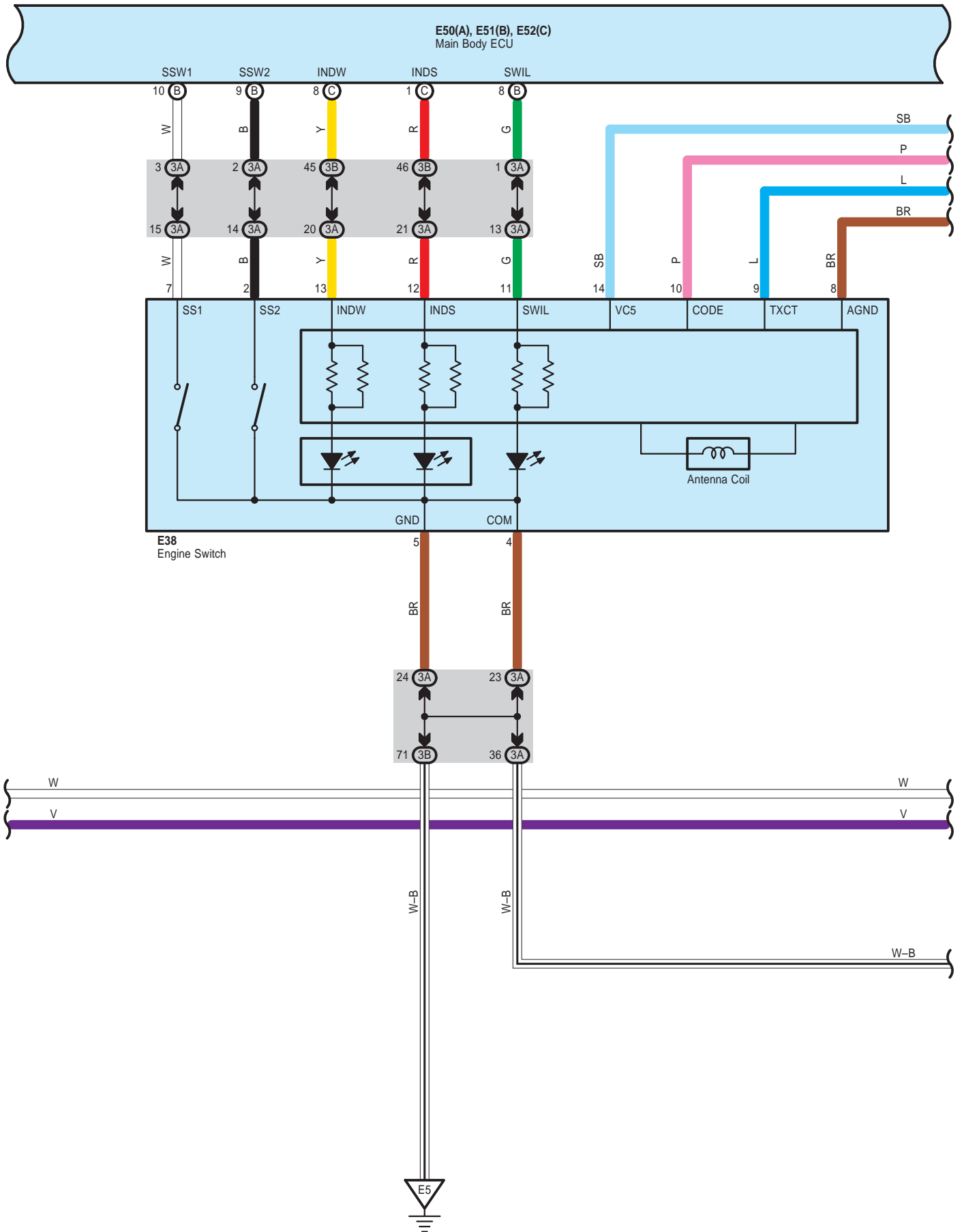



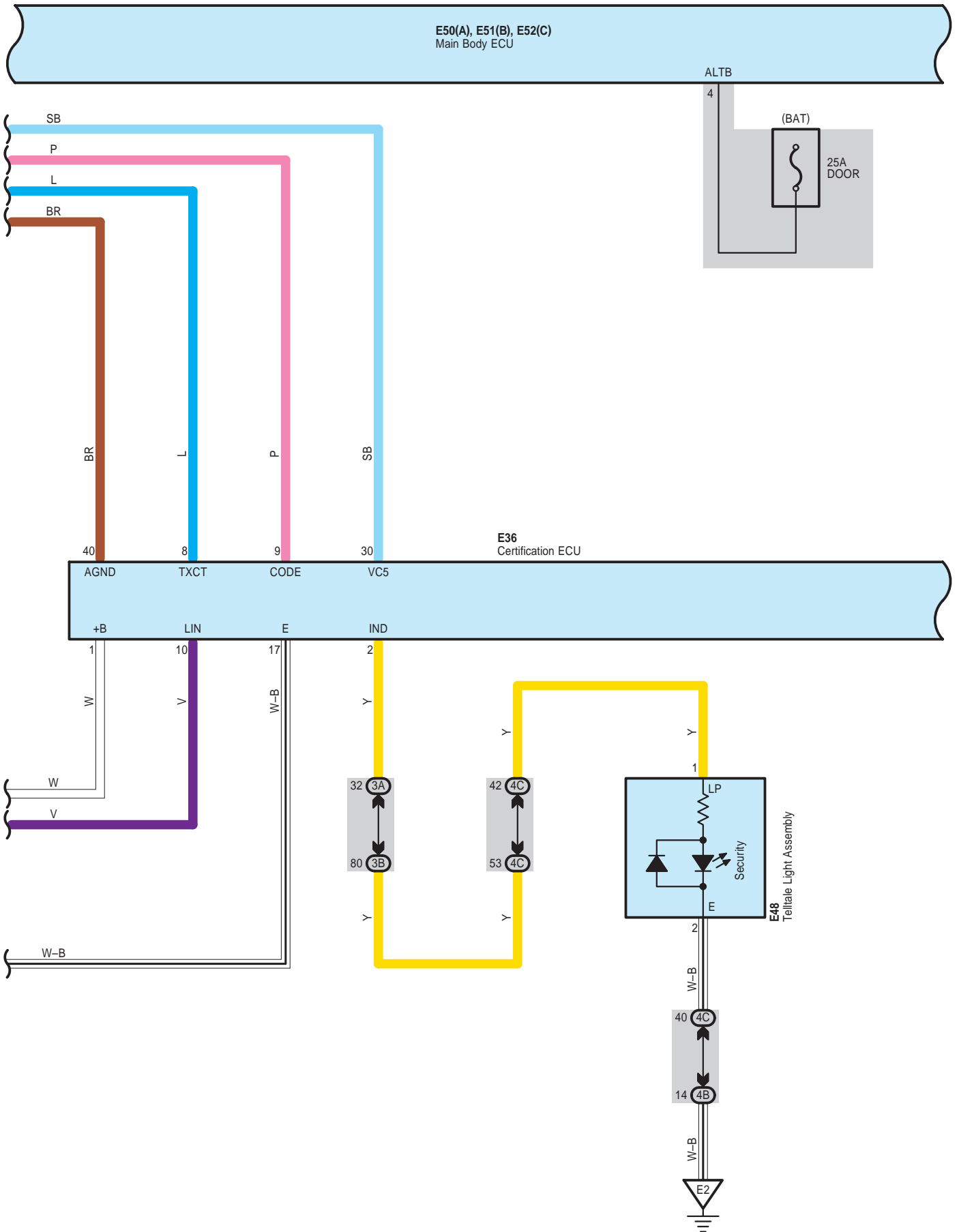

E50(A), E51(B), E52(C)  
Main Body ECU

# : There is no wire color information

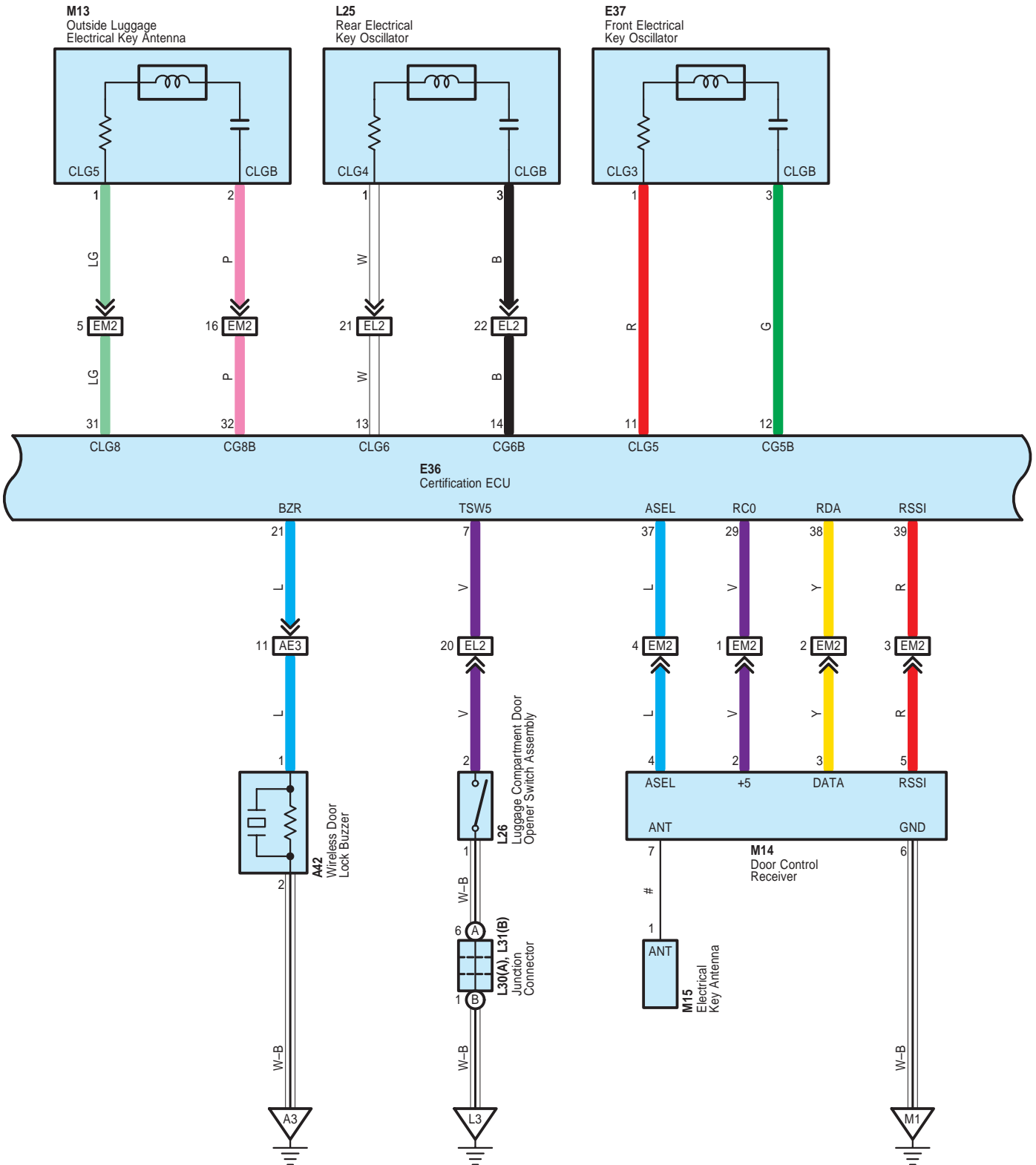

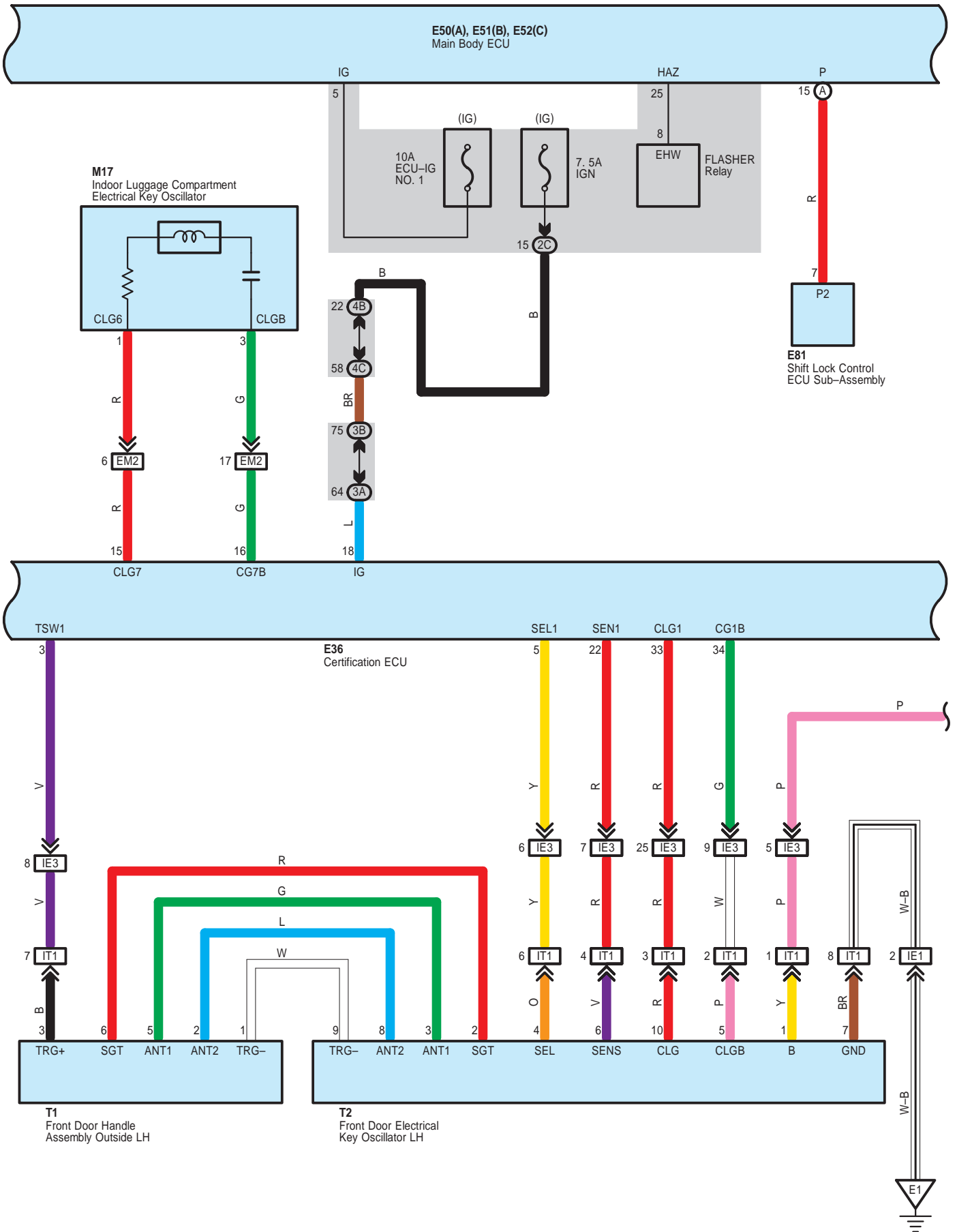

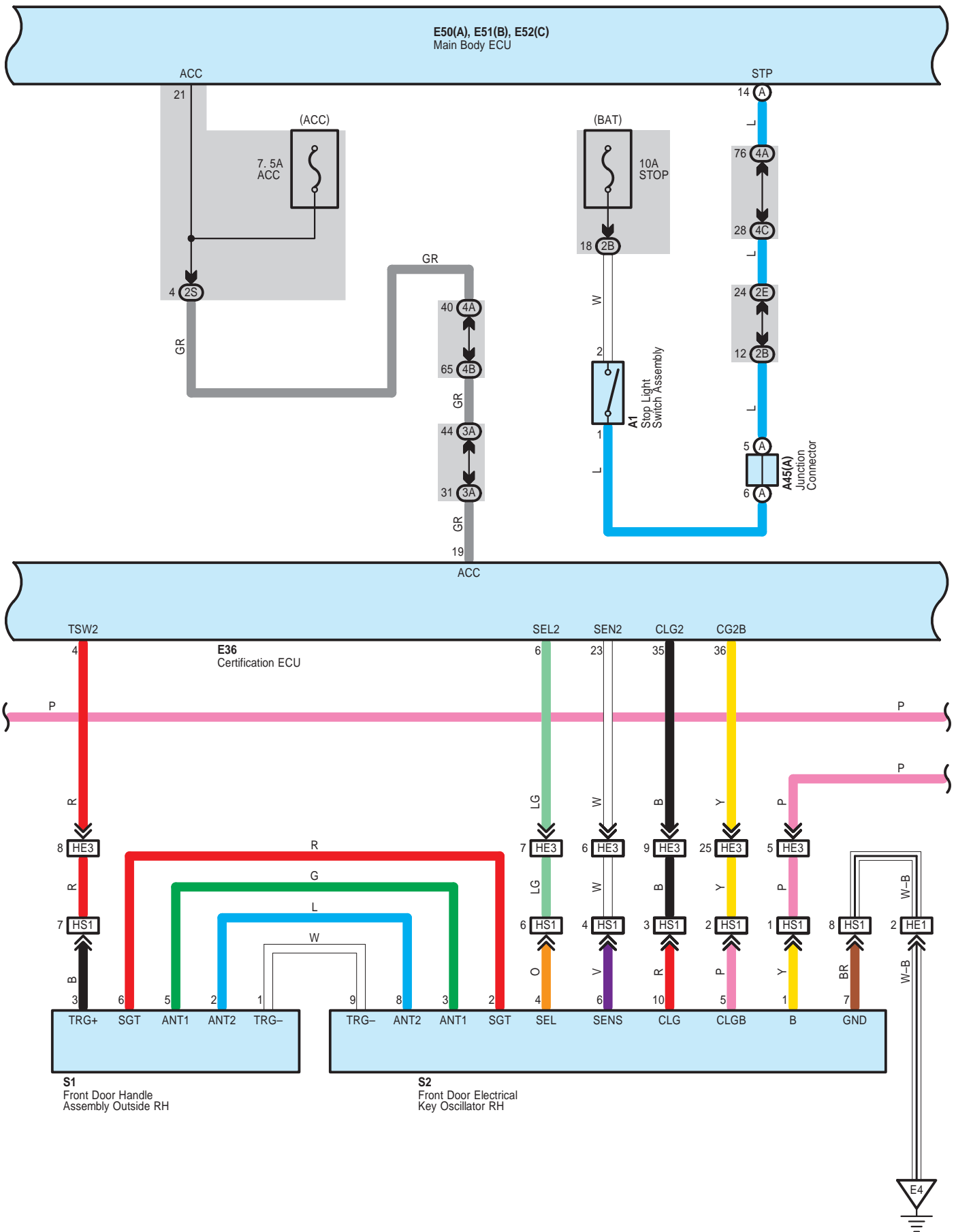

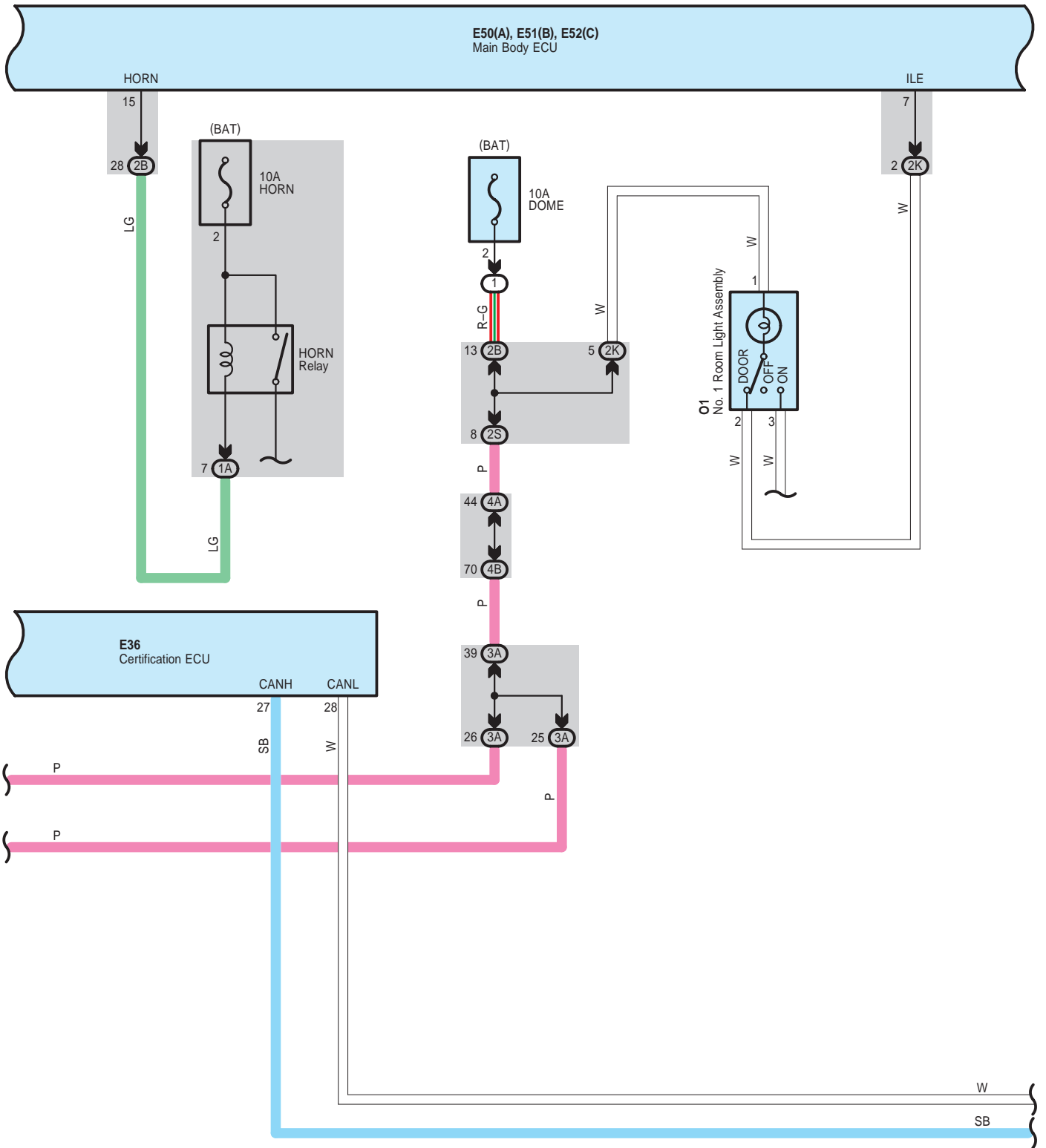

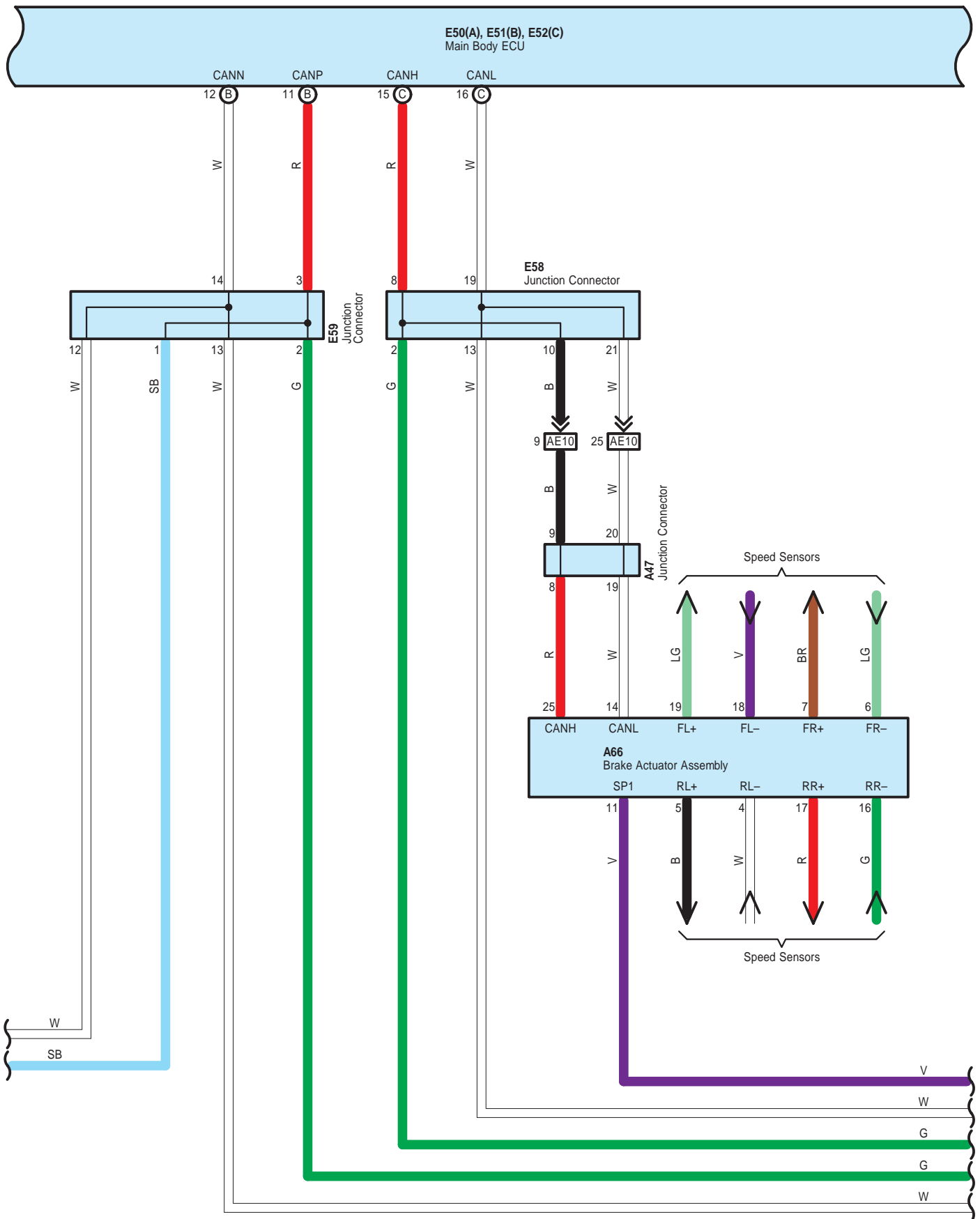

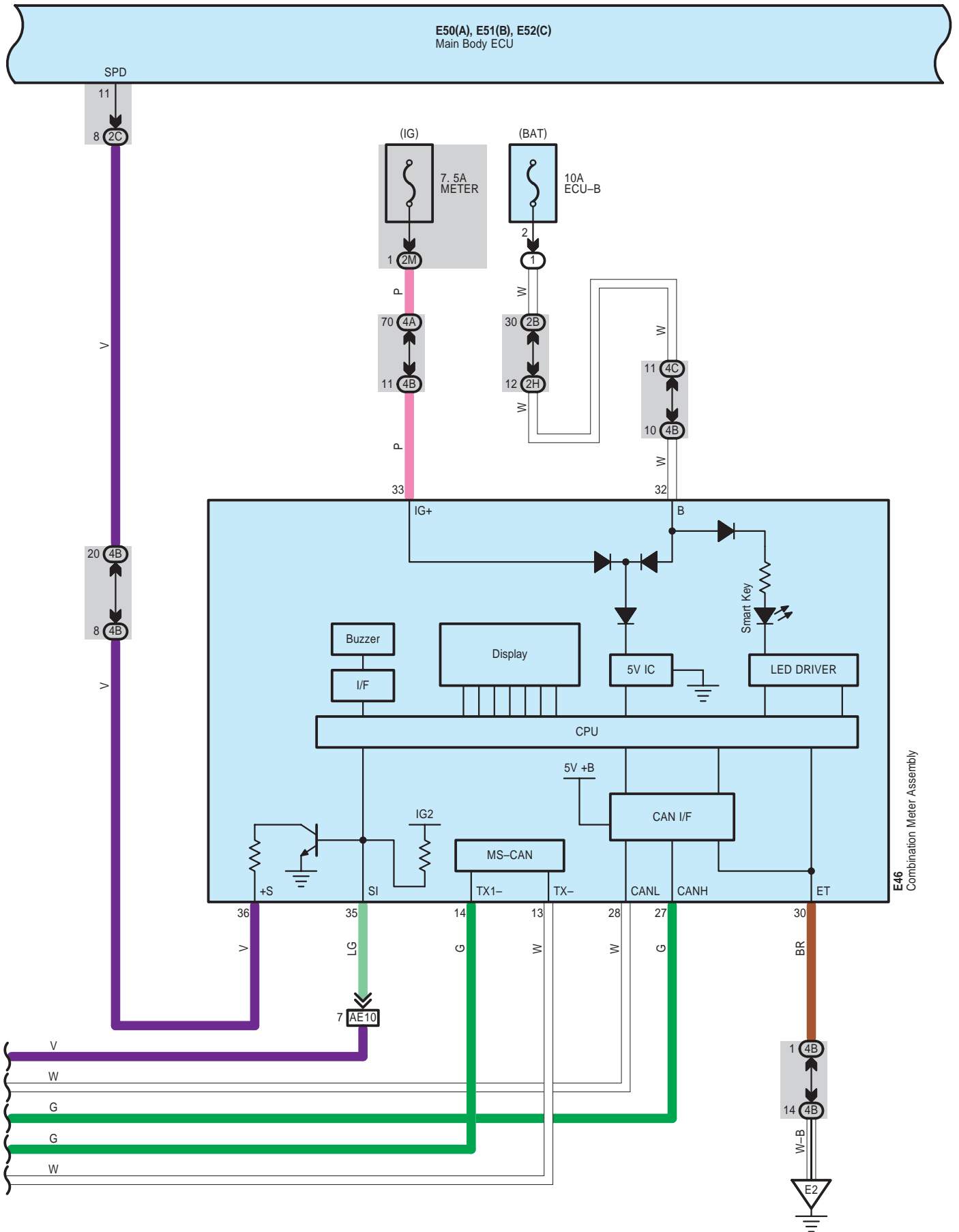

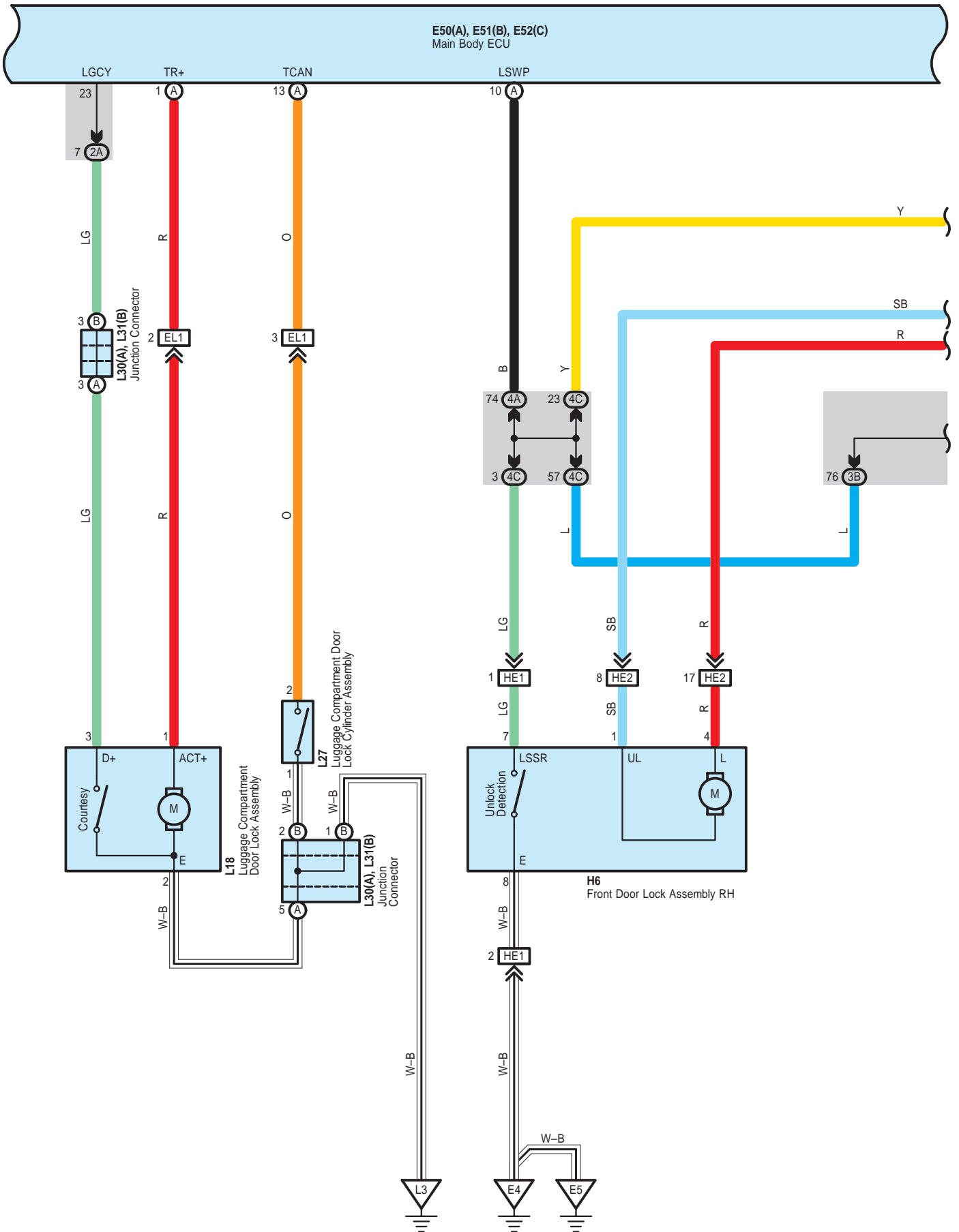



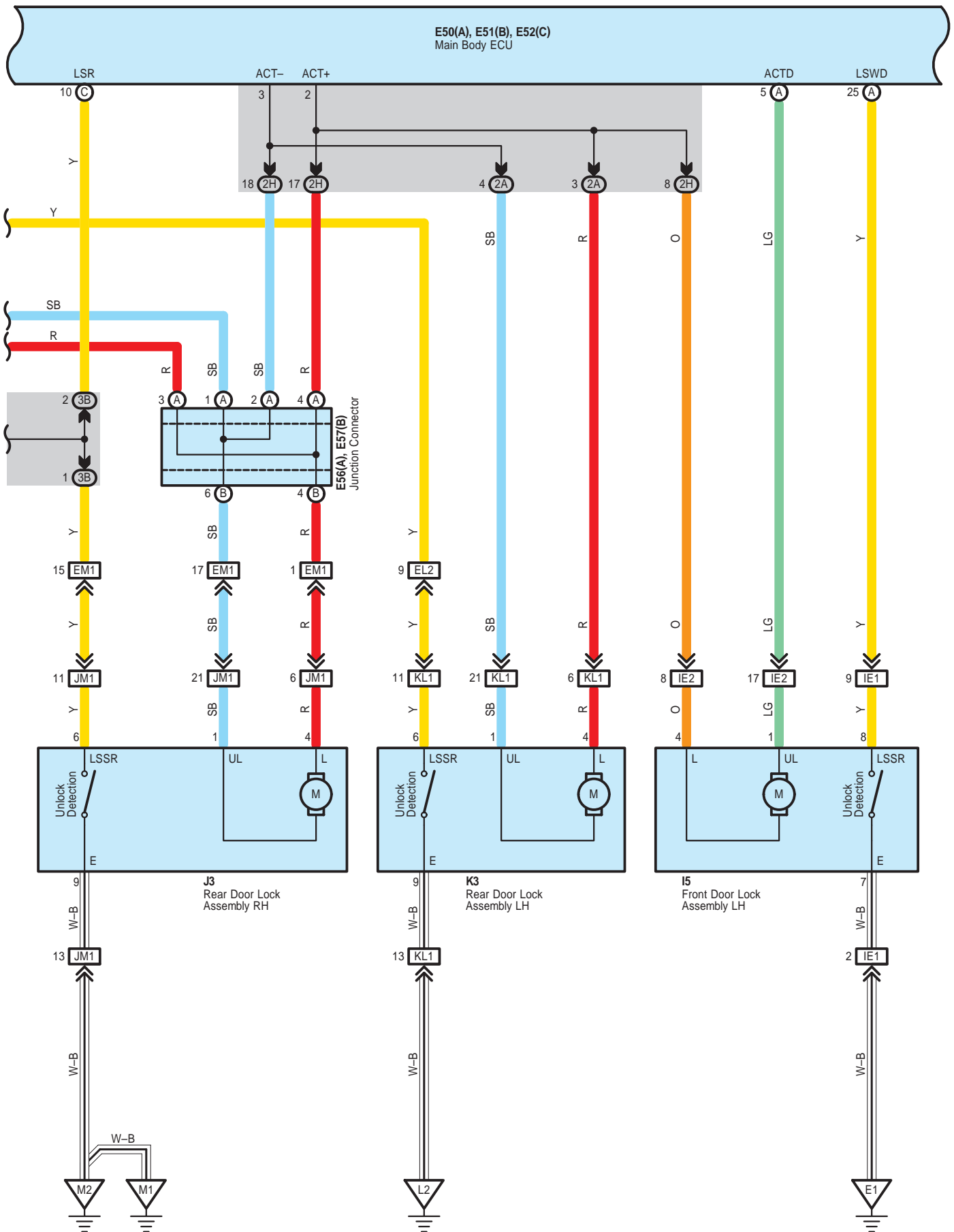

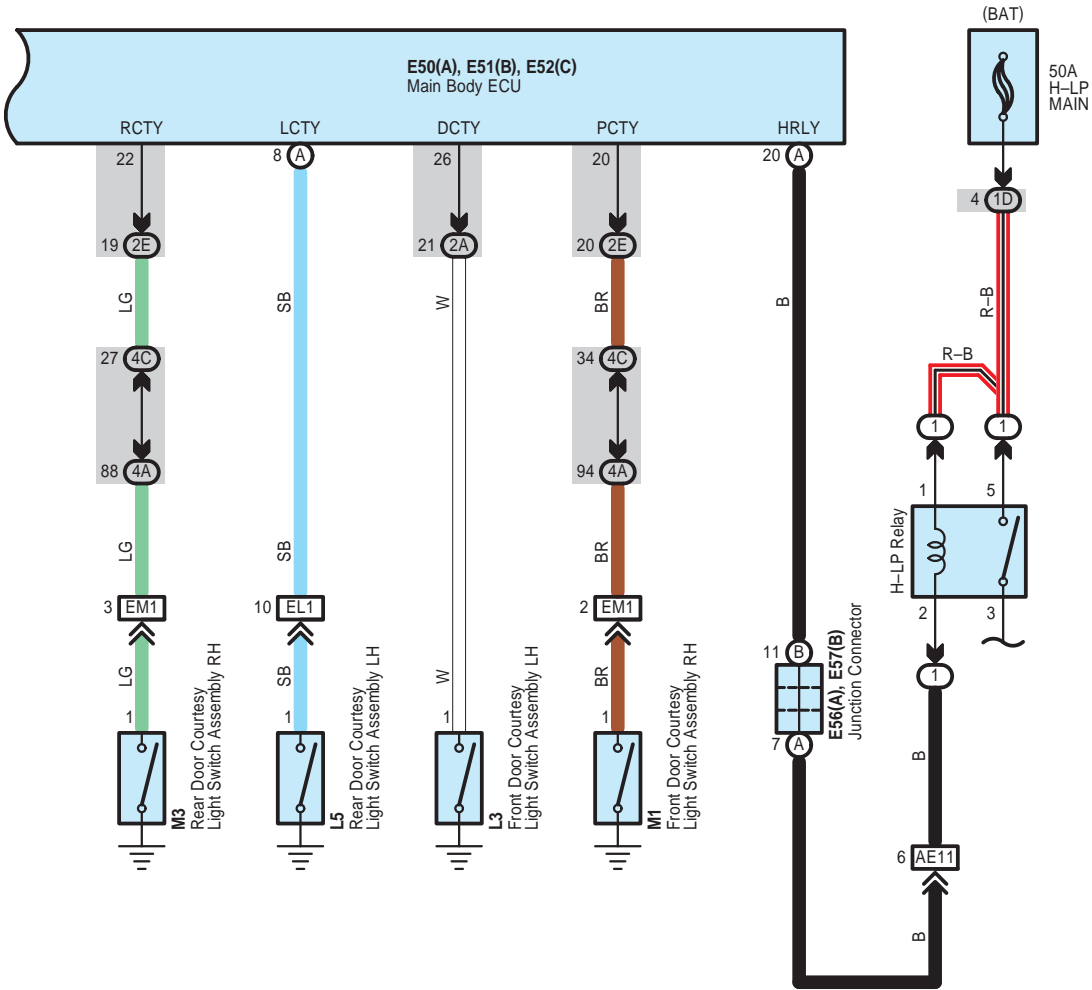

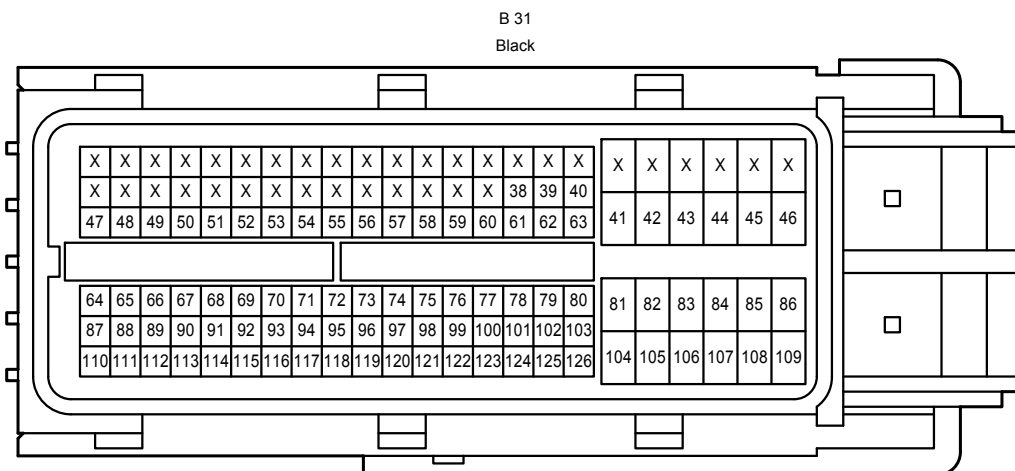
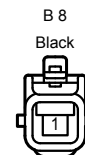
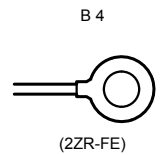
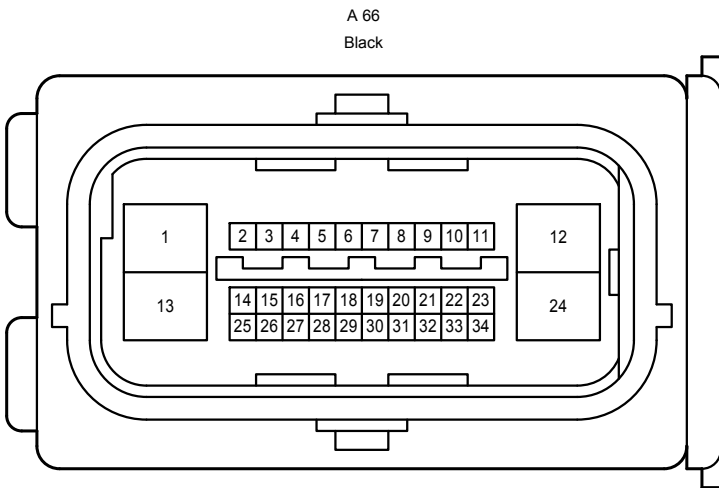
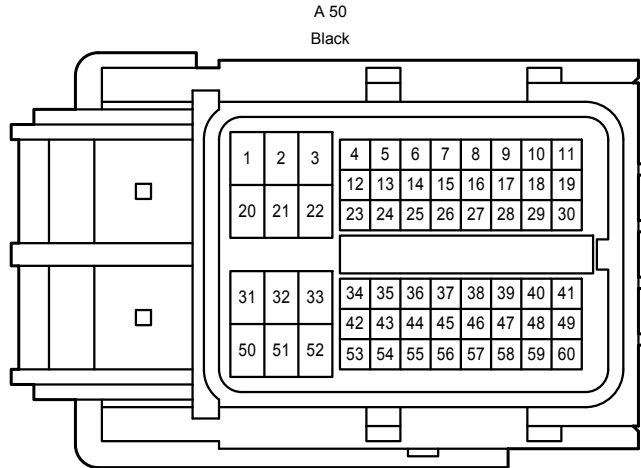
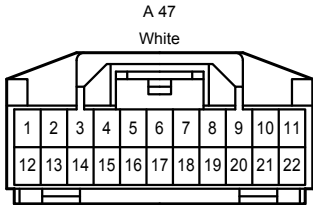
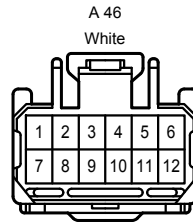
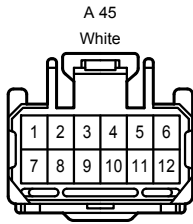
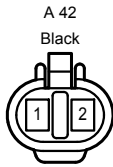
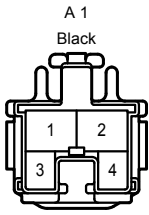

B 88  
Gray

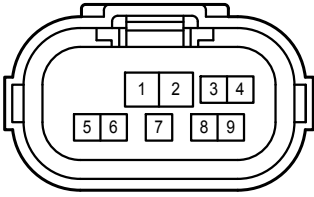

E 11  
White

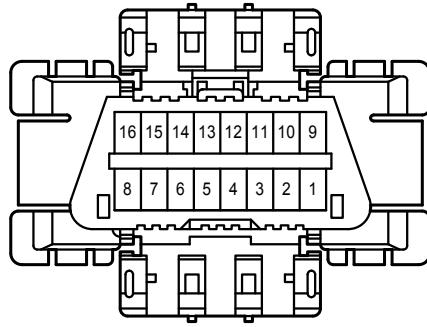

E 22  
White

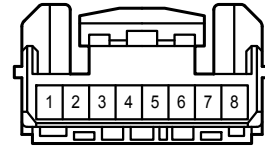

E 36  
White

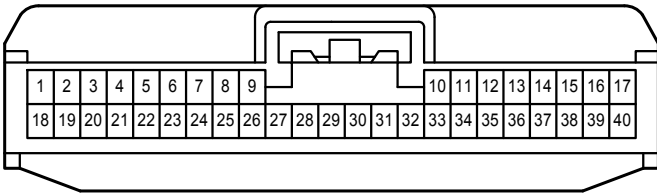

E 37  
White

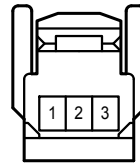

E 38  
Black

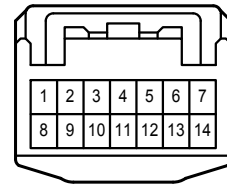

E 39  
Black

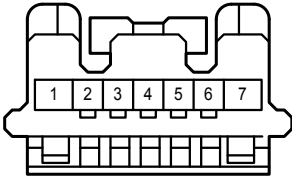

E 46  
White

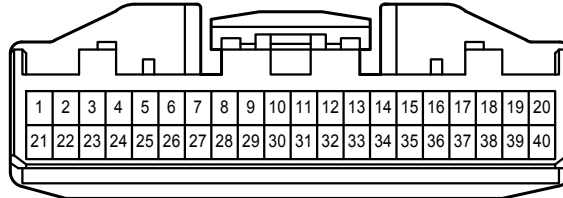

E 48  
Black

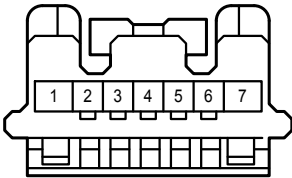

E 50  
White

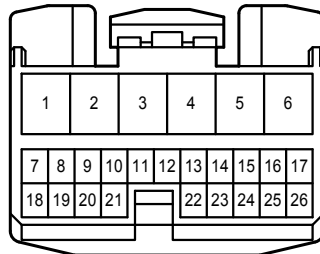

E 51  
White

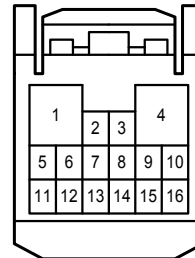

E 52  
White

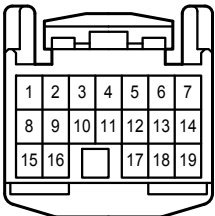

E 53  
White



E 56  
White

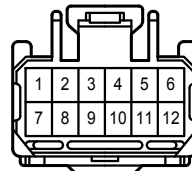

E 57  
White

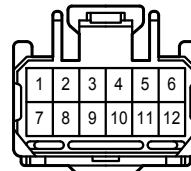

E 58  
Gray

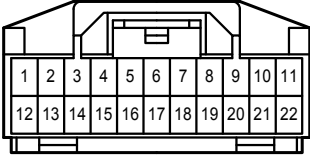

E 59  
White

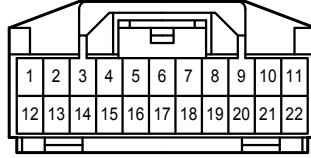

E 81  
White

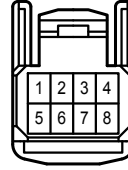

H 6  
White

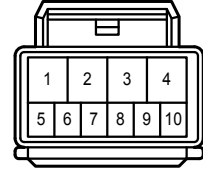

I 5  
White

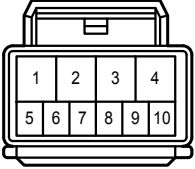

J 3  
White

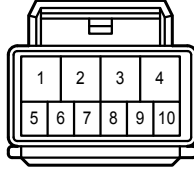

K 3  
White

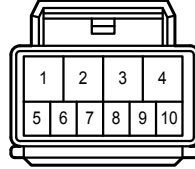

L 3  
Black



L 5  
Black



L 18  
Black

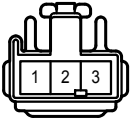

L 25  
White

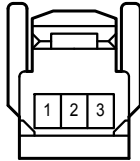

L 26  
White

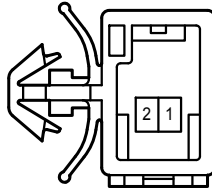

L 27  
Gray

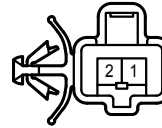

L 30  
White

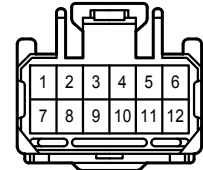

L 31  
White

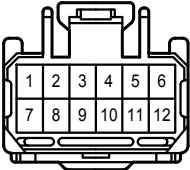

M 1  
Black



M 3  
Black



M 13  
White



M 14  
White

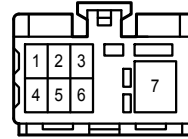

M 15  
Gray



M 17  
White

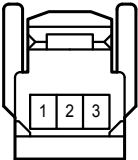

O 1  
Gray

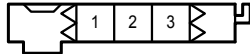

S 1  
White

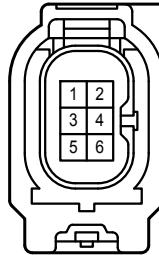

S 2  
Black

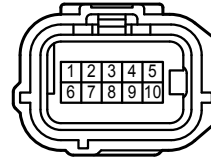

T 1  
White

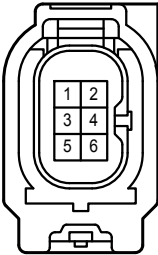

T 2  
Black



1A  
White

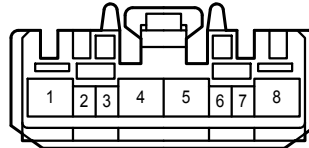

1D  
White

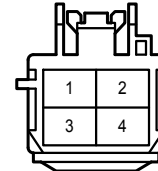

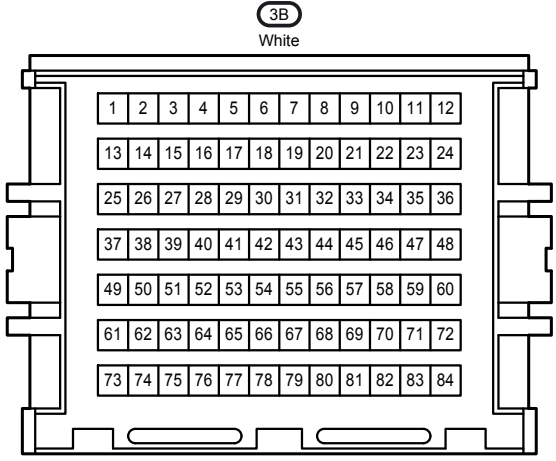
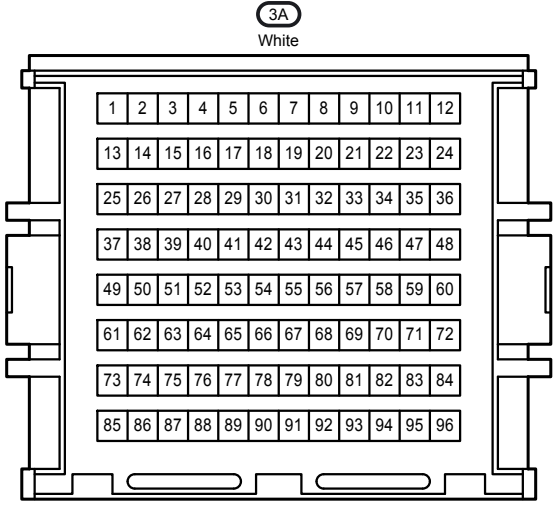
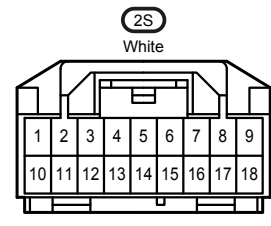
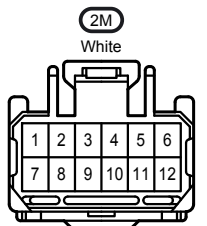
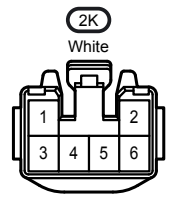
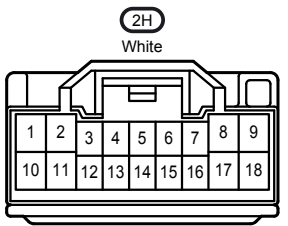
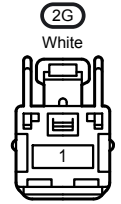
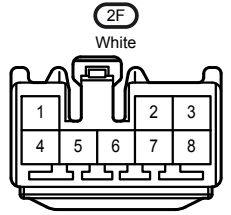
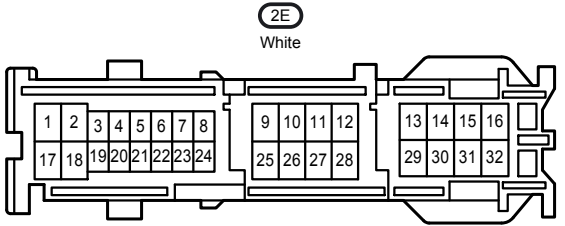
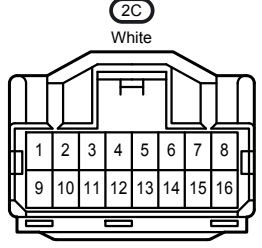
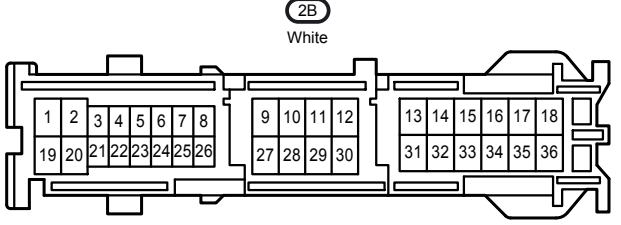
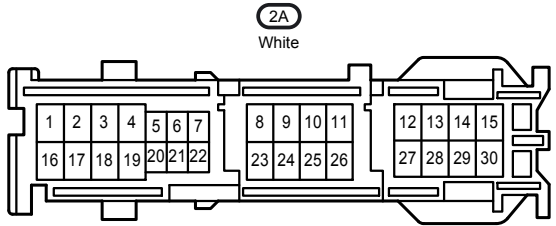
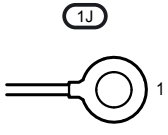

4A  
White

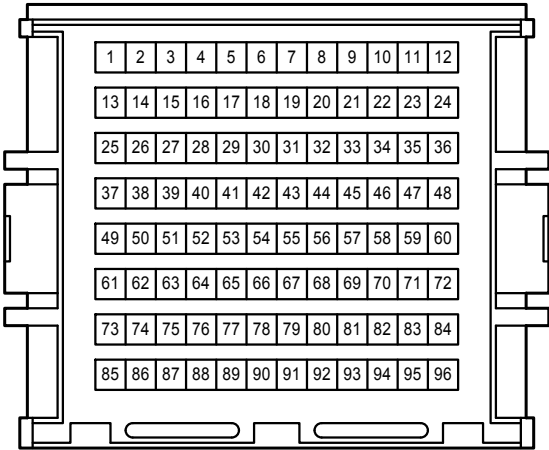

4B  
White

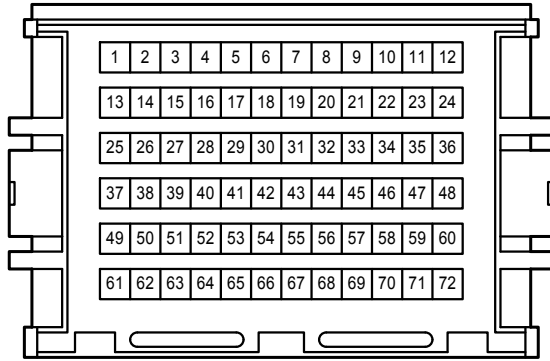

4C  
White

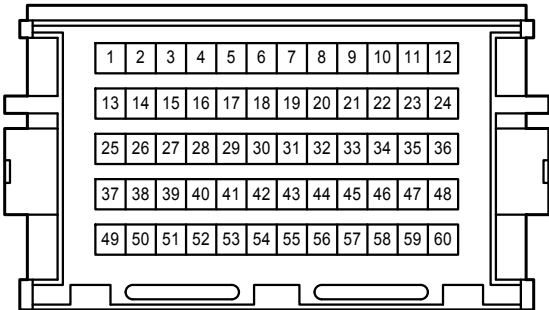

AE1  
White

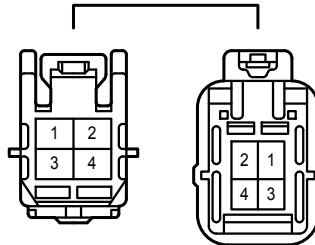

AE3  
White

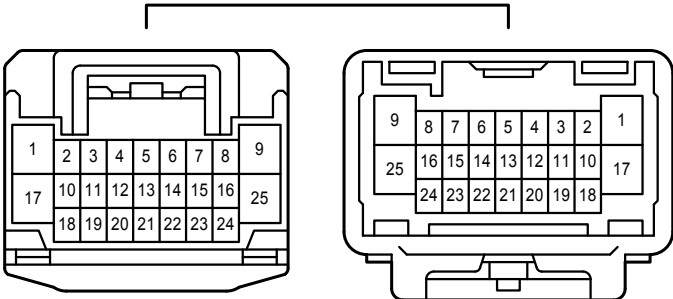

AE6  
Gray

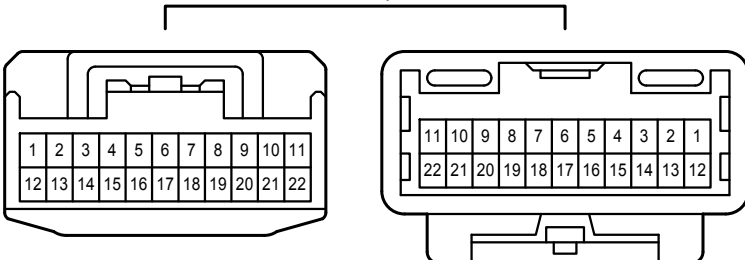

AE10  
Gray

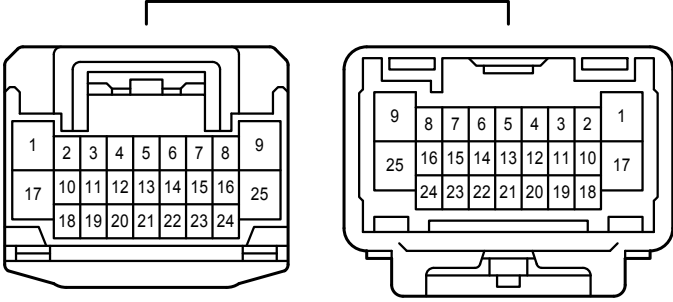

AE11  
White

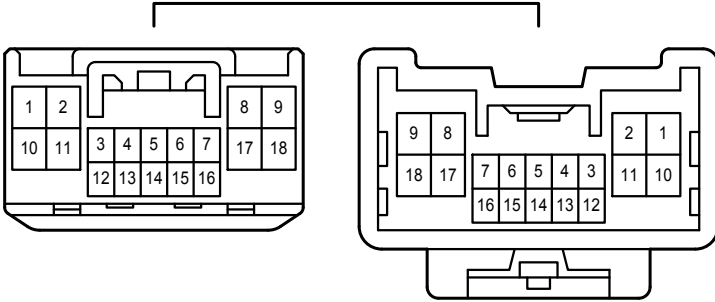

BA2  
White

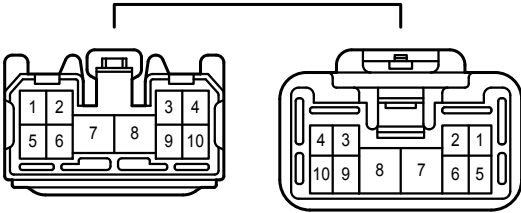

EL1  
White

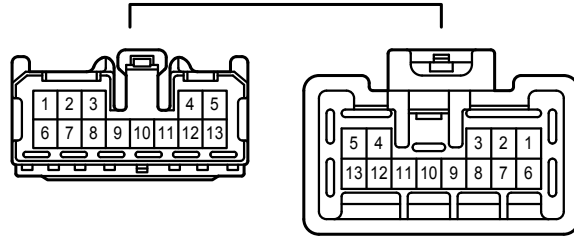

EL2  
White

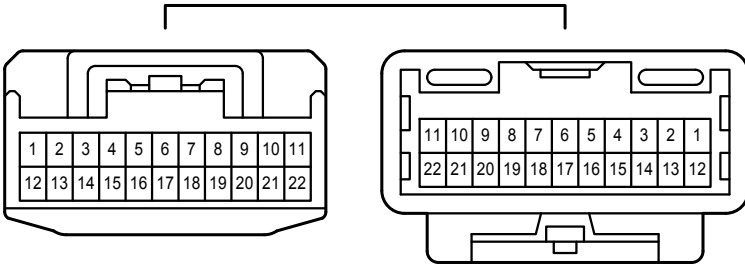

EM1  
Gray

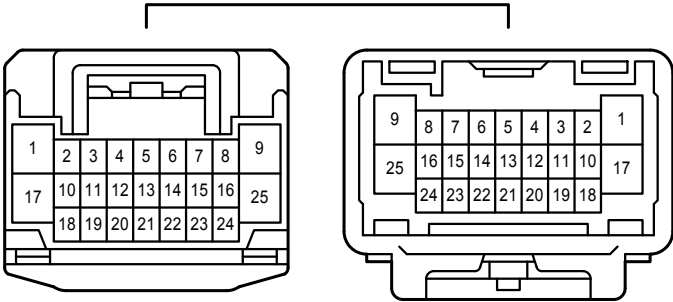



EM2  
White

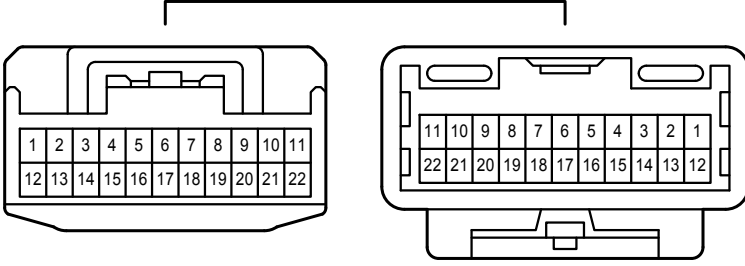

HE1  
Blue

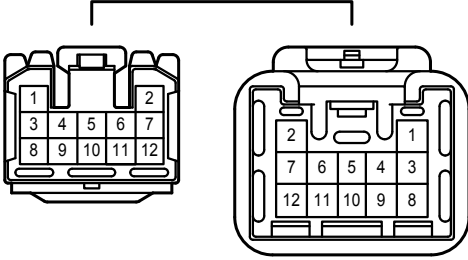

HE2  
White

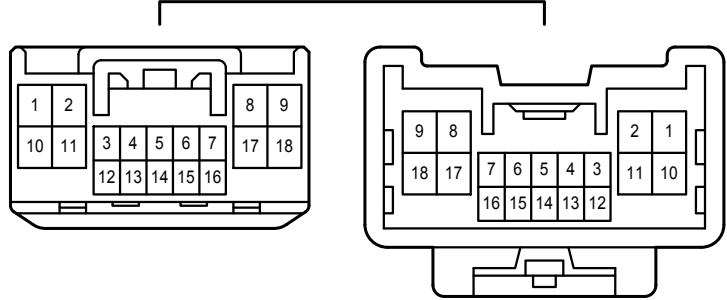

HE3  
White

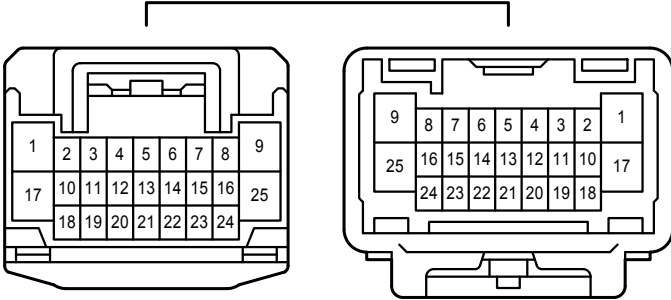

HS1  
Gray

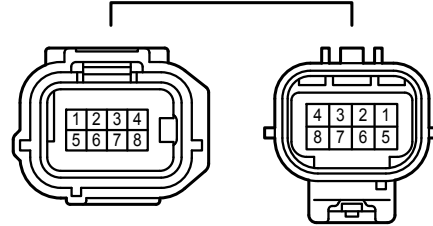

IE1  
Blue

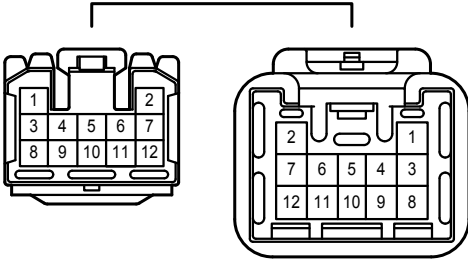

IE2  
White

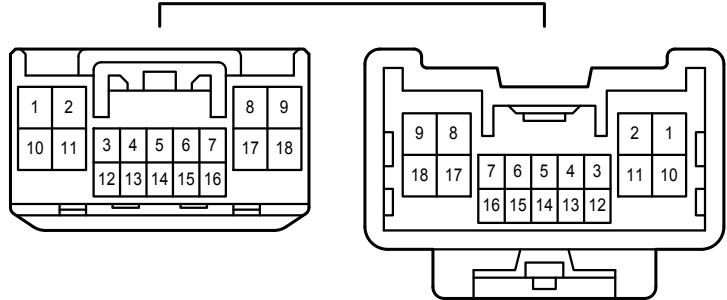

IE3  
White

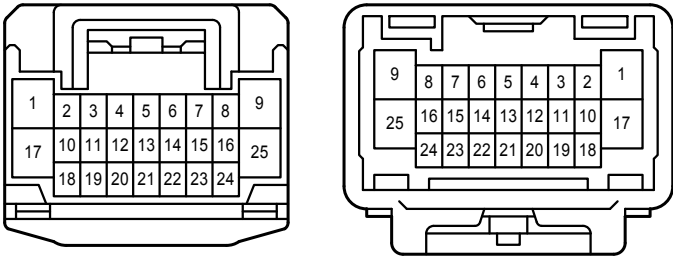

IT1  
Gray

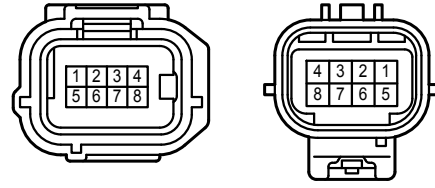

JM1  
White

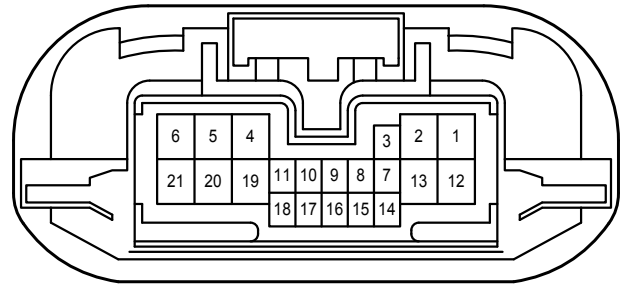
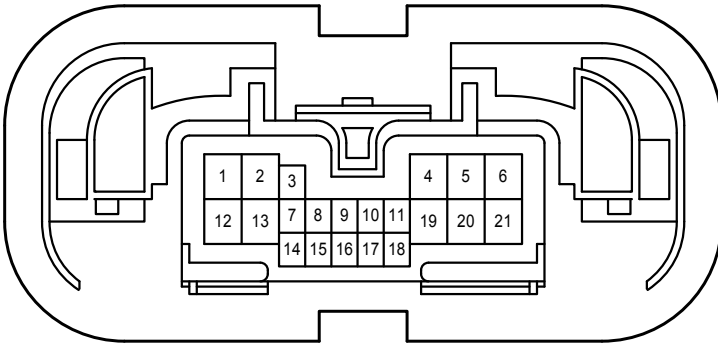

KL1  
White

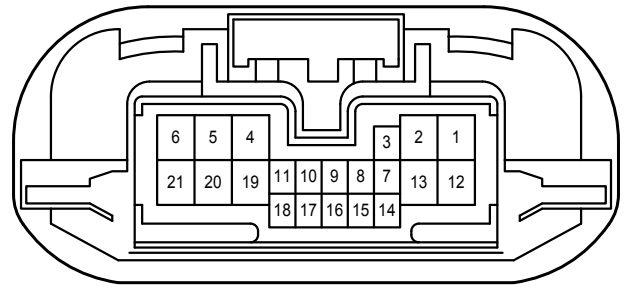
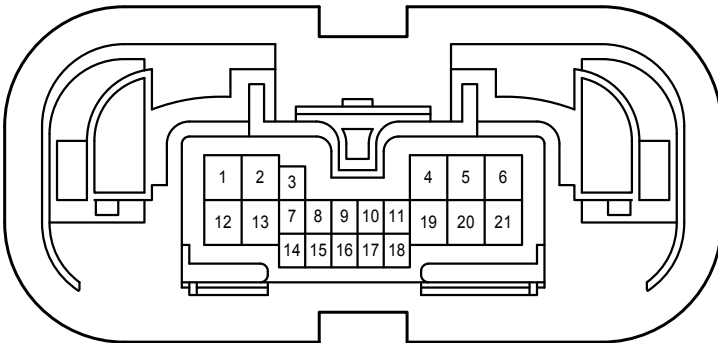

Engine Immobiliser System <w/o Smart Key System , TMC Made>

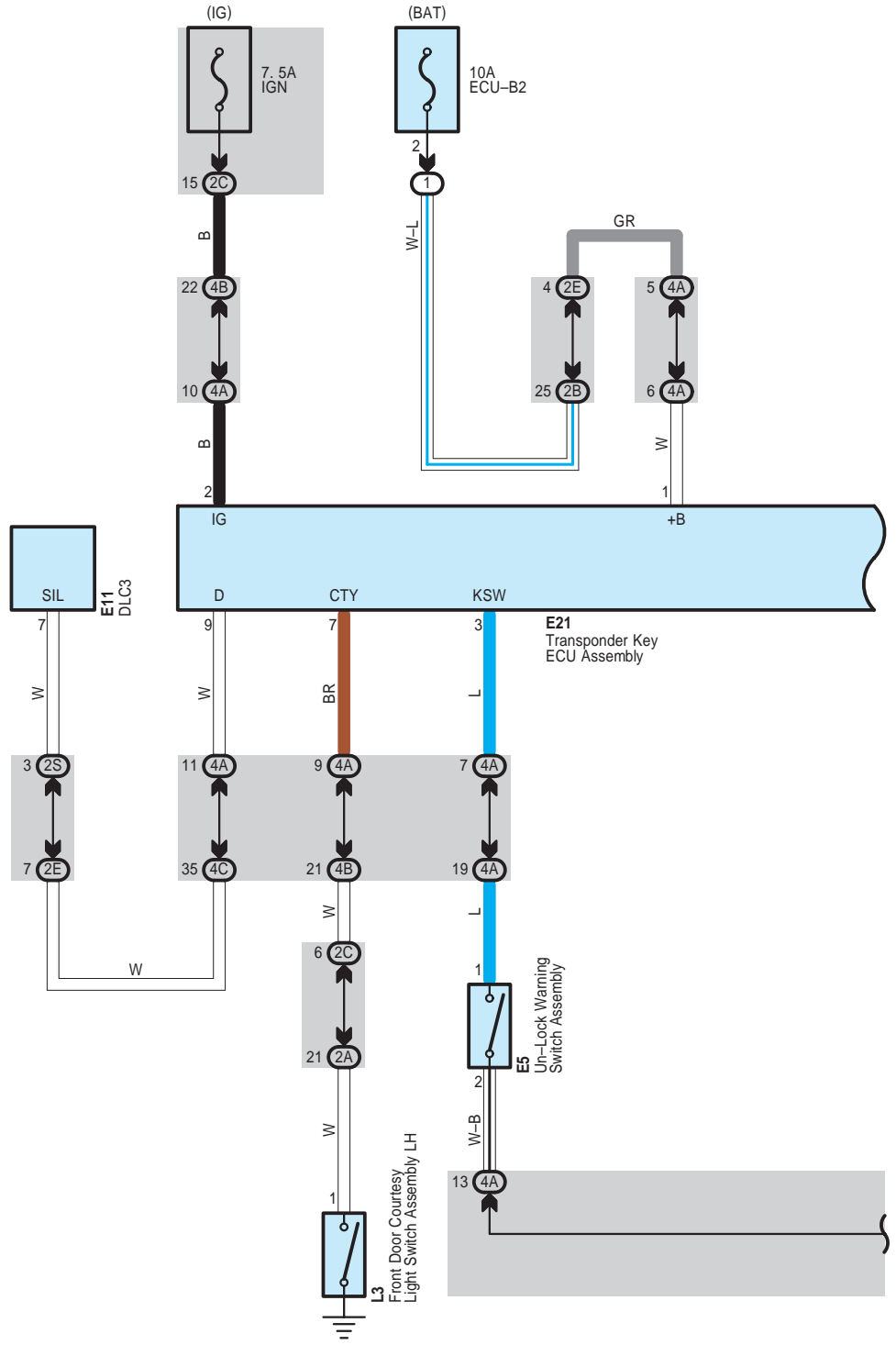

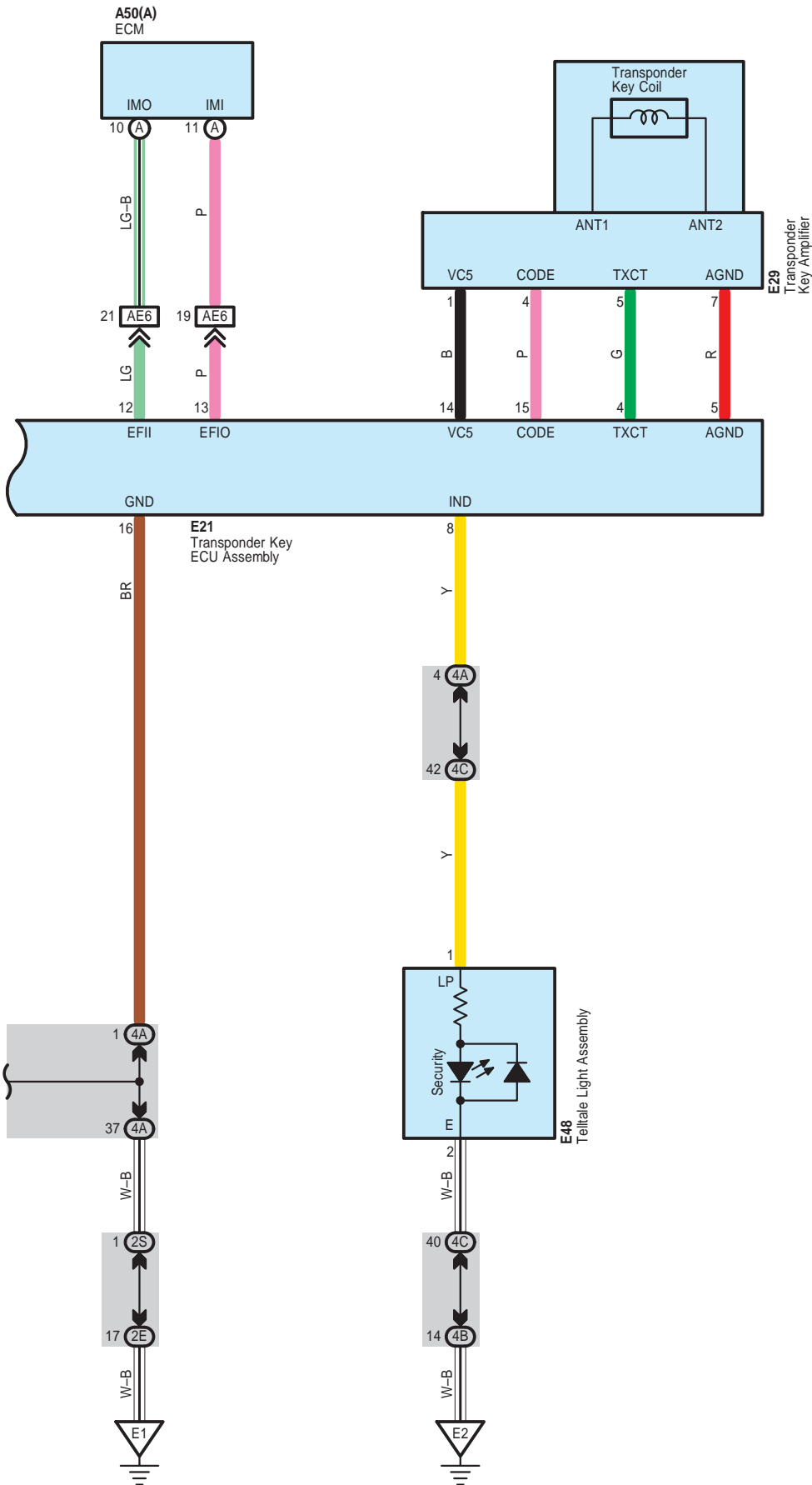

Engine Immobiliser System <w/o Smart Key System , TMC Made>

A 50  
Black

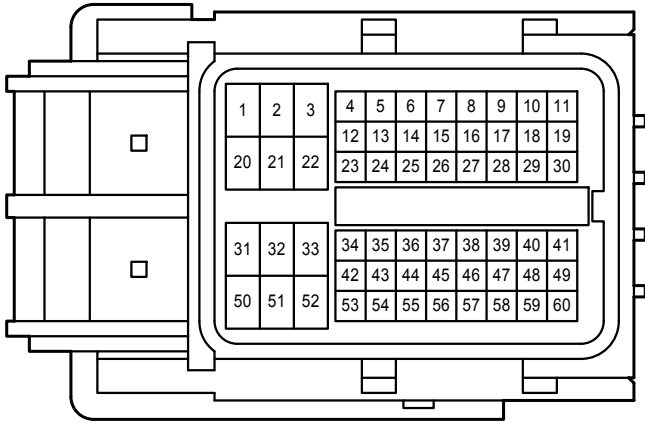

E 5  
White



E 21  
White

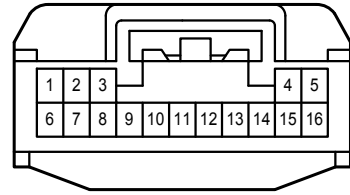

E 29  
Black

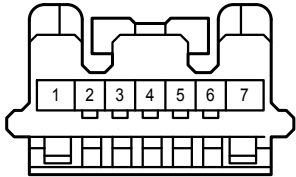

E 48  
Black

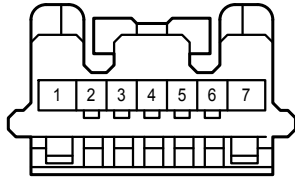

L 3  
Black



2A  
White

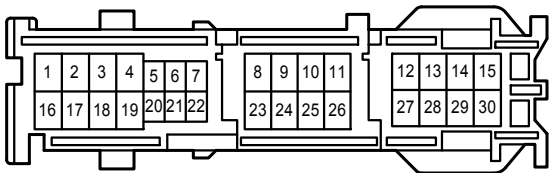

2B  
White

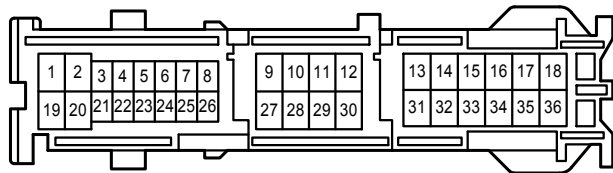

2C  
White

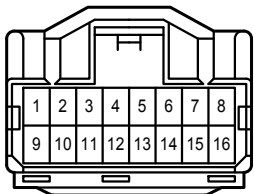

2E  
White

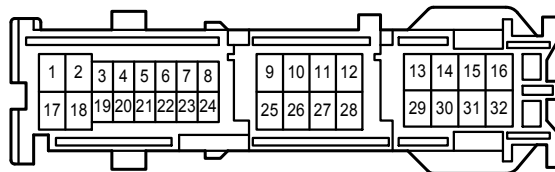

2S  
White

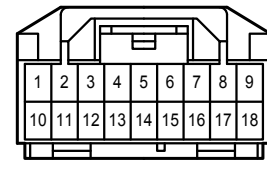

4A  
White

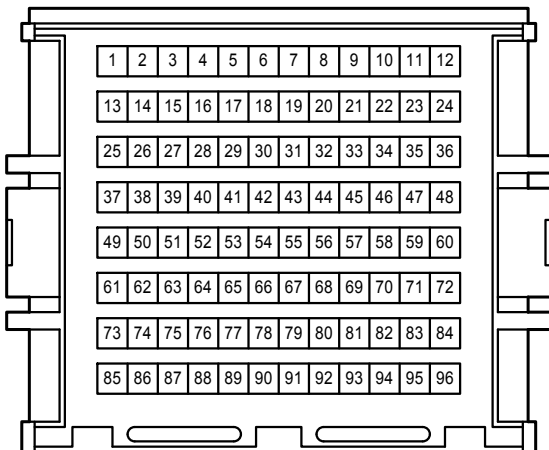

4B  
White

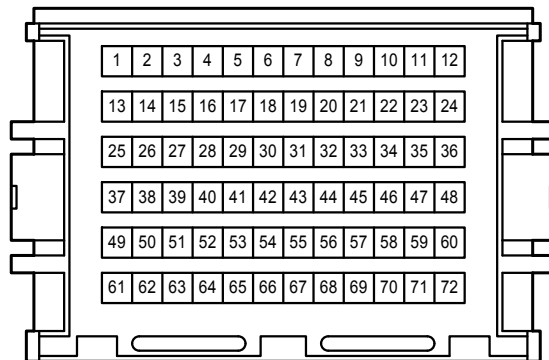

4C  
White

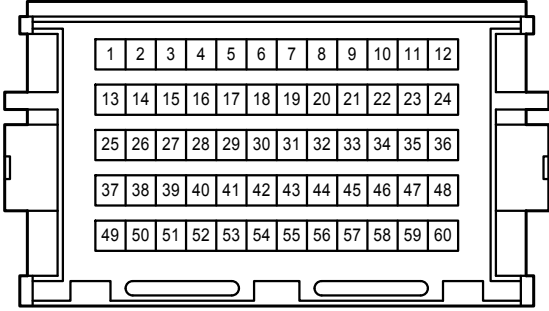

AE6  
Gray

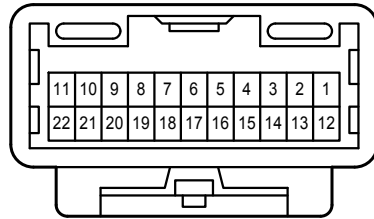
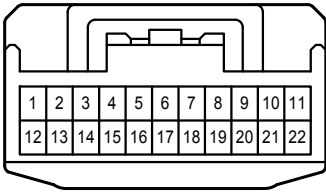

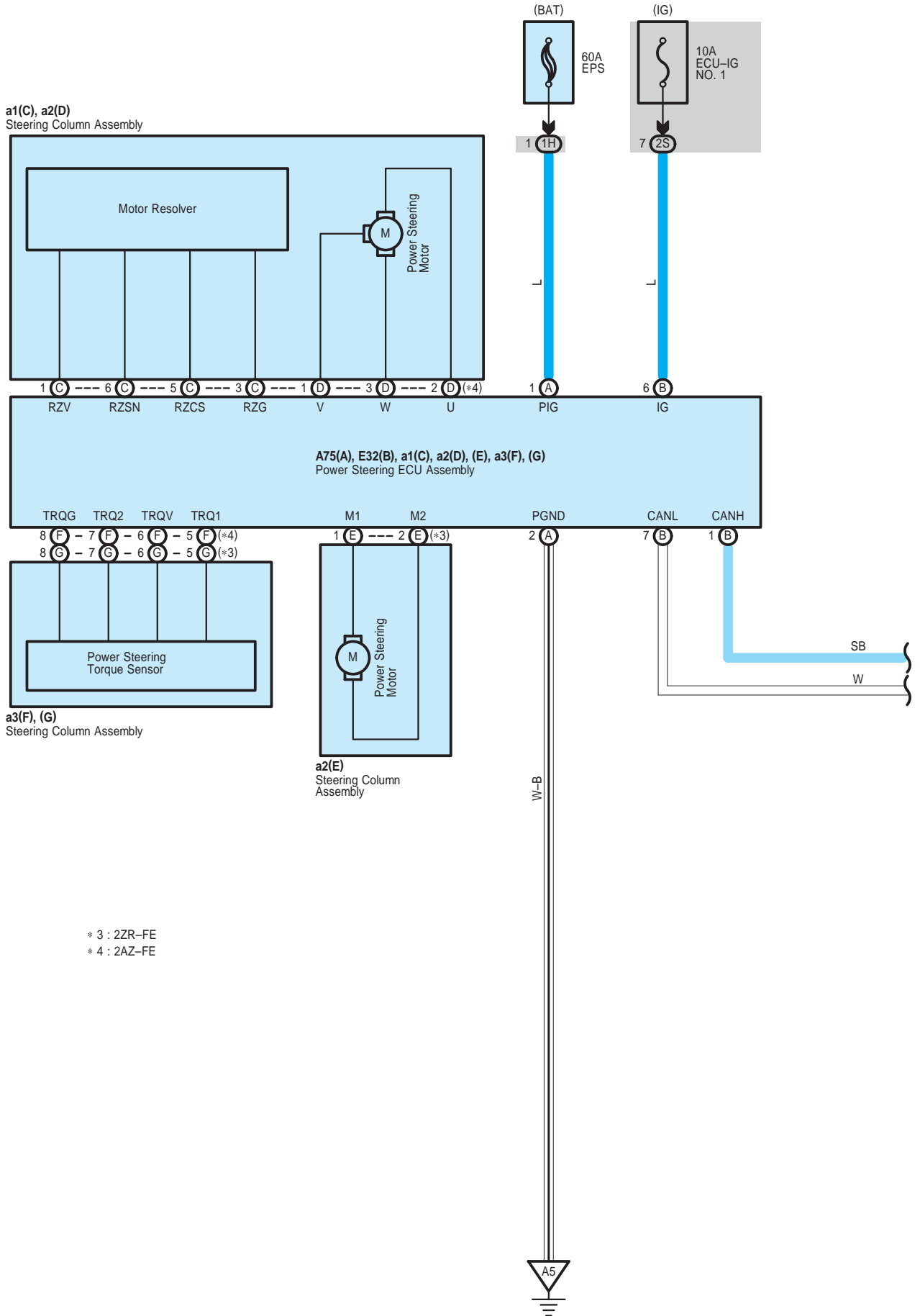

\* 3 : 2ZR-FE  
\* 4 : 2AZ-FE

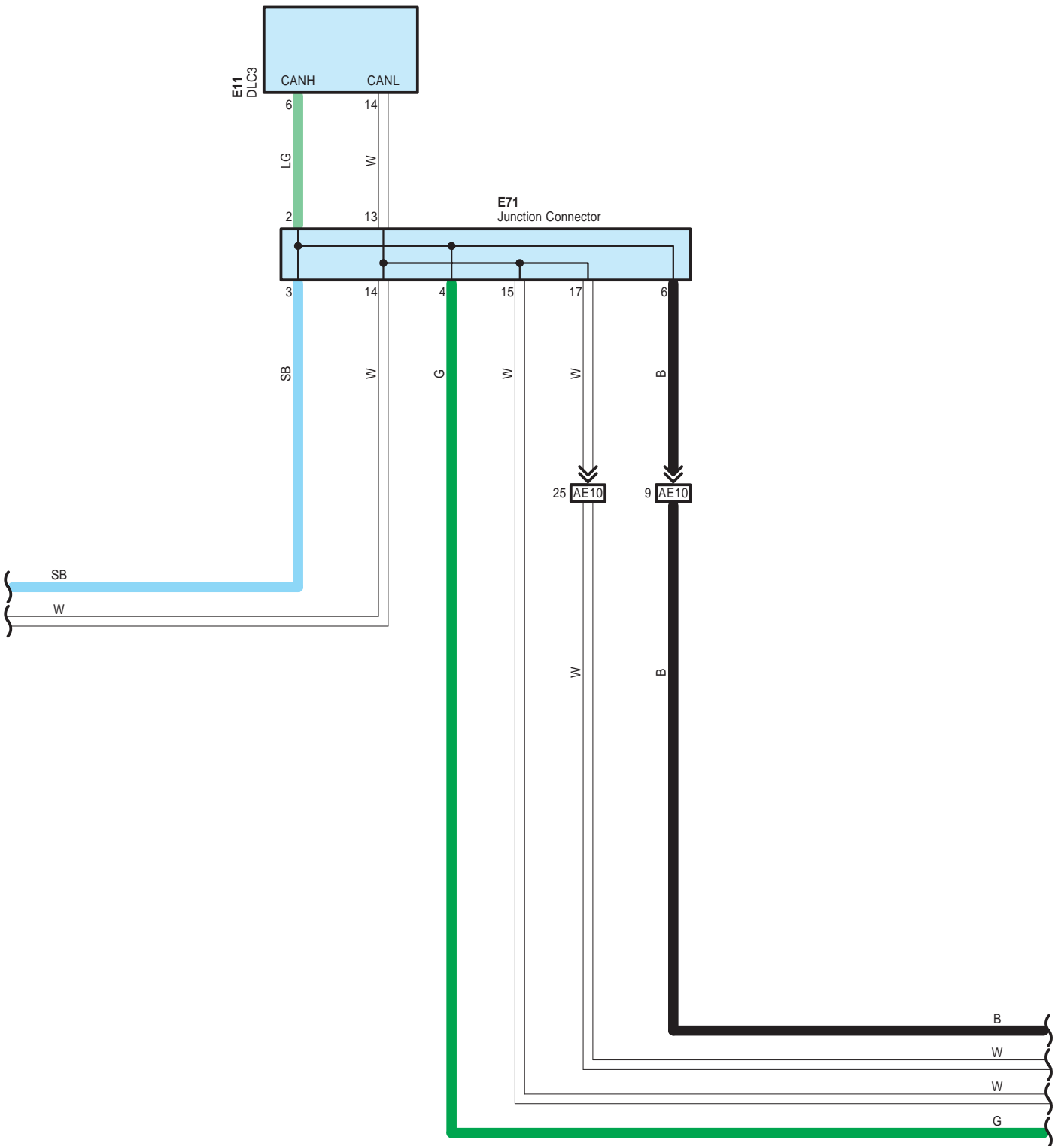



- \* 1 : w/o VSC
- \* 2 : w/ VSC
- \* 3 : 2ZR-FE
- \* 4 : 2AZ-FE

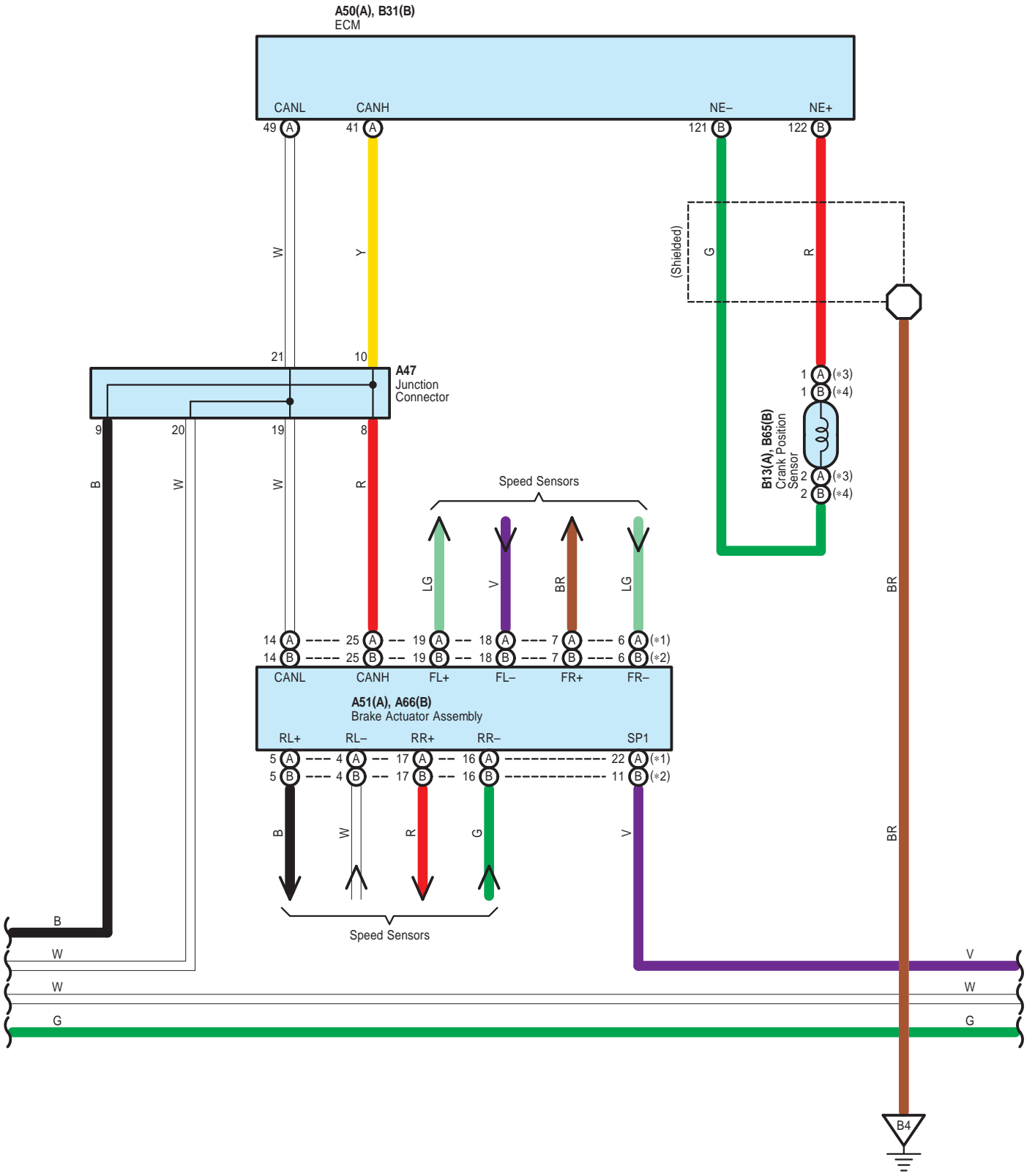

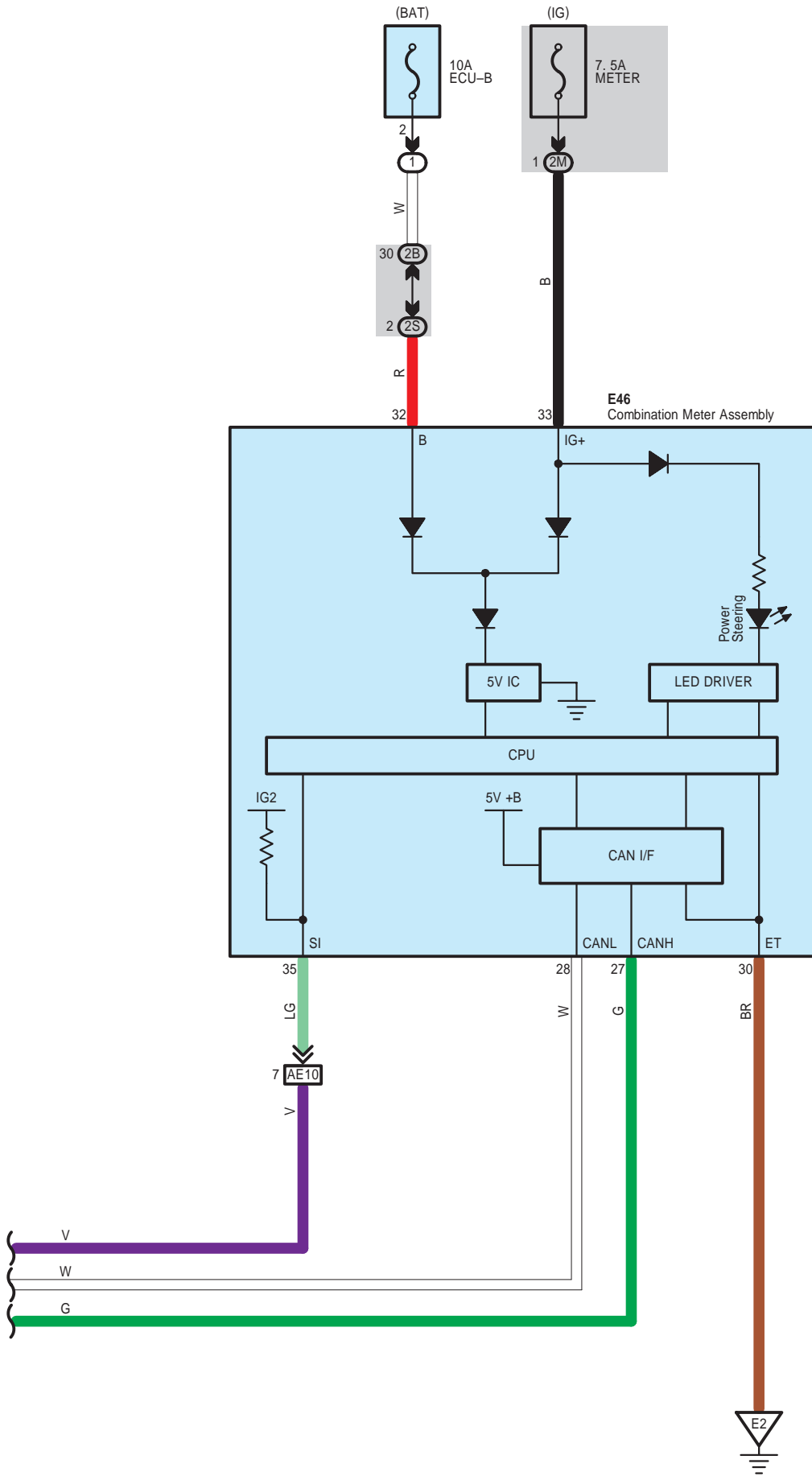

A 47  
White

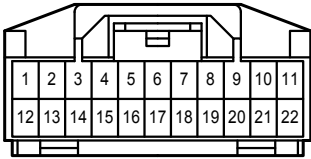

A 50  
Black

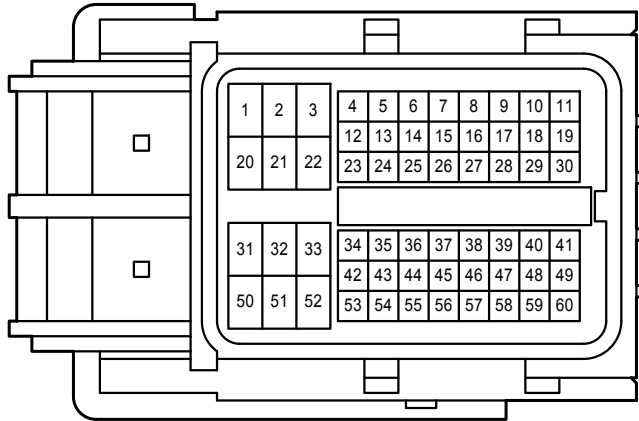

A 51  
Gray

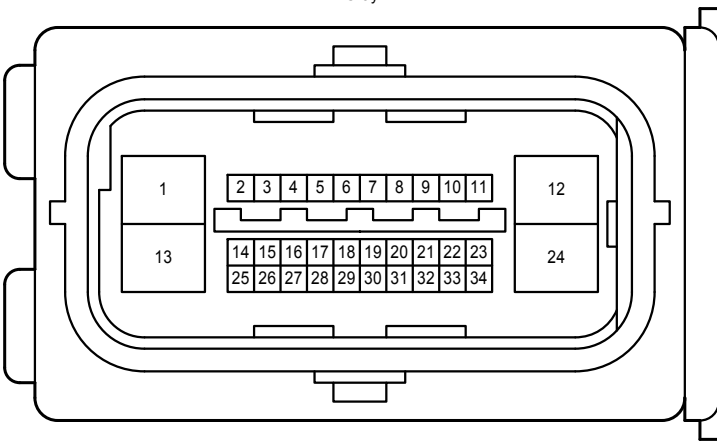

A 66  
Black

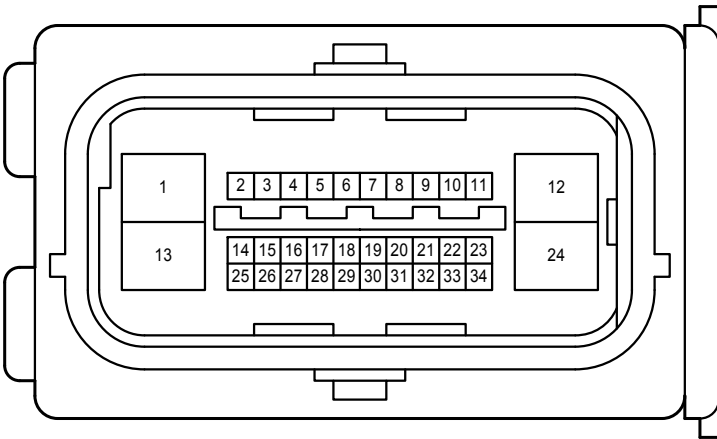

A 75  
Gray

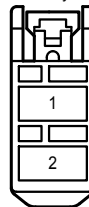

B 13  
Black

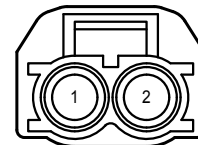

B 31  
Black

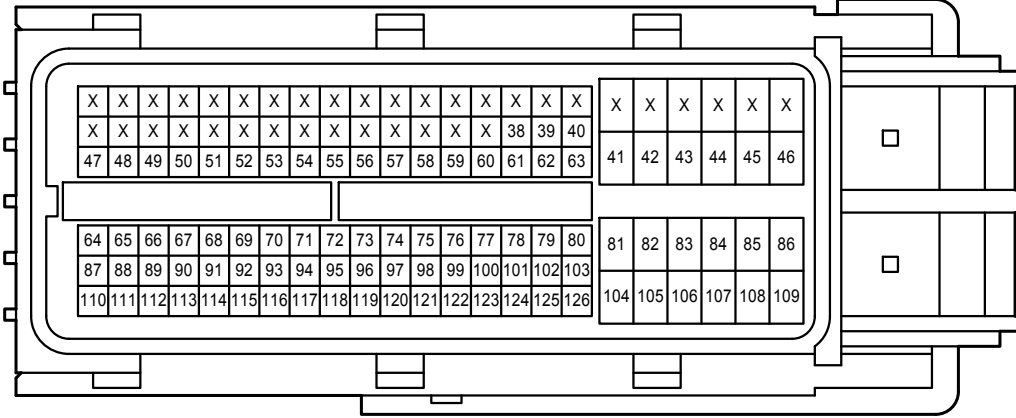

B 65  
Gray



E 11  
White

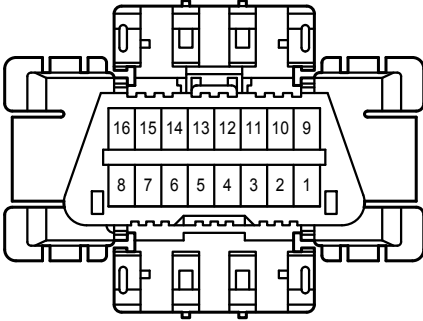

E 32  
White

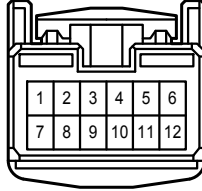

E 46  
White

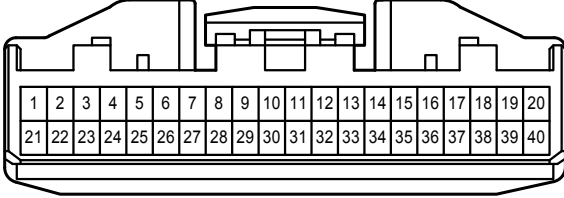

E 71  
White

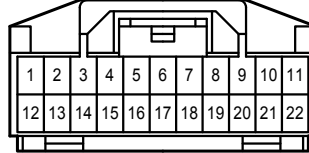

a 1  
White

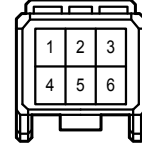

a 2  
White

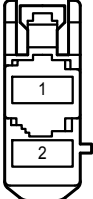

(2ZR-FE)

a 2  
White

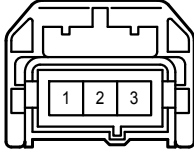

(2AZ-FE)

a 3  
White

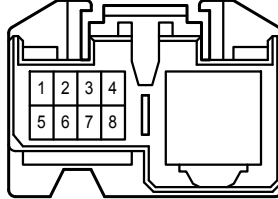

(2AZ-FE)

a 3  
Black

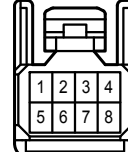

(2ZR-FE)

1H



1

2B  
White

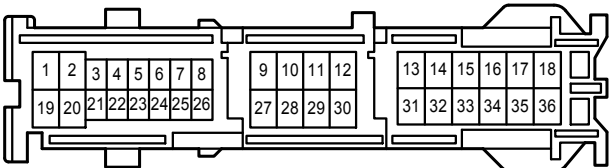

2M  
White

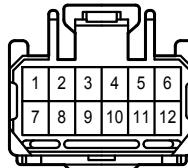

2S  
White

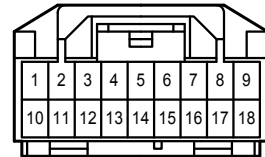

AE10  
Gray

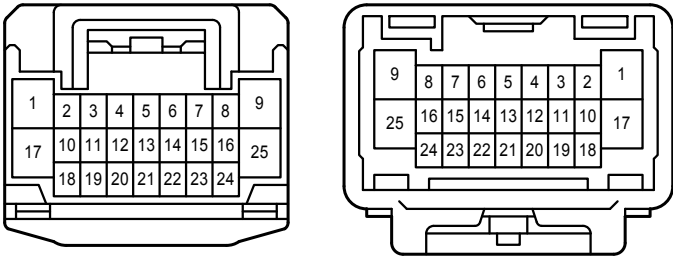

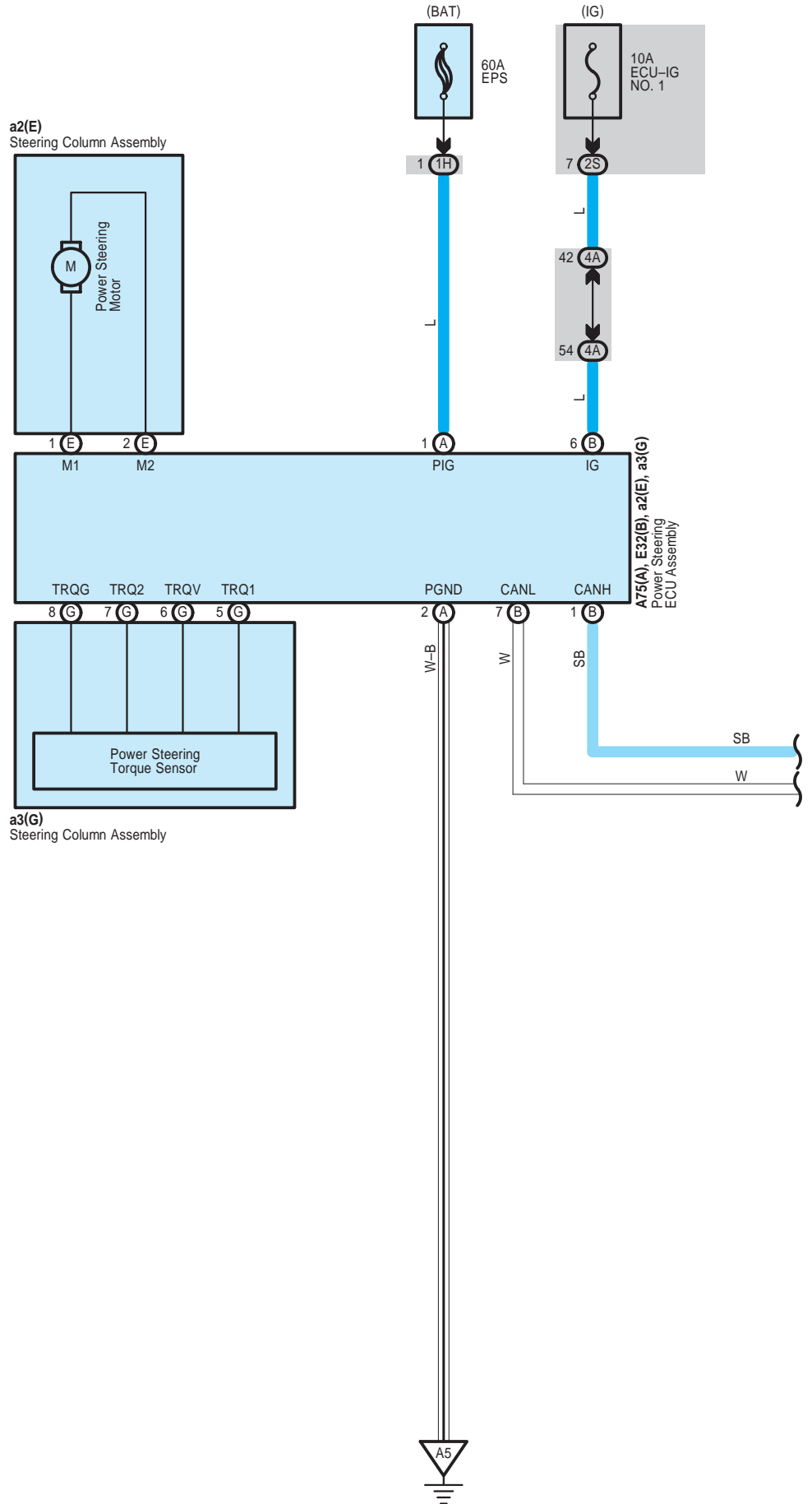

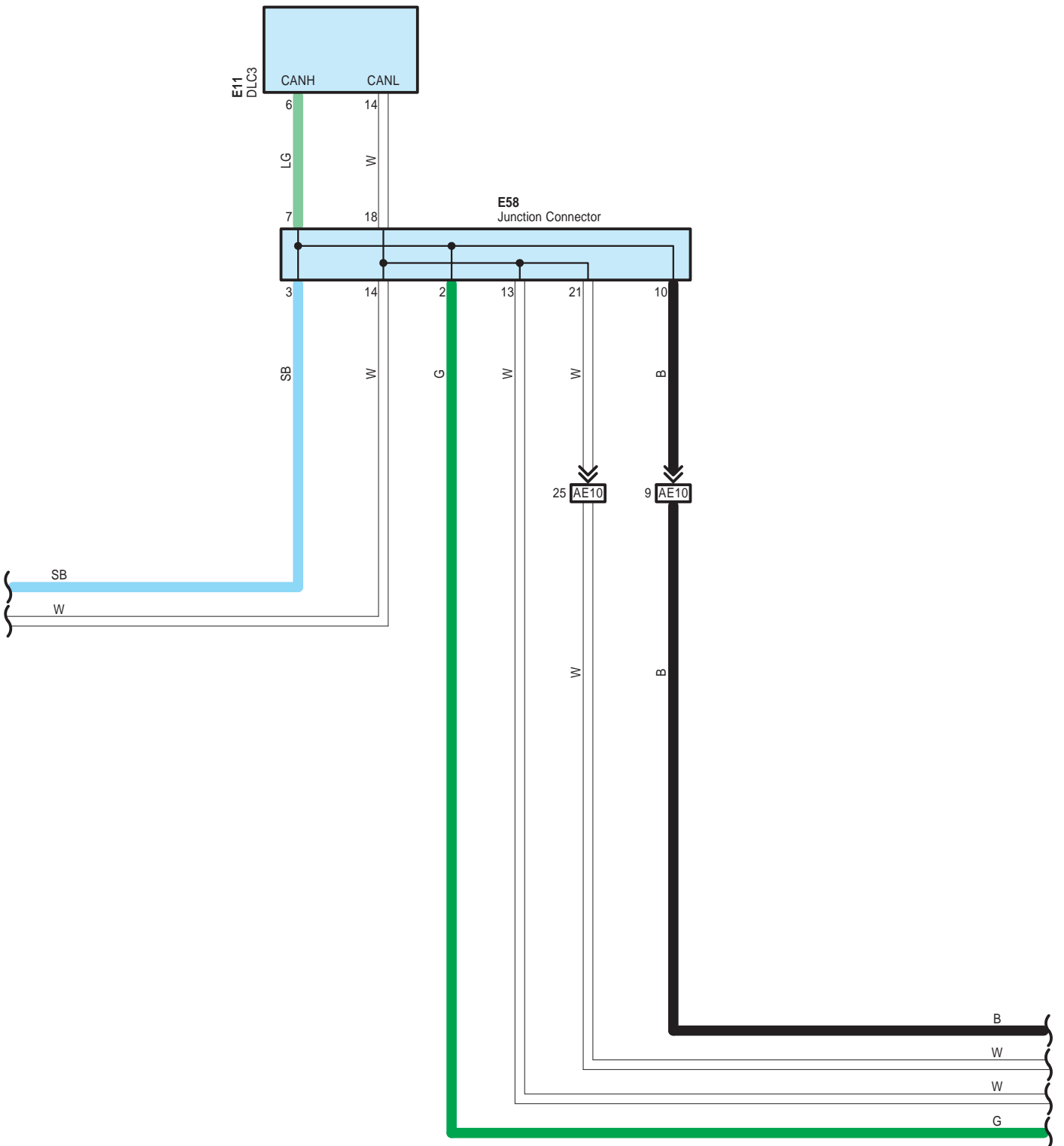

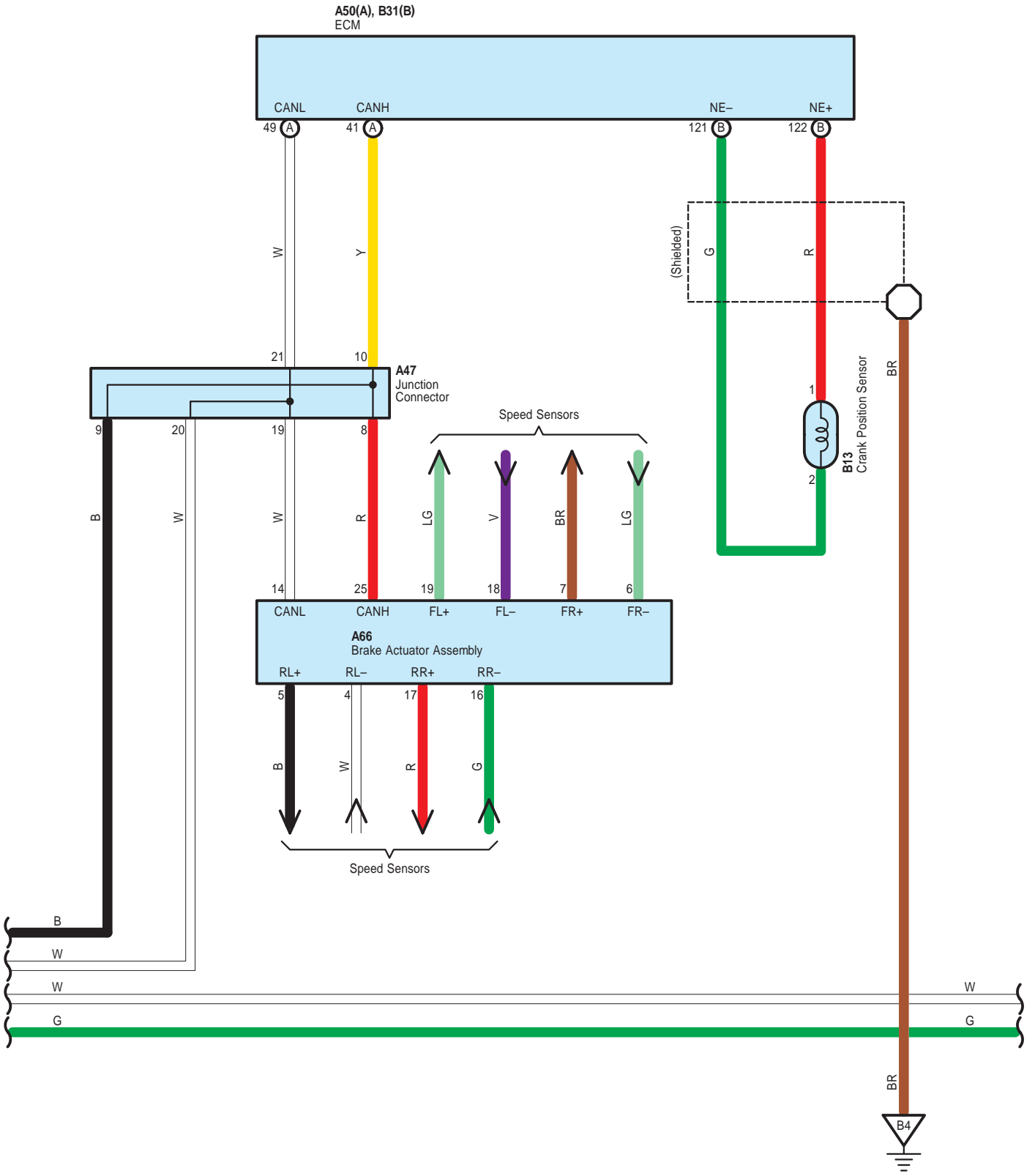



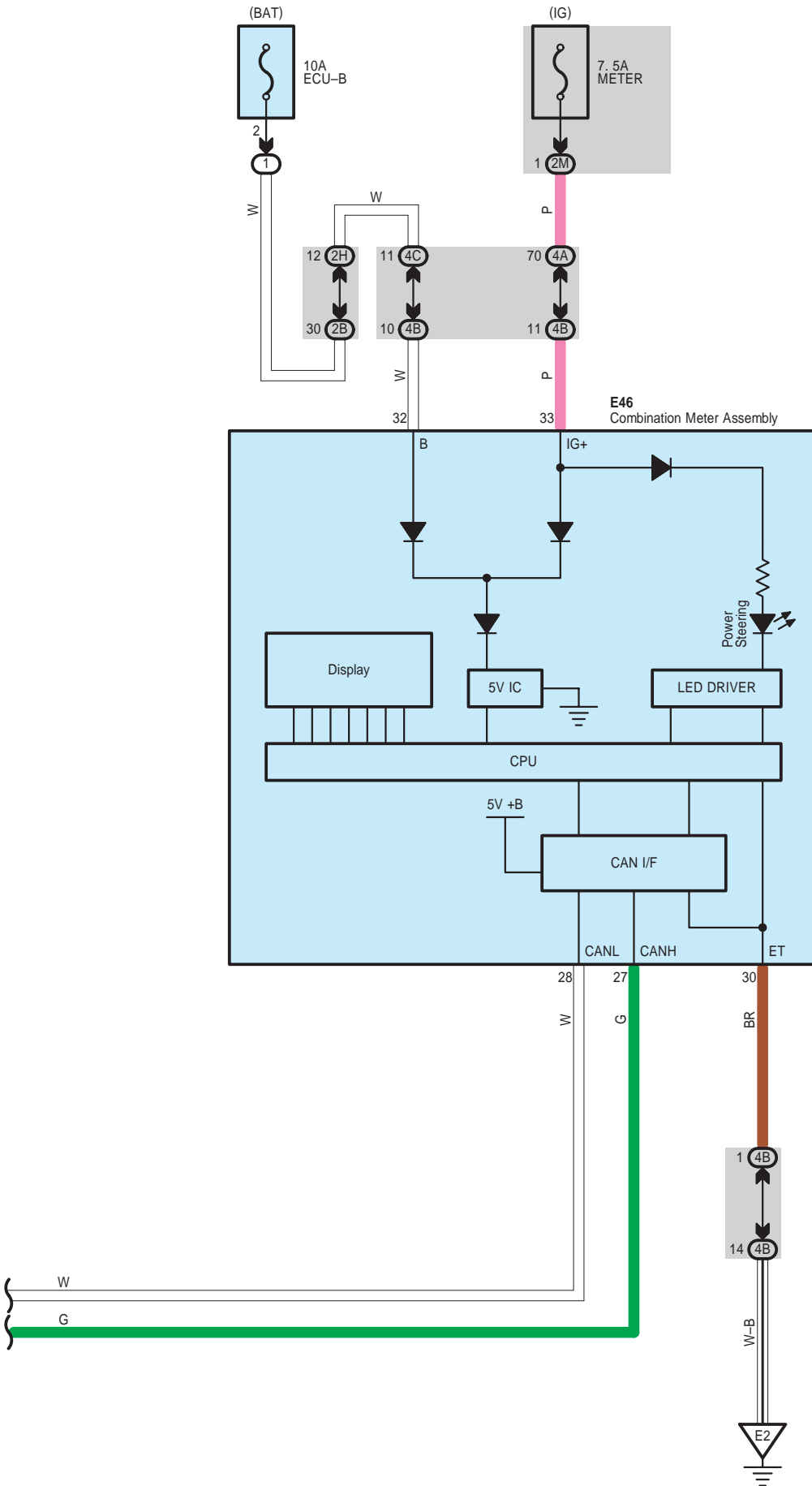



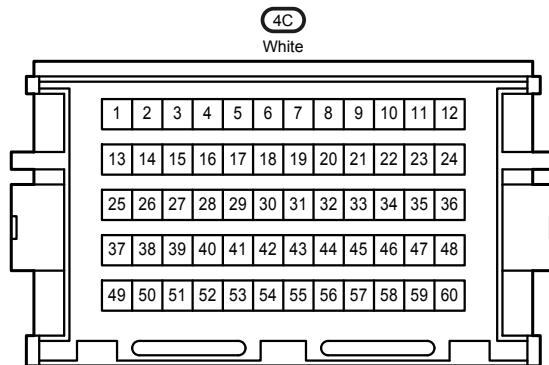
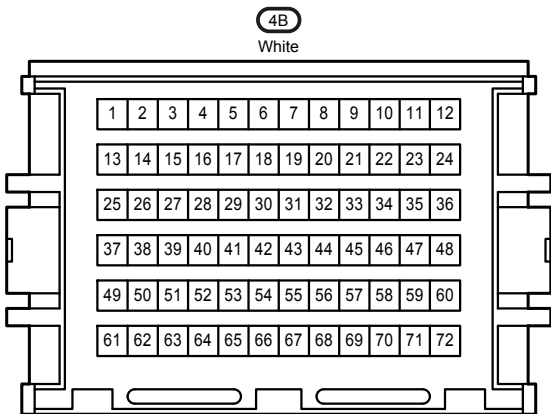
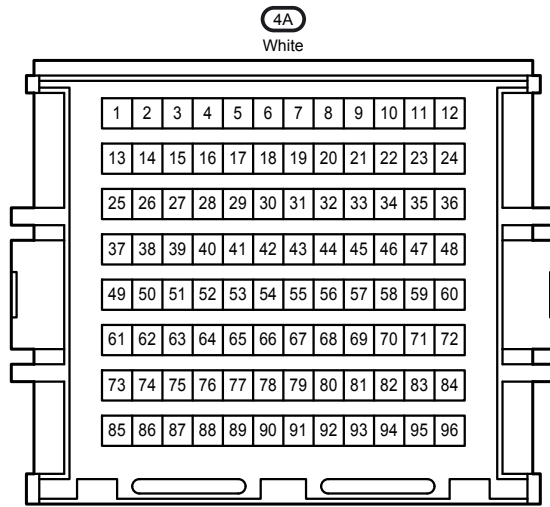
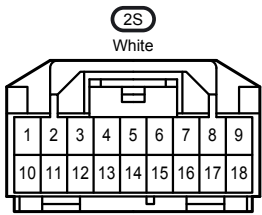
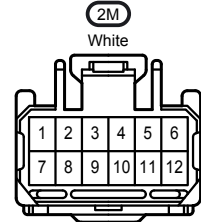
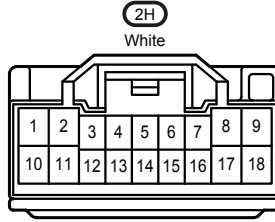
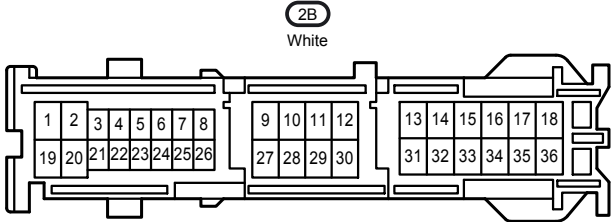
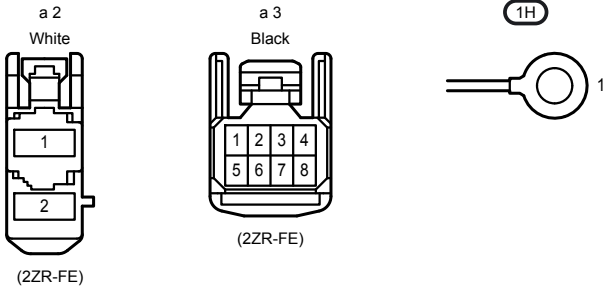

AE10  
Gray

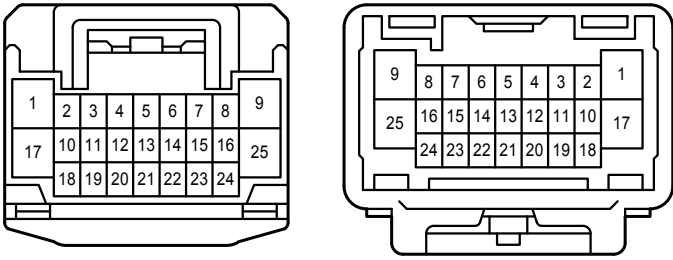

Front Fog Light <Except TMC Made>

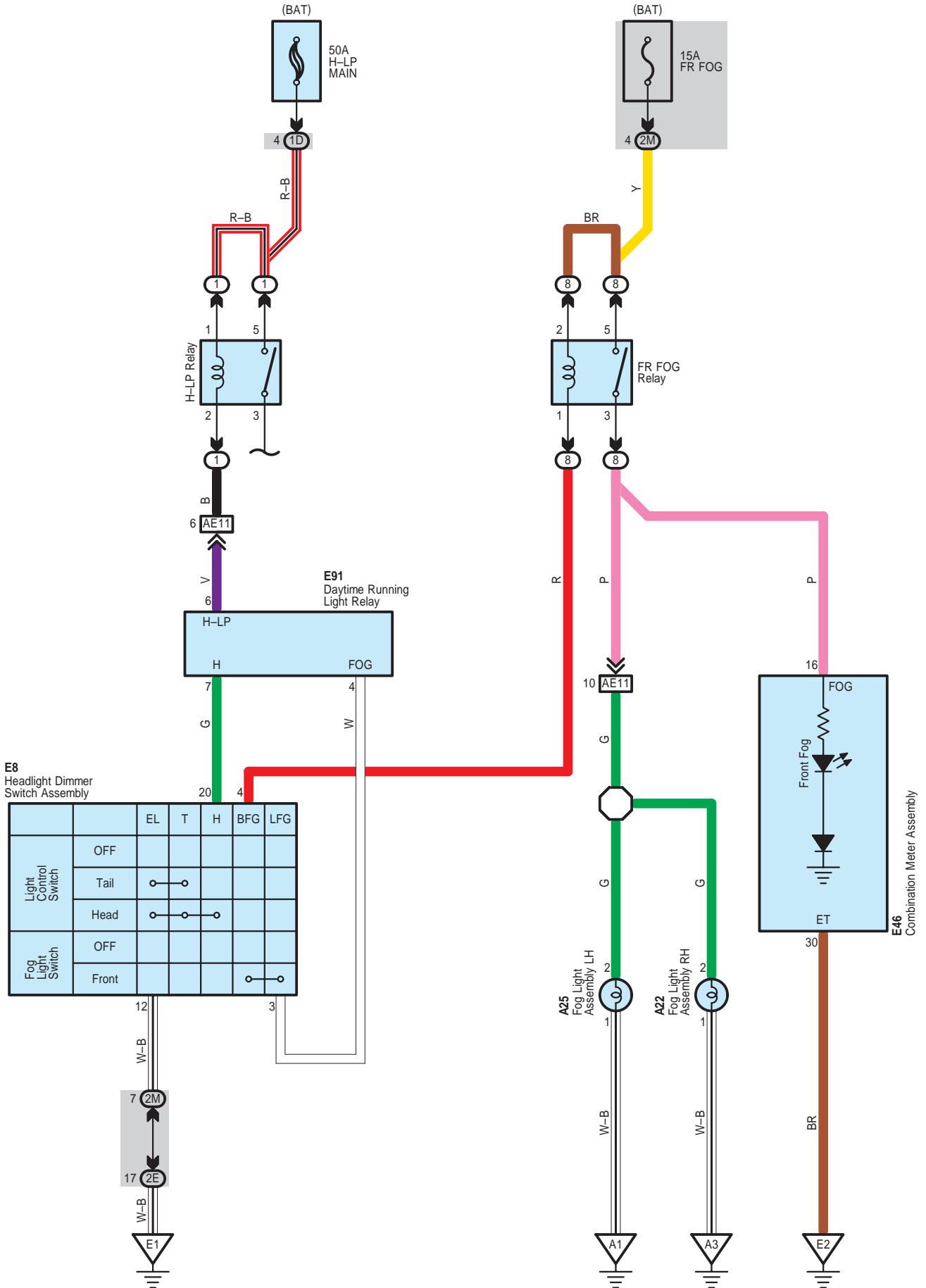

Front Fog Light <Except TMC Made>

A 22  
Black

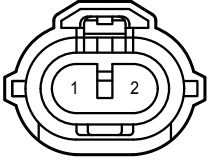

A 25  
Black

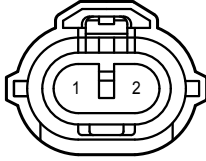

E 8  
White

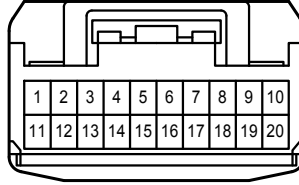

E 46  
White

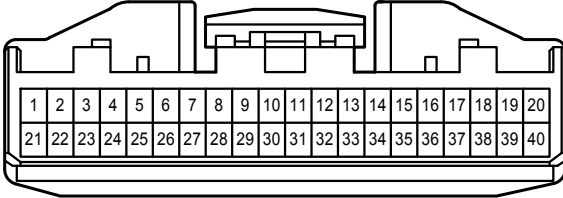

E 91  
White

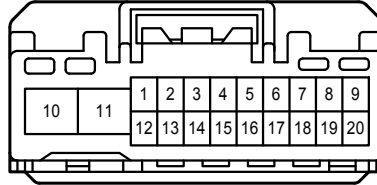

1D  
White

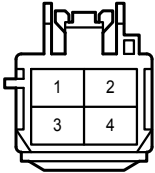

2E  
White

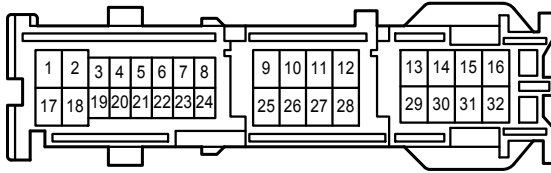

2M  
White

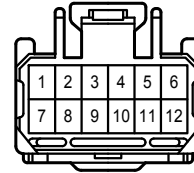

AE11  
White

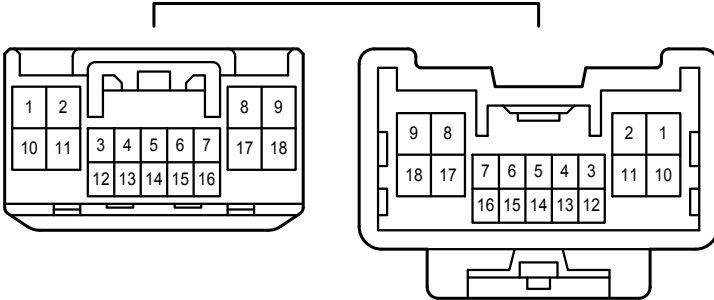

Front Fog Light <TMC Made>

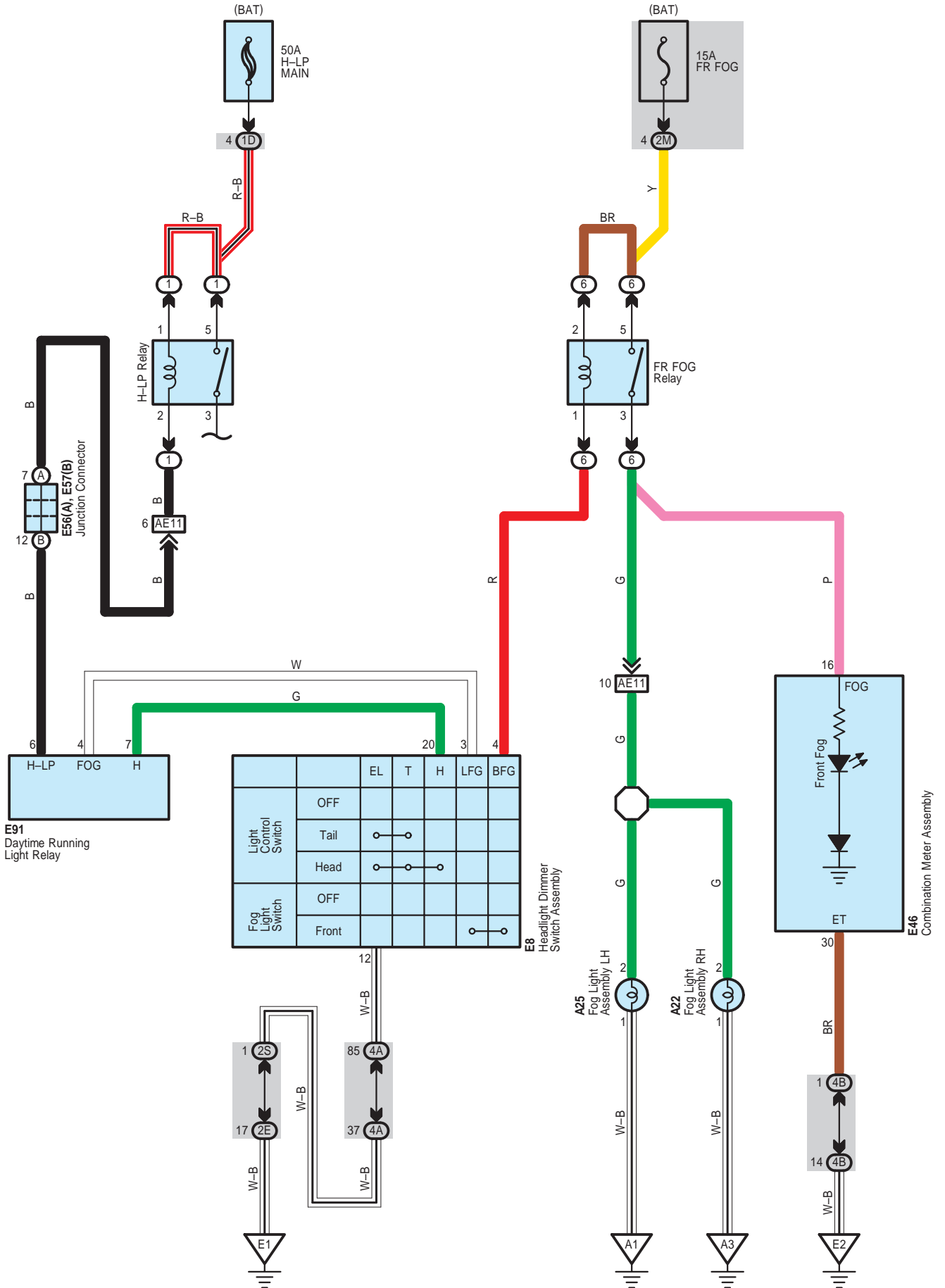

Front Fog Light <TMC Made>

A 22

Black

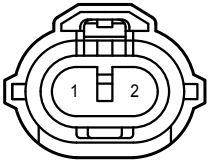

A 25

Black

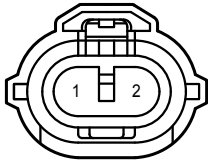

E 8

White

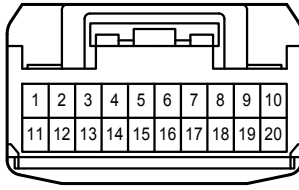

E 46

White

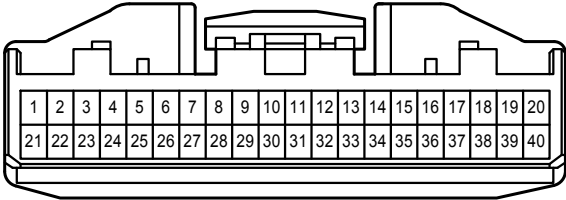

E 56

White

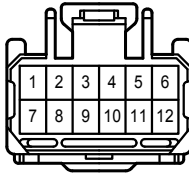

E 57

White

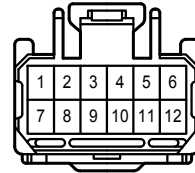

E 91

White

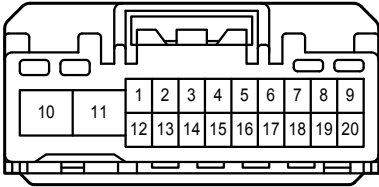

1D

White

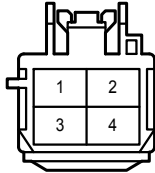

2E

White

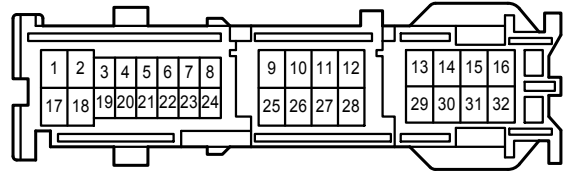

2M

White

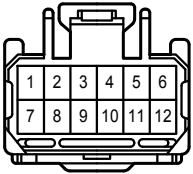

2S

White

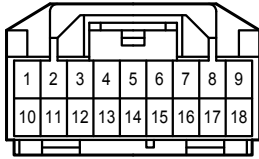

4A

White

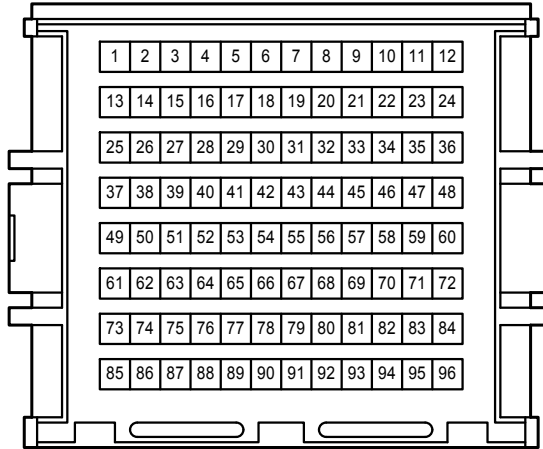

4B

White

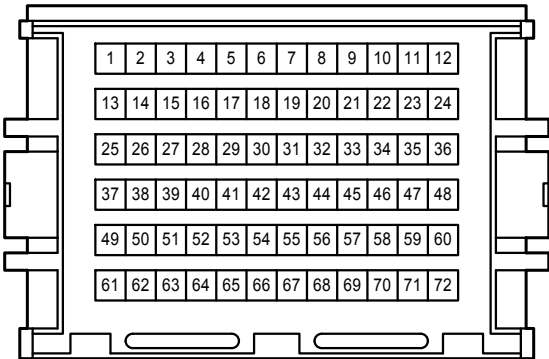



Front Fog Light <TMC Made>

AE11  
White

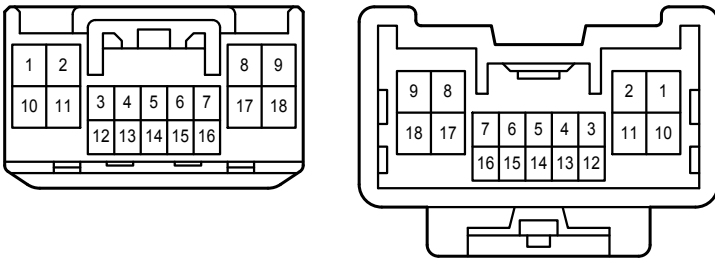

E9(A), E10(B)  
Windshield Wiper Switch Assembly

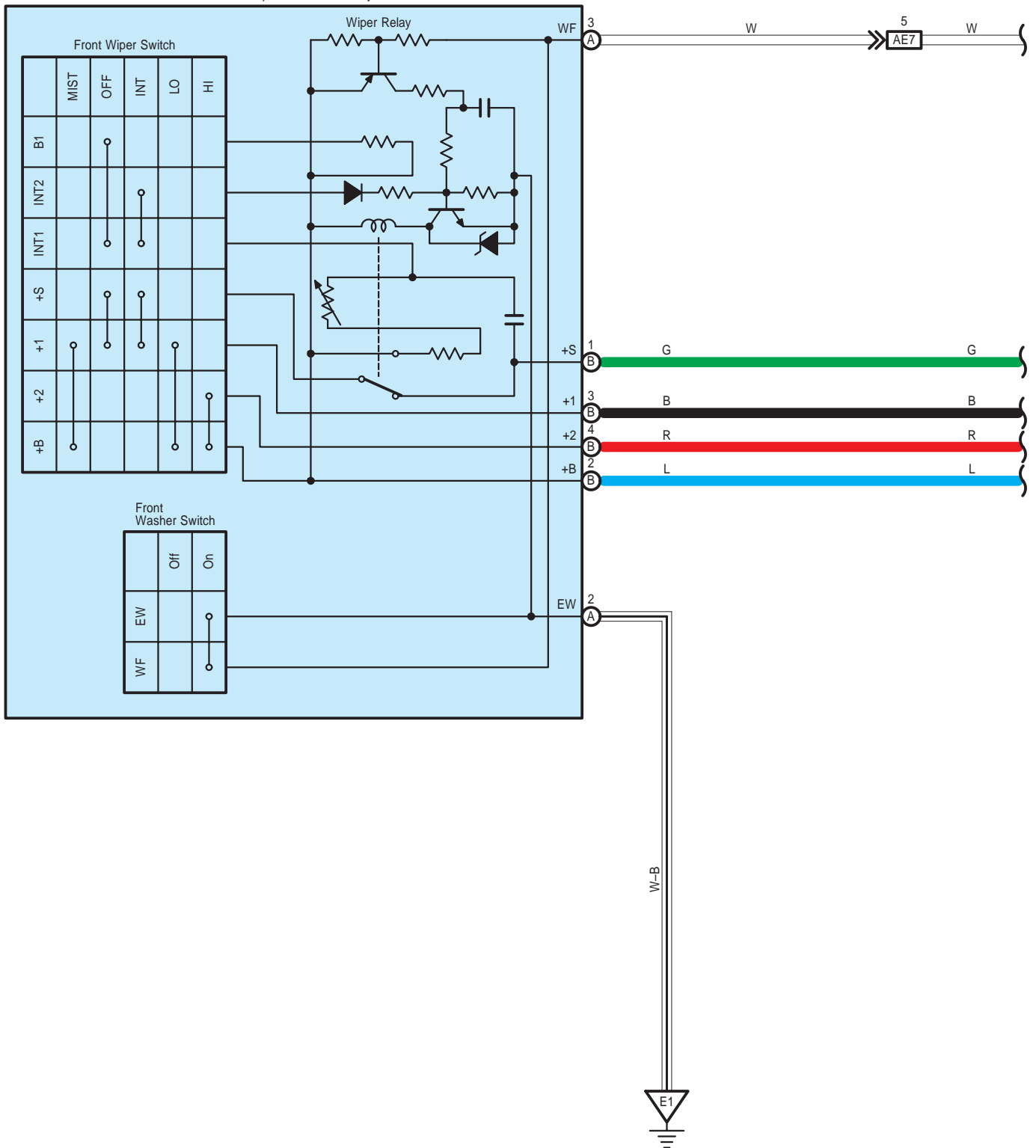

Front Wiper and Washer <Except TMC Made>

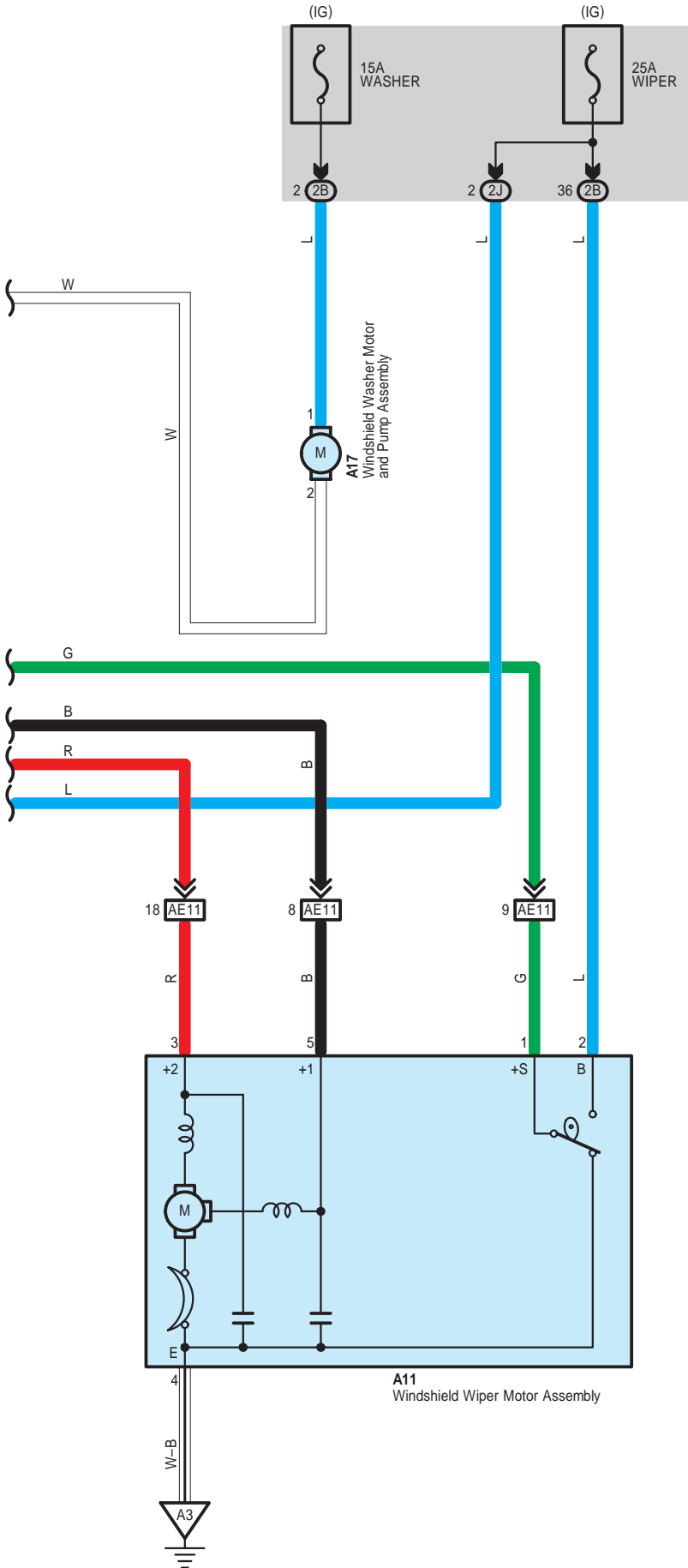

Front Wiper and Washer <Except TMC Made>

A 11

White



A 17

White

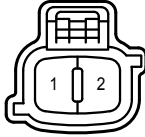

E 9

White

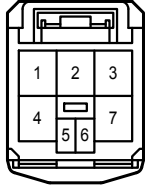

E 10

White

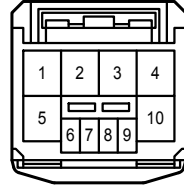

2B

White

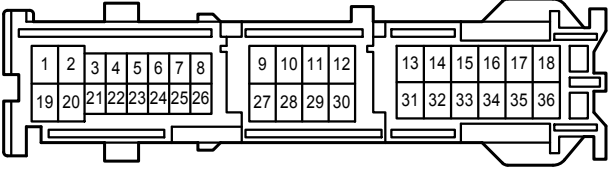

2J

White

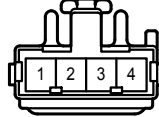

AE7

Blue

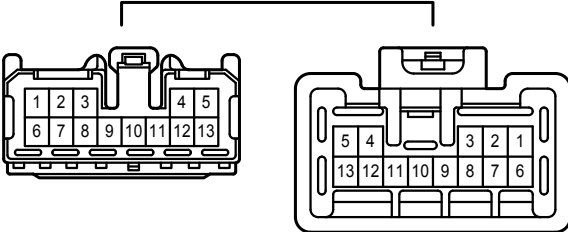

AE11

White

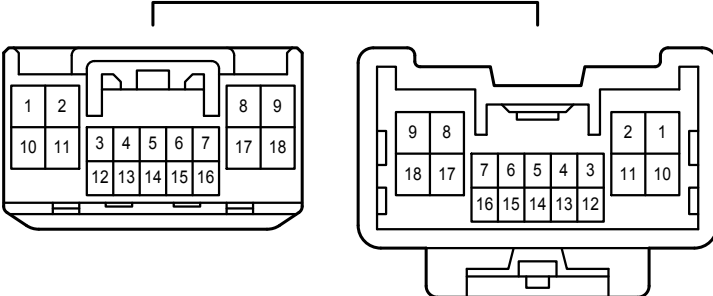

E9(A), E10(B)  
Windshield Wiper Switch Assembly

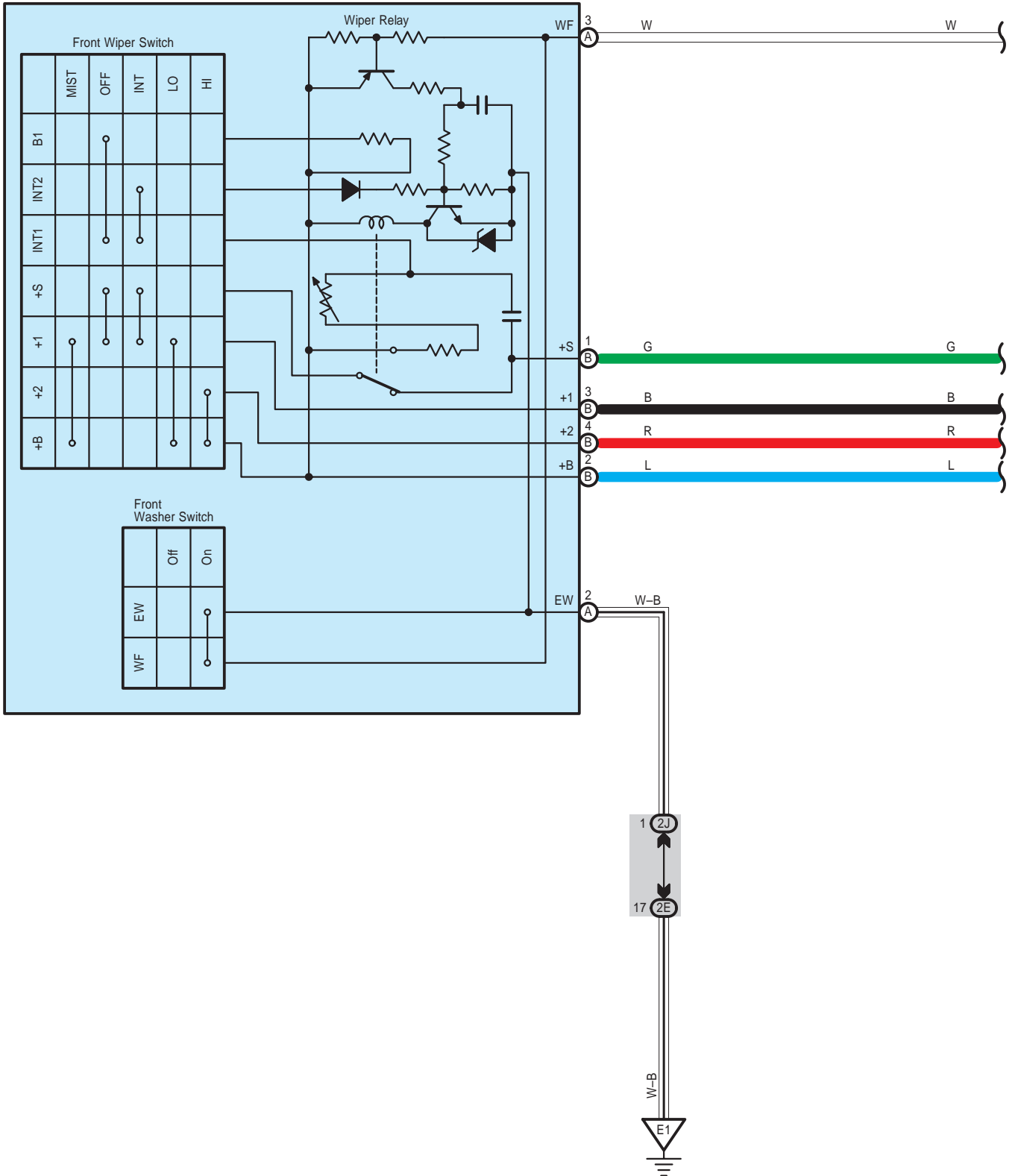

Front Wiper and Washer <TMC Made>

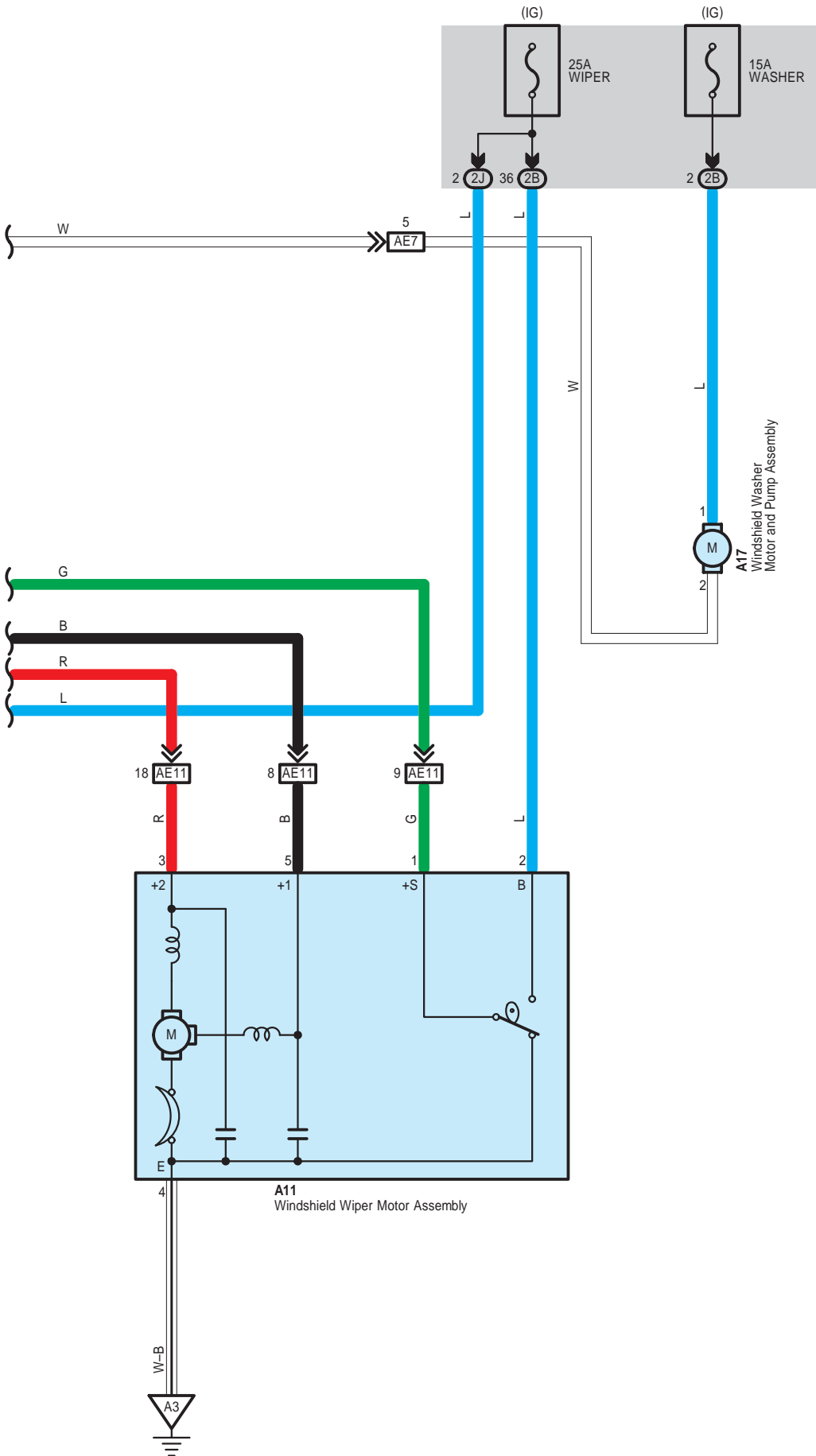

Front Wiper and Washer <TMC Made>

A 11

White

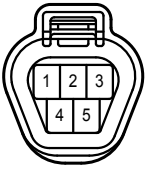

A 17

White

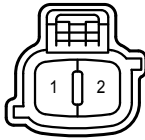

E 9

White

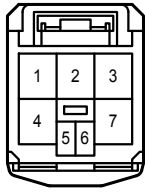

E 10

White

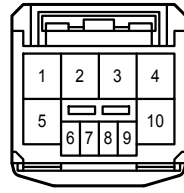

2B

White

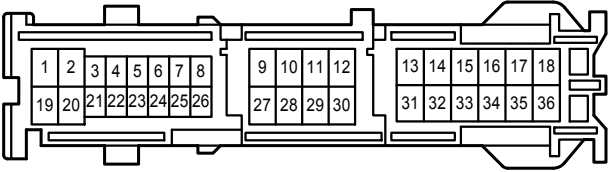

2E

White

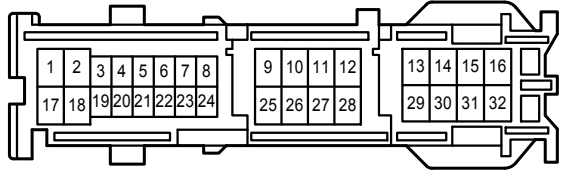

2J

White

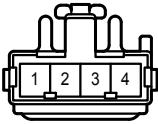

AE7

Blue

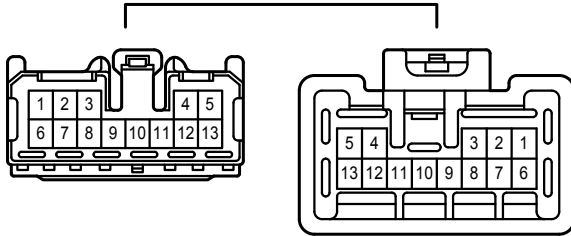

AE11

White

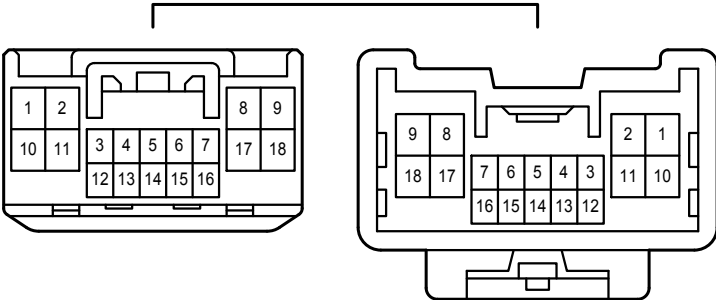

Ground Point <Except TMC Made>

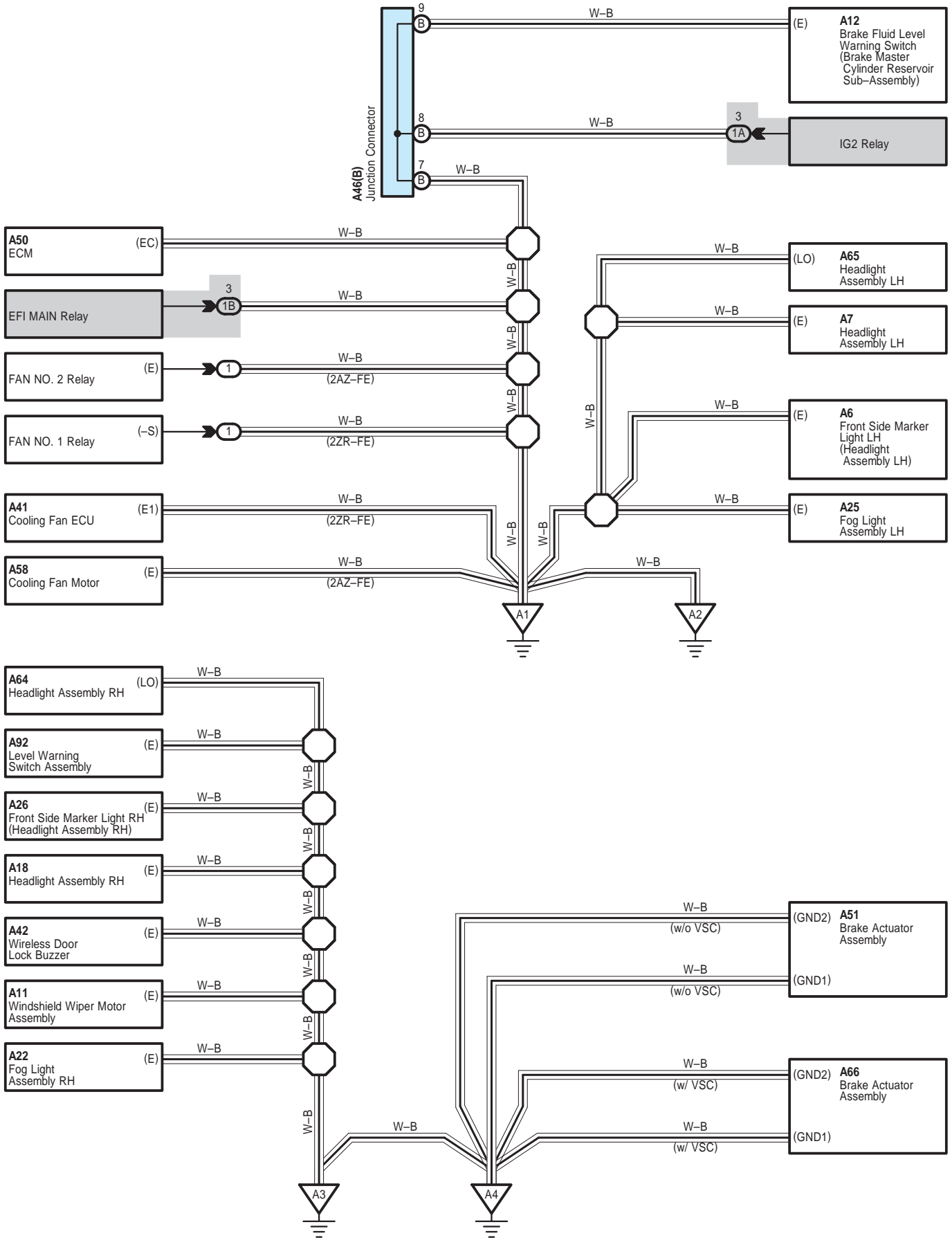



Ground Point <Except TMC Made>

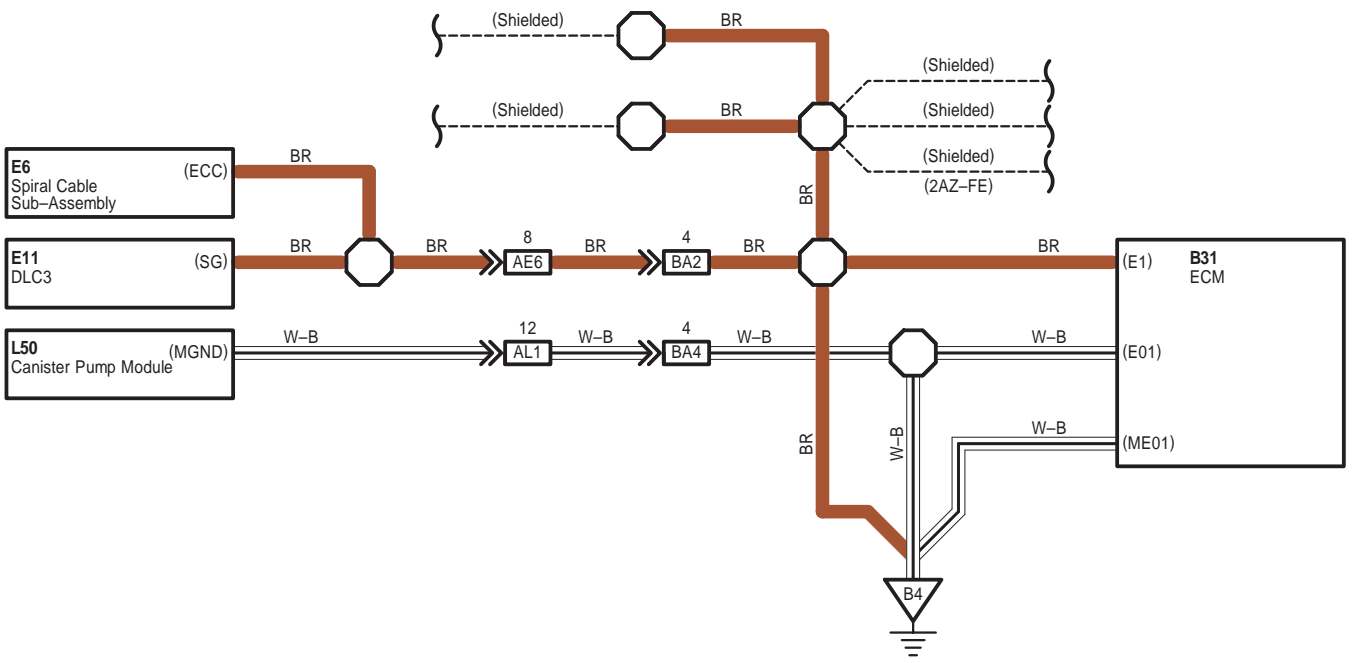
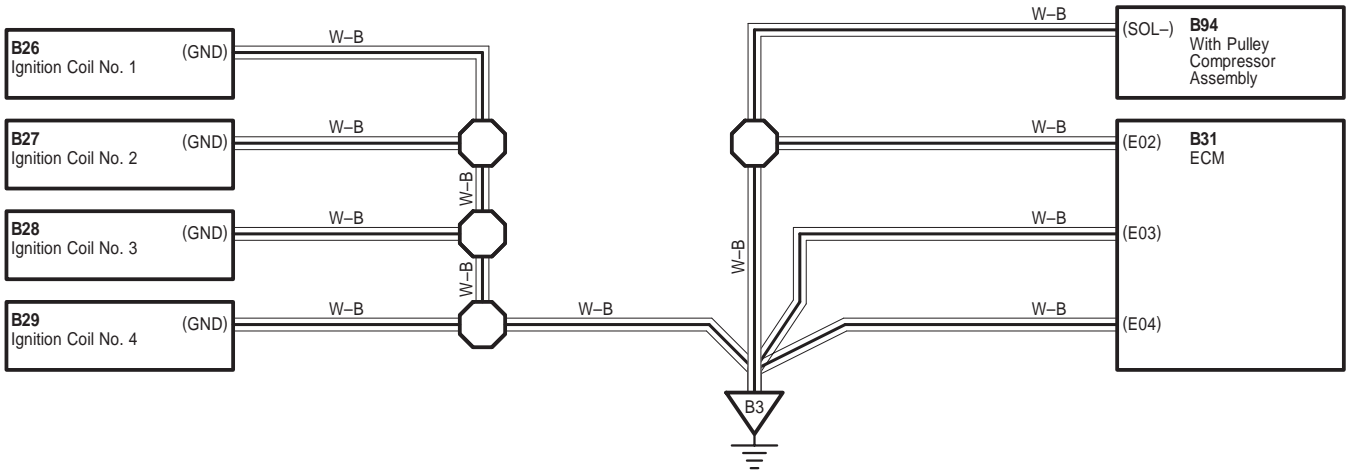
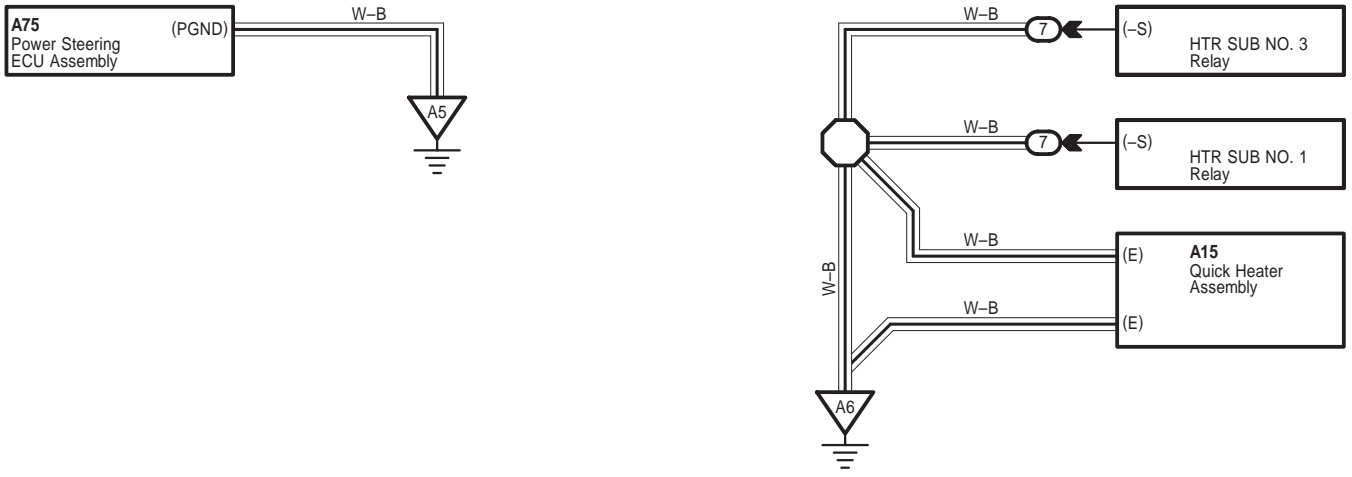

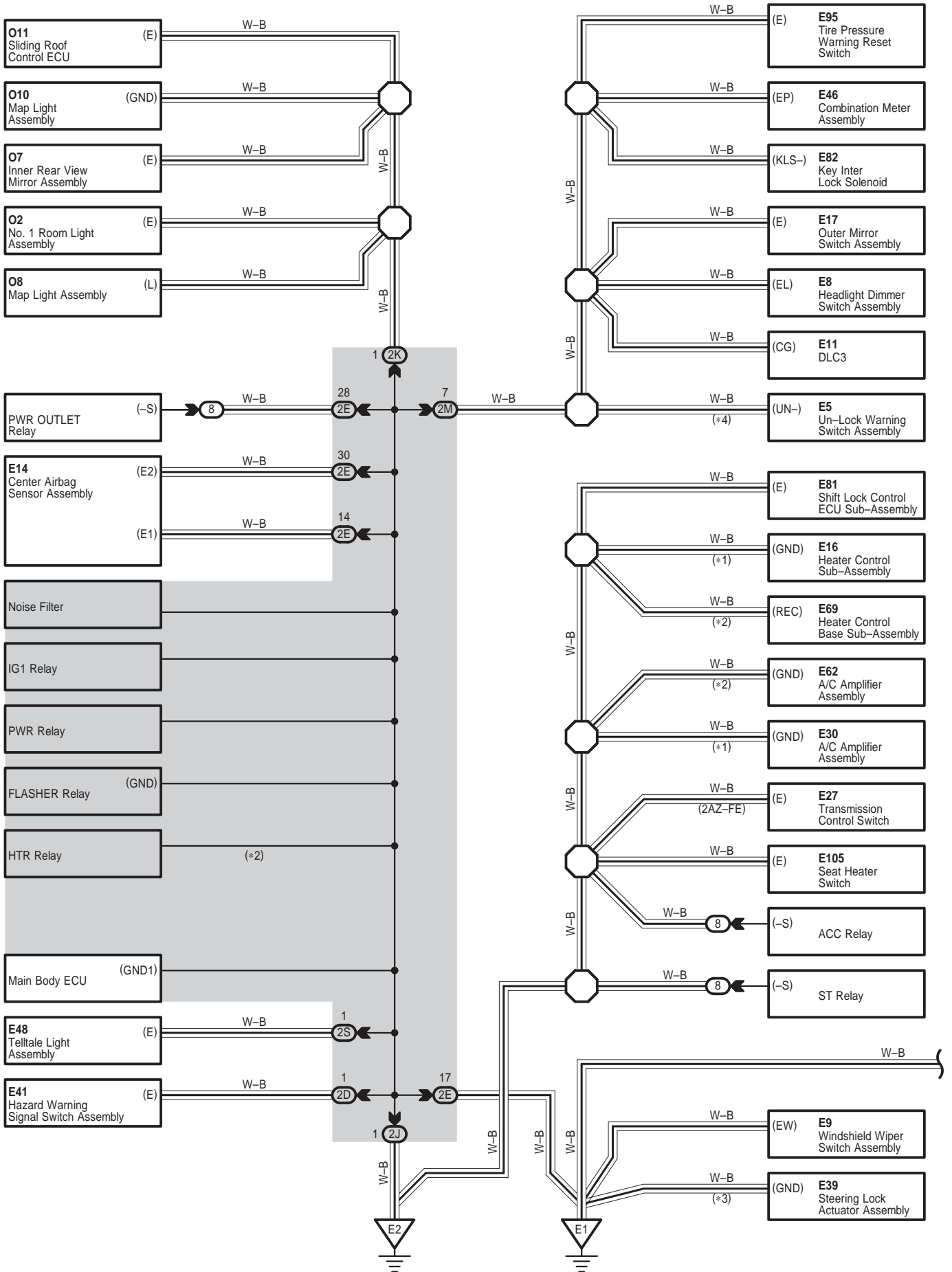

Ground Point <Except TMC Made>

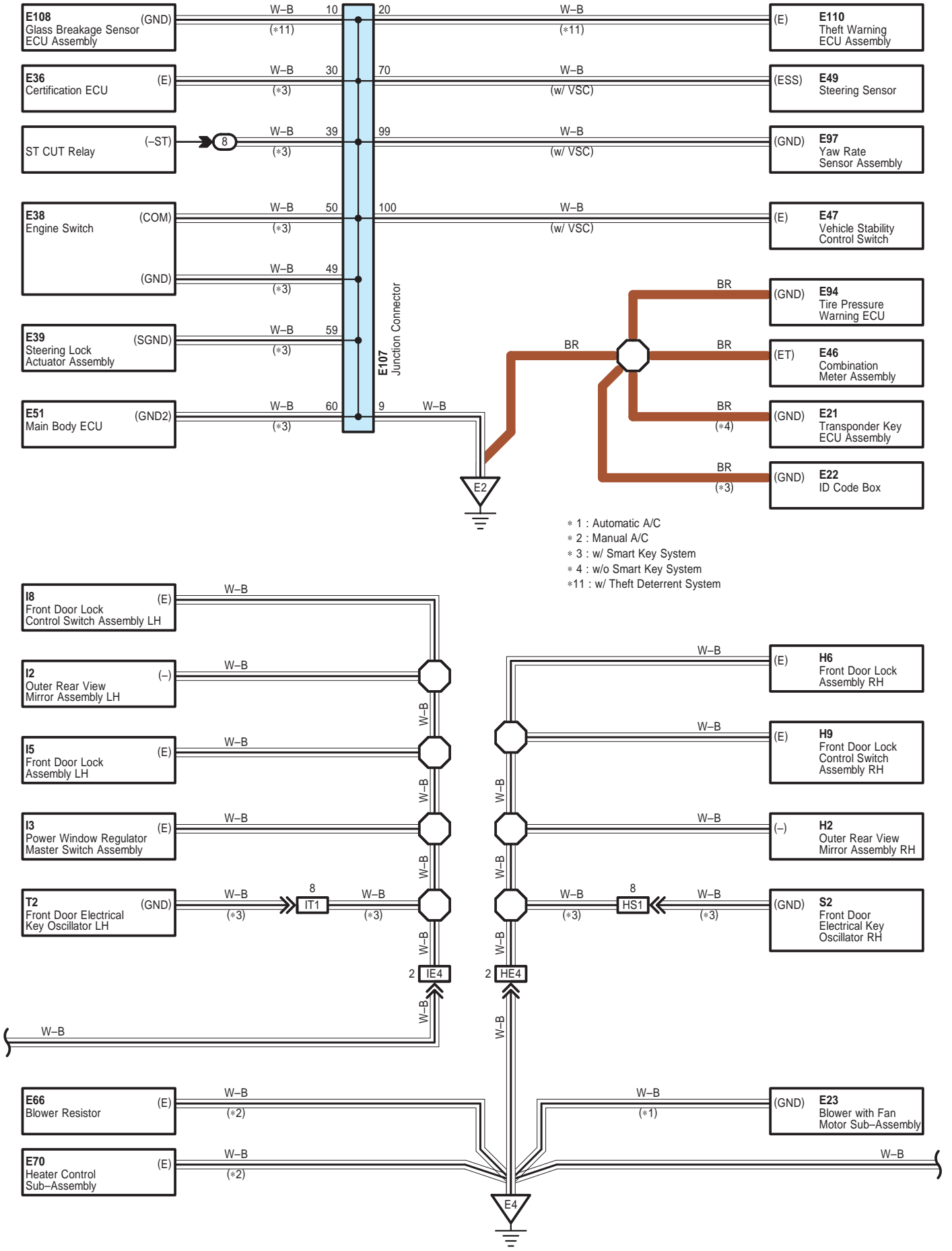

Ground Point <Except TMC Made>

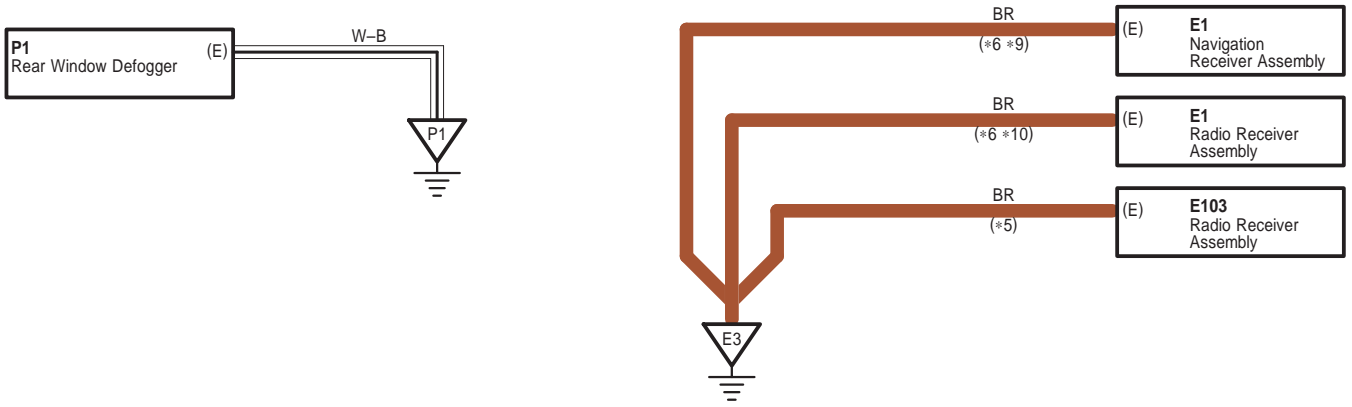

- \* 3 : w/ Smart Key System
- \* 4 : w/o Smart Key System
- \* 5 : Separate Type Amplifier
- \* 6 : Built-In Type Amplifier
- \* 7 : w/ Rear Spoiler
- \* 8 : w/o Rear Spoiler
- \* 9 : w/ Navigation System
- \* 10 : w/o Navigation System

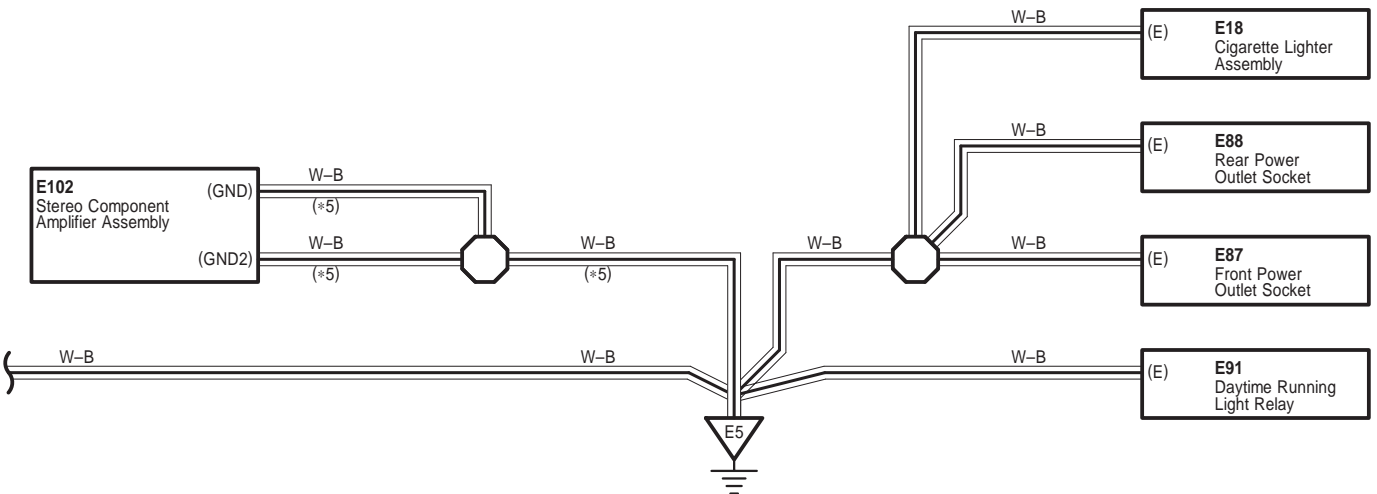
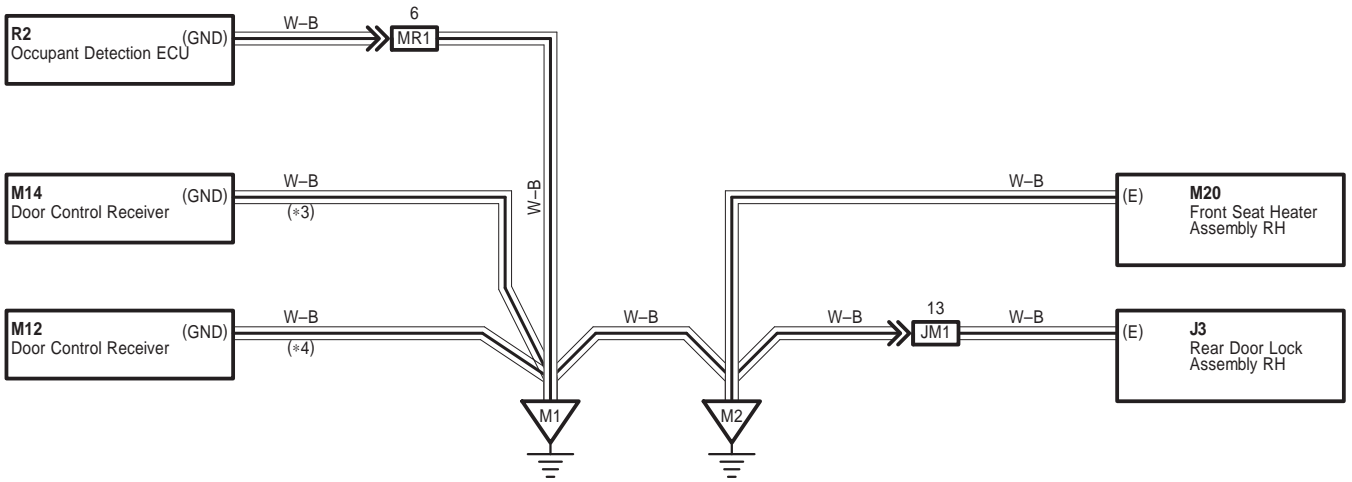

**Ground Point <Except TMC Made>**

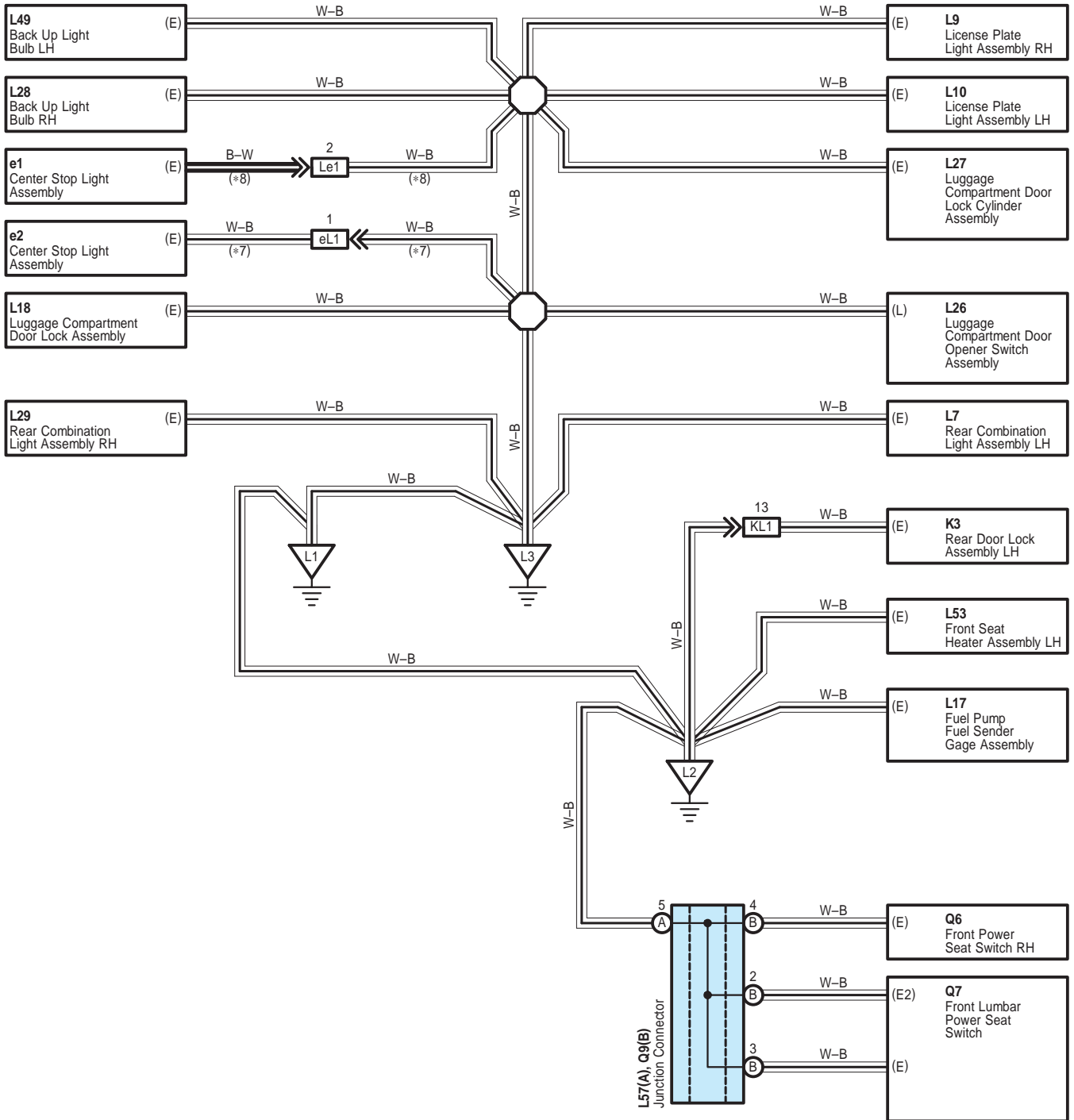

Ground Point <Except TMC Made>

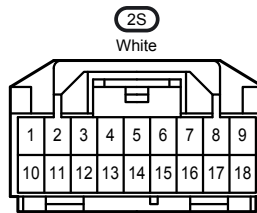
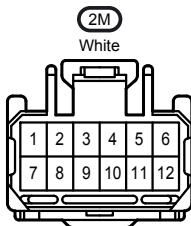
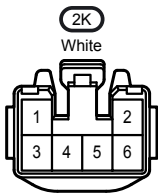
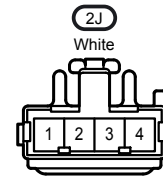
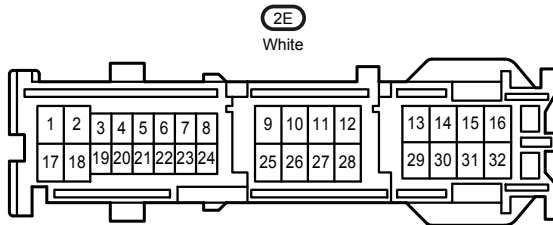
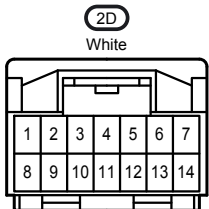
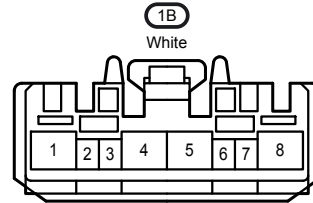
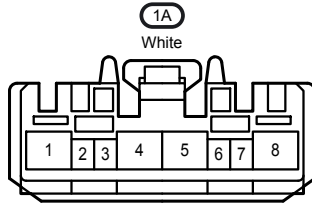
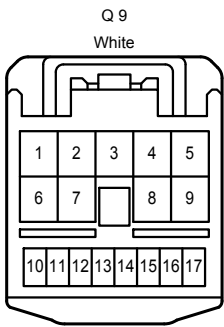
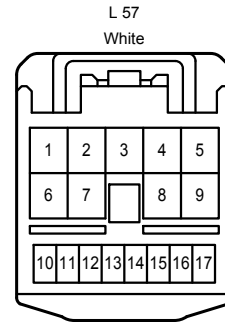
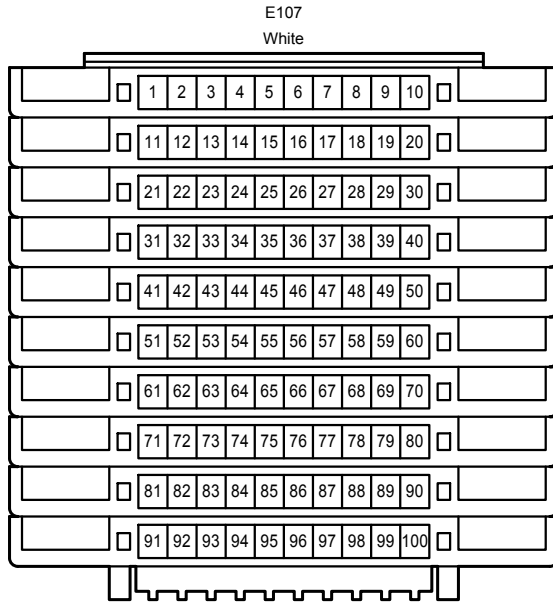
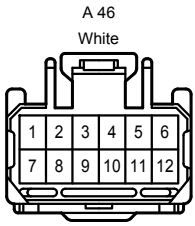

AE6  
Gray

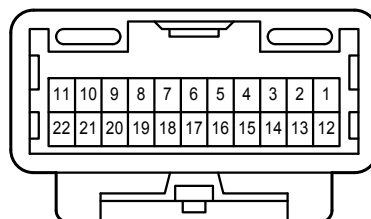
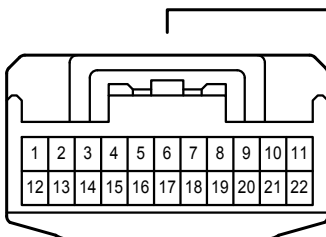

Ground Point <Except TMC Made>

AL1  
White

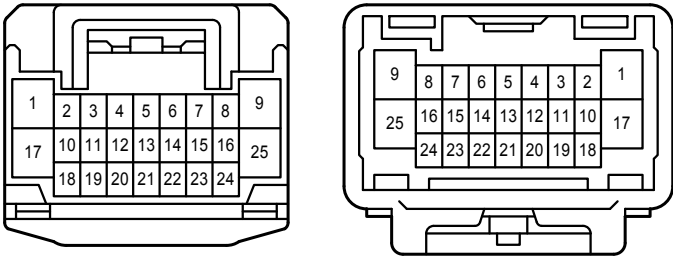

BA2  
White

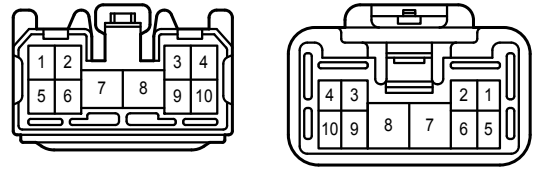

BA4  
Gray

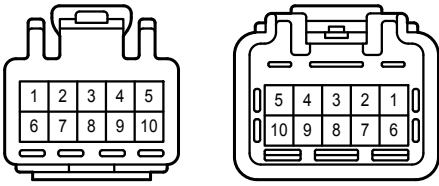

HE4  
White

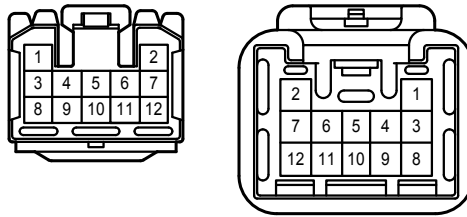

HS1  
Gray

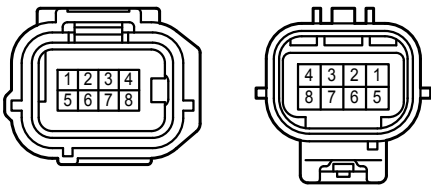

IE4  
White

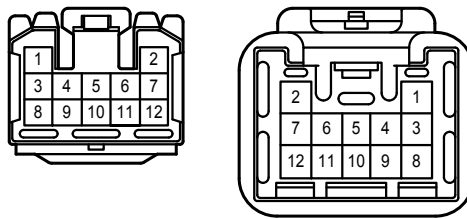

IT1  
Gray

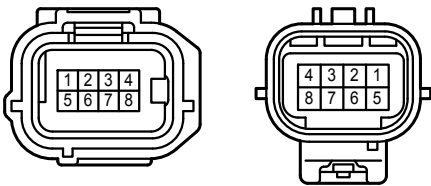

JM1  
White

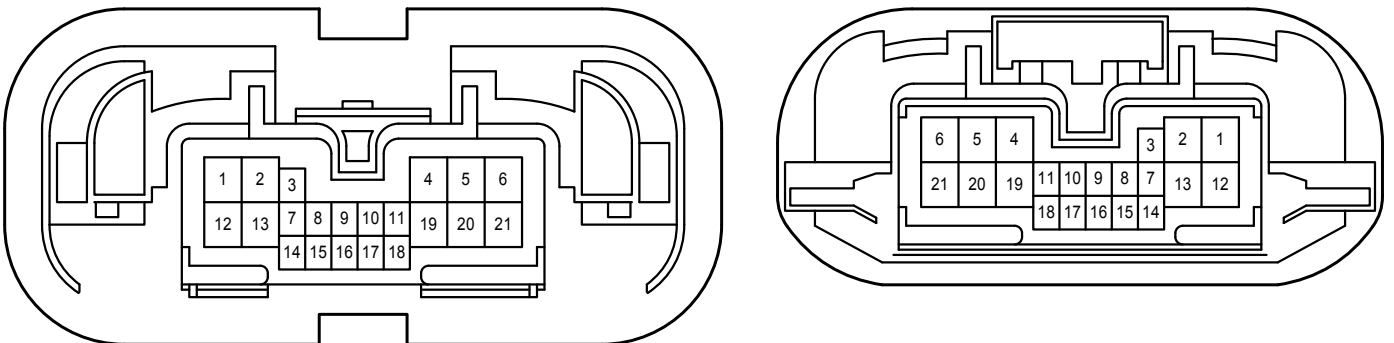

Ground Point <Except TMC Made>

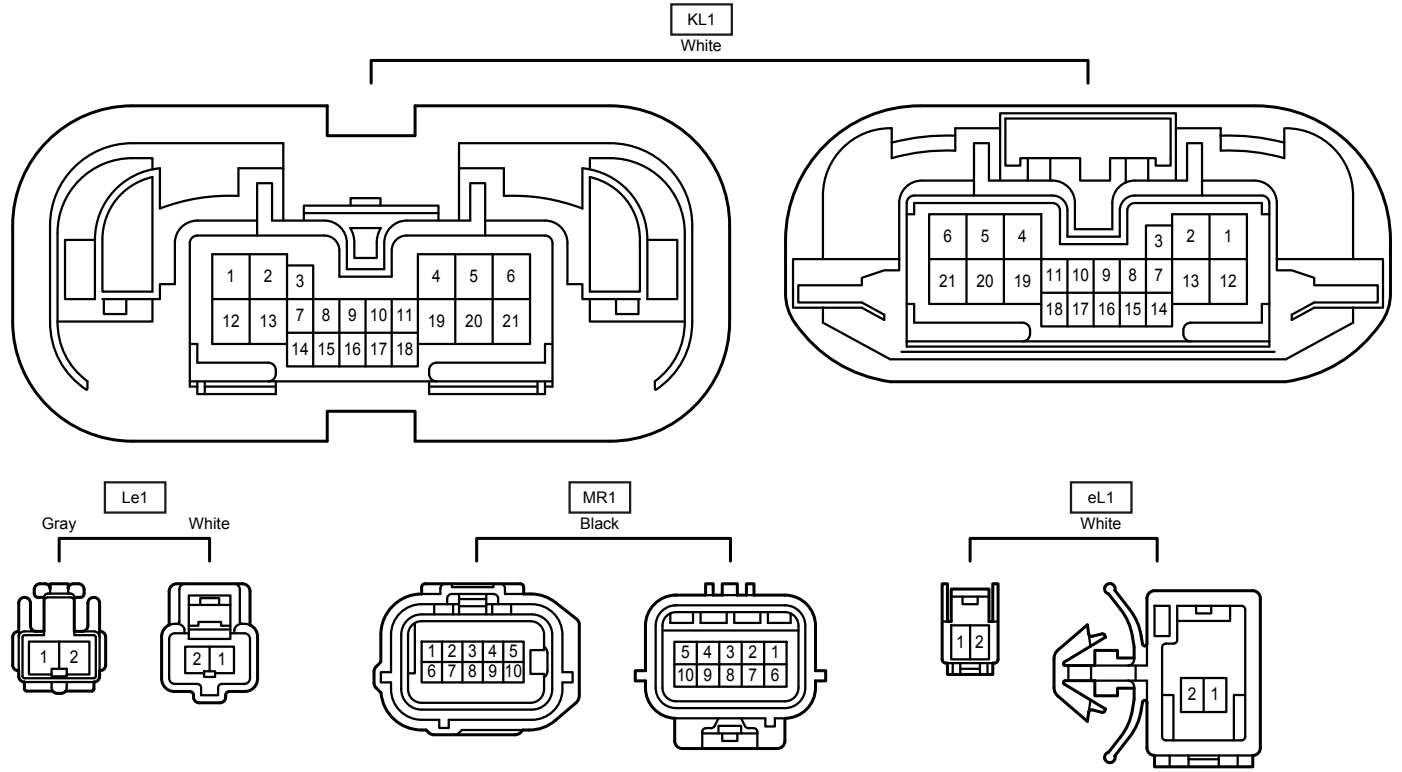



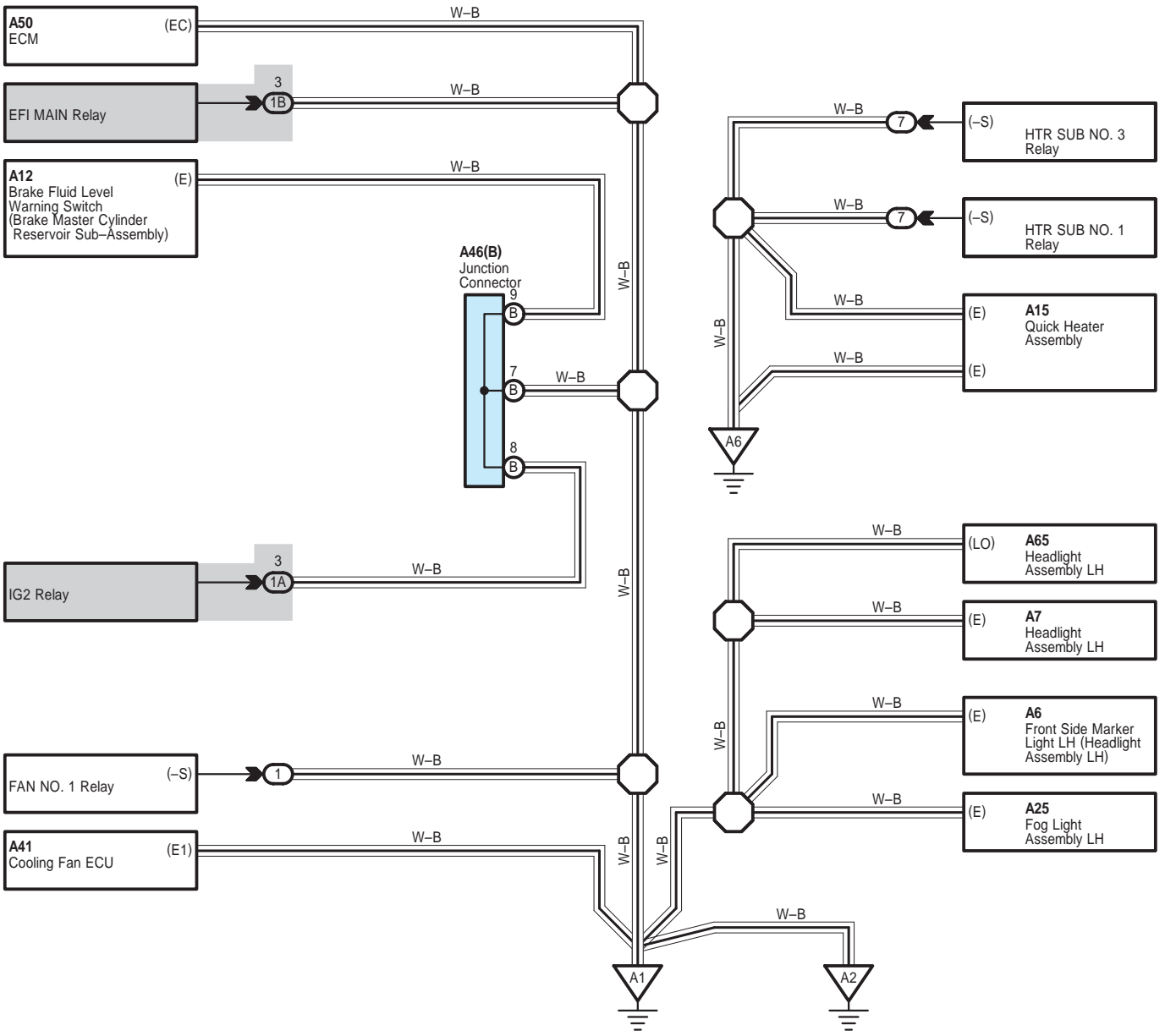

Ground Point <TMC Made>

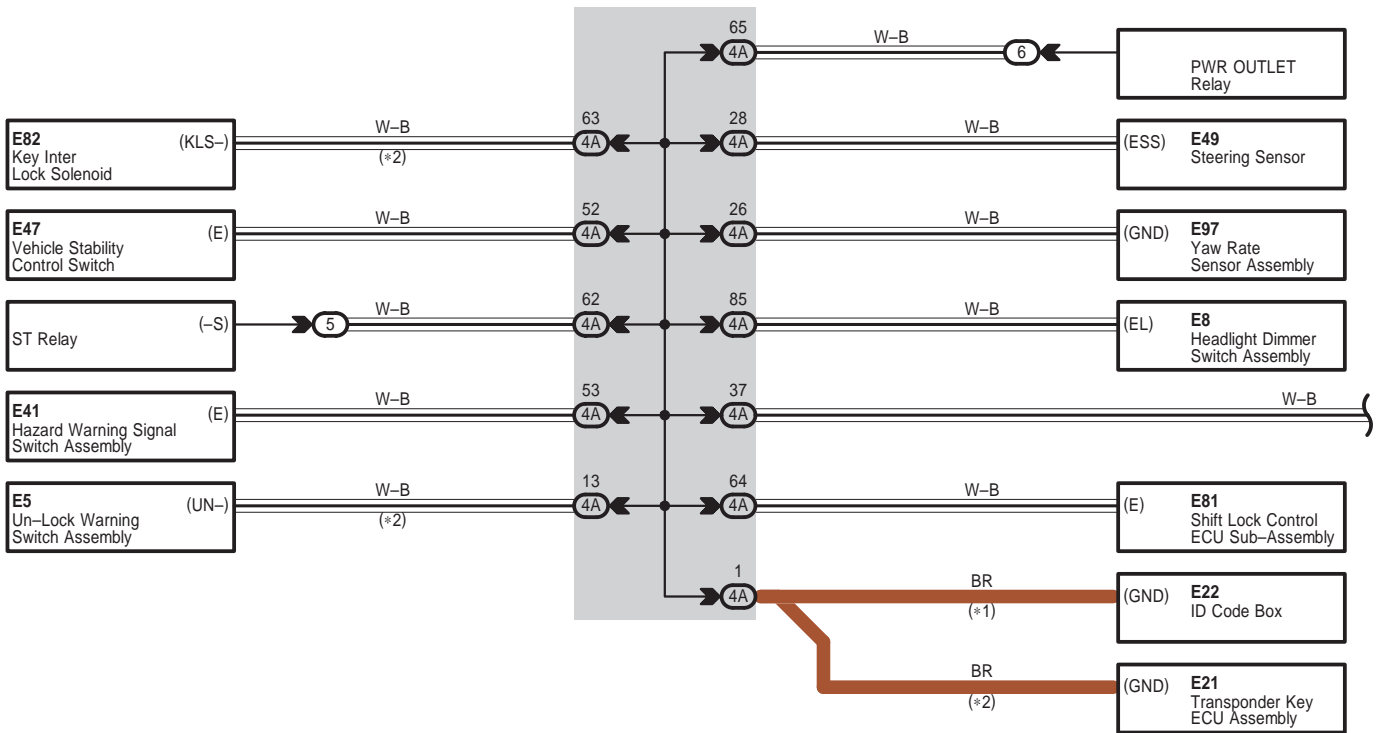

\* 1 : w/ Smart Key System  
 \* 2 : w/o Smart Key System

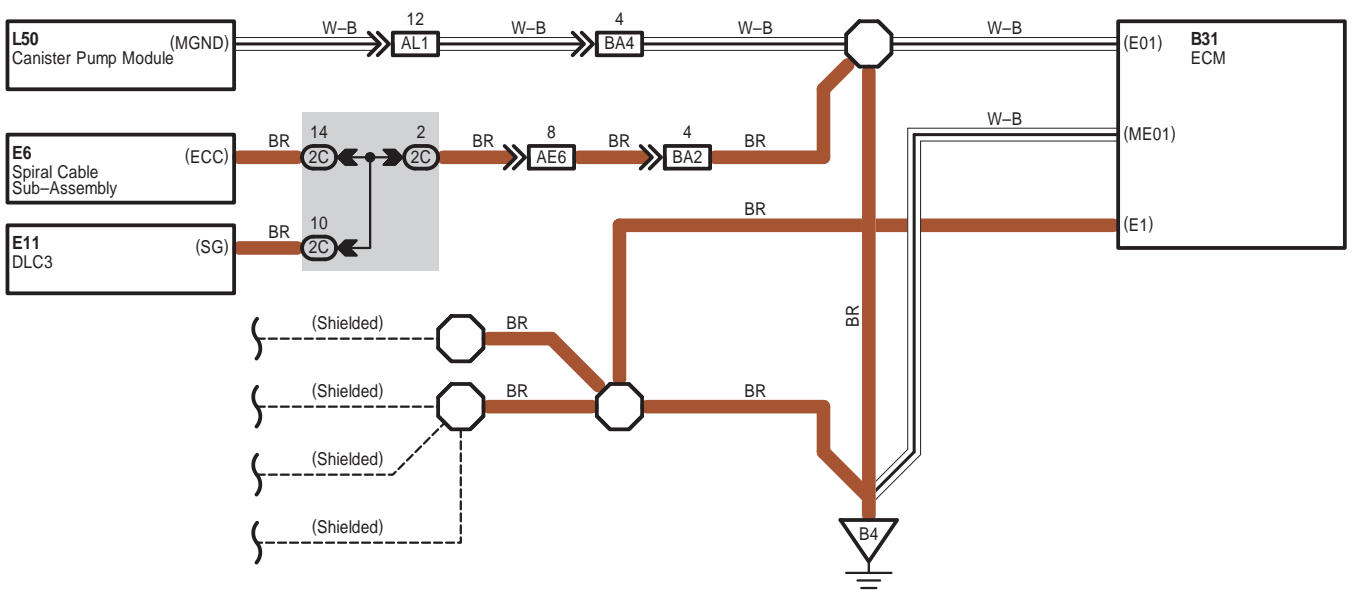

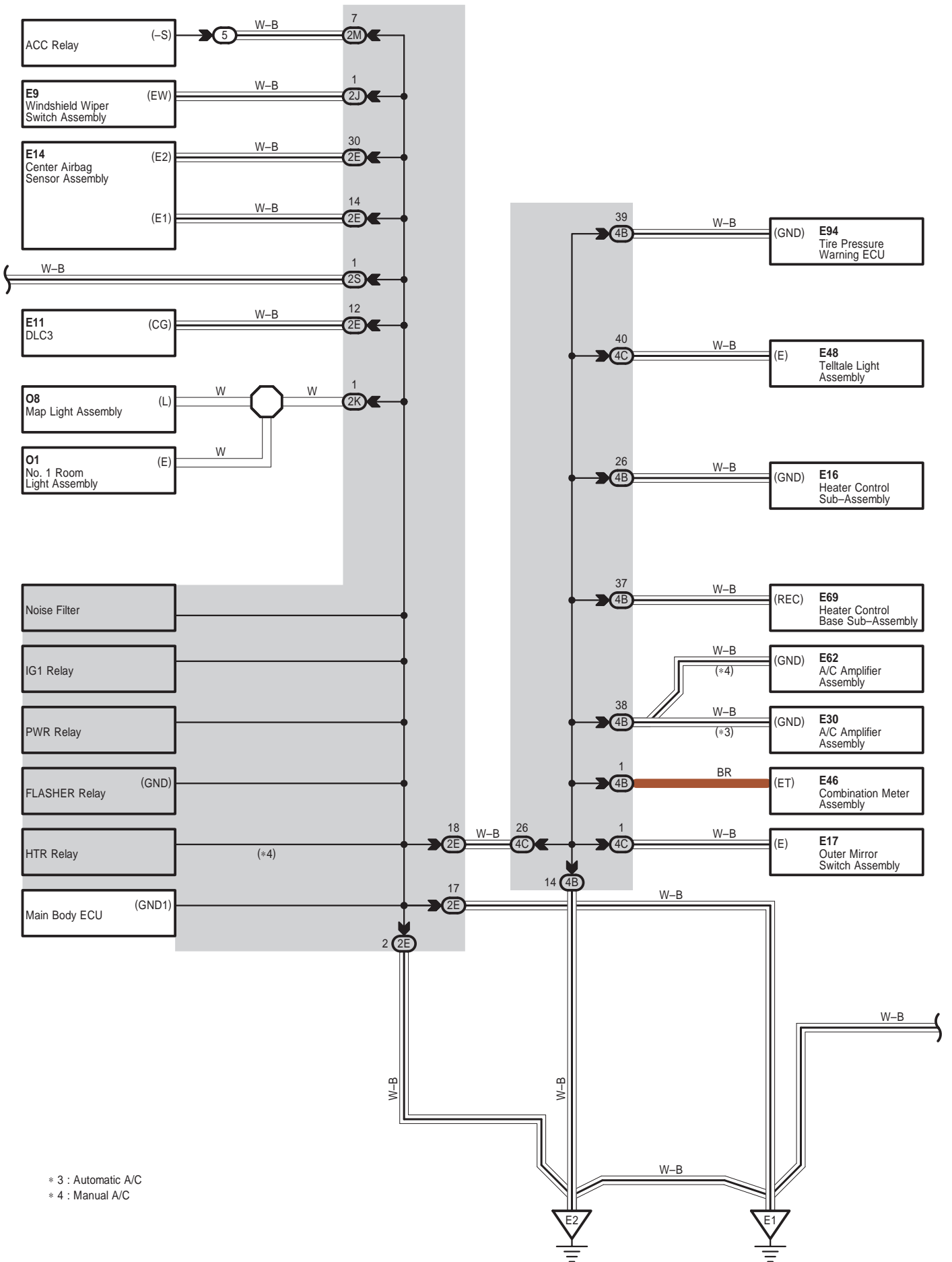

\* 3 : Automatic A/C  
 \* 4 : Manual A/C

Ground Point <TMC Made>

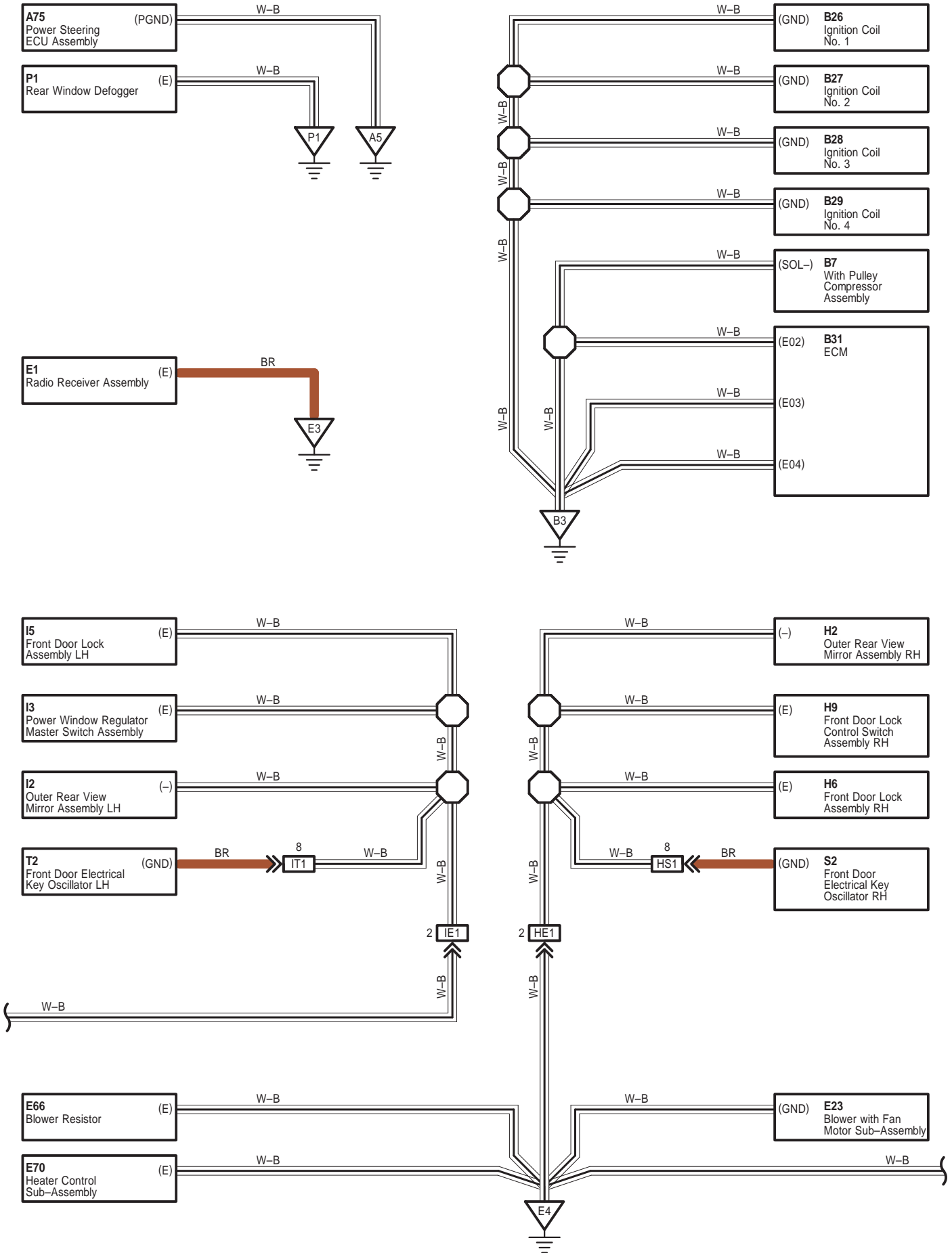

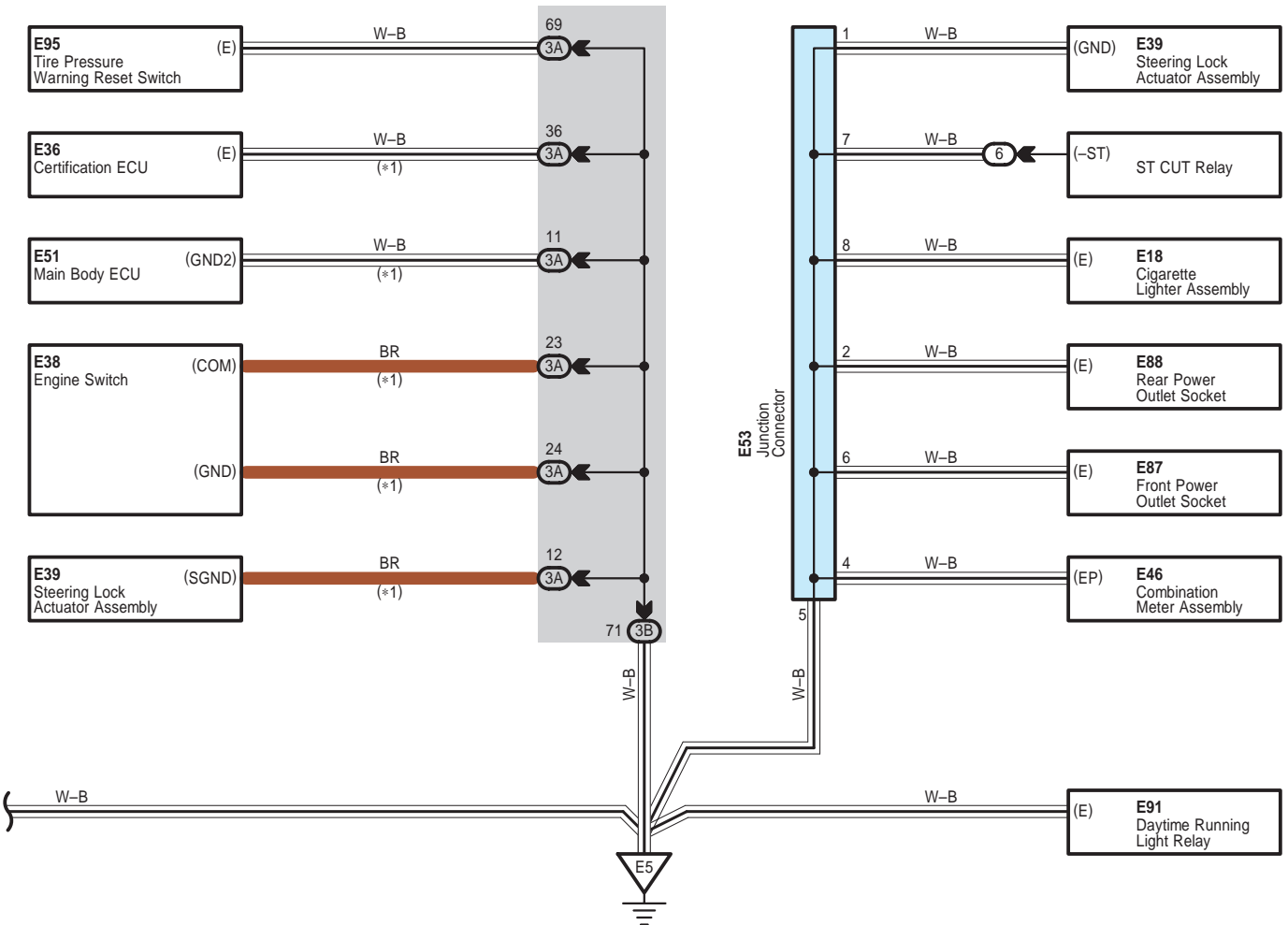
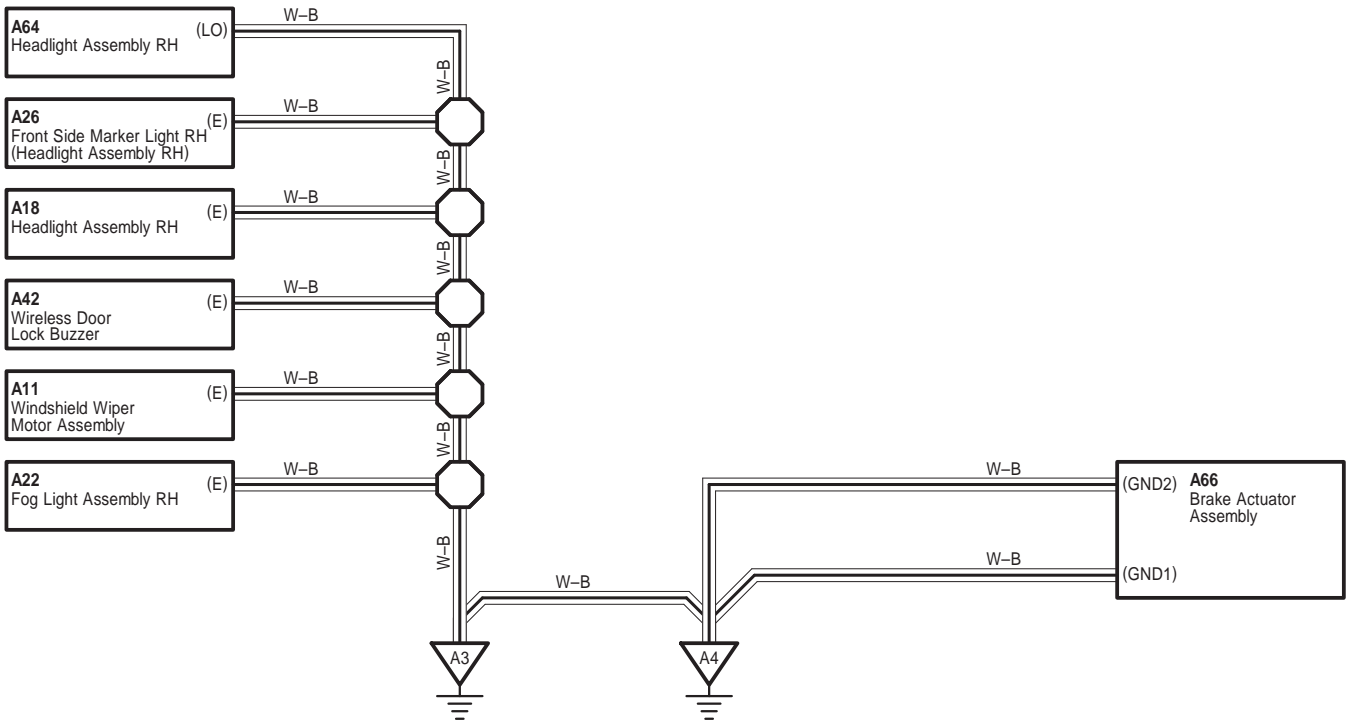

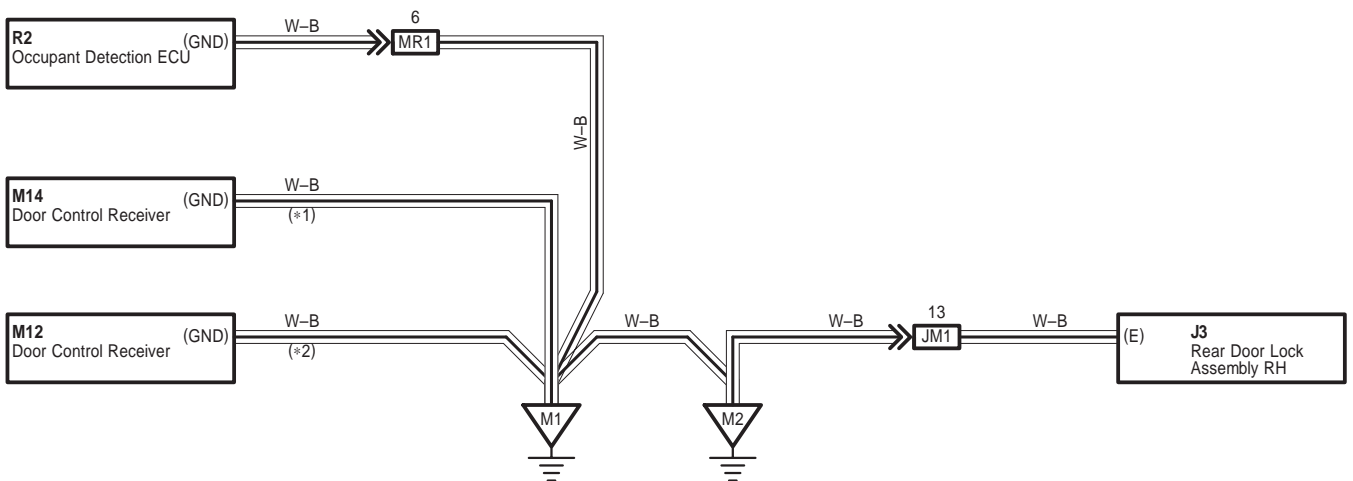
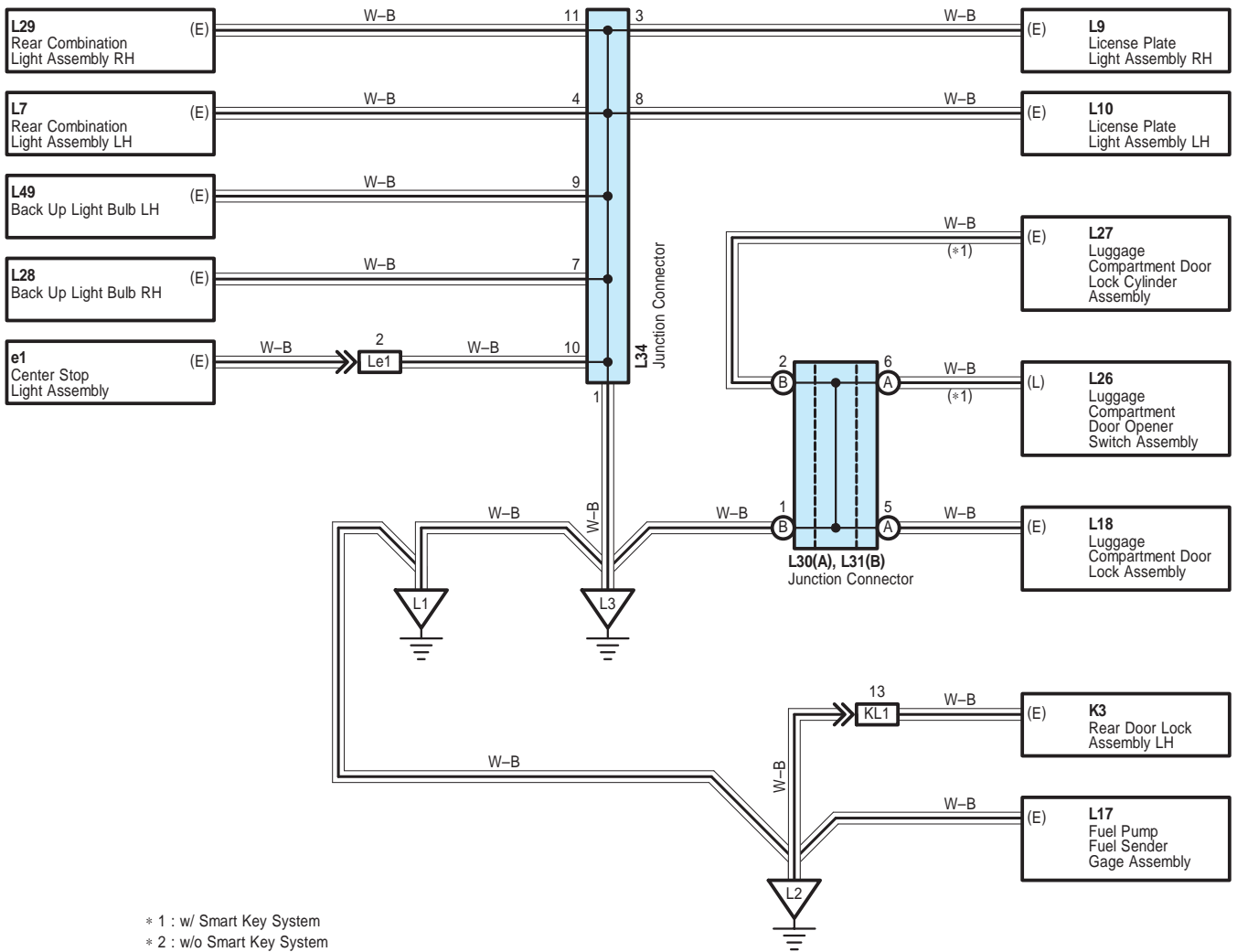

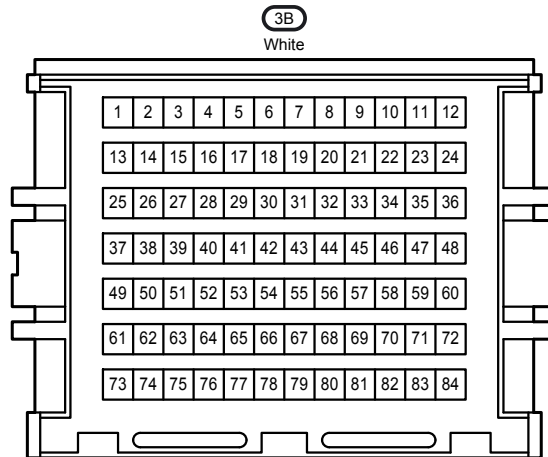
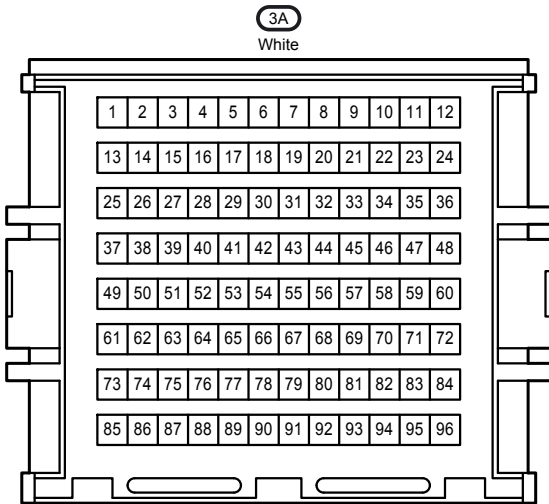
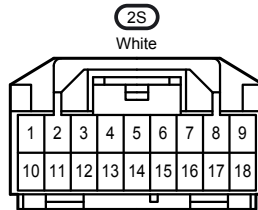
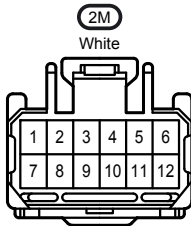
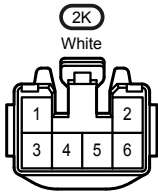
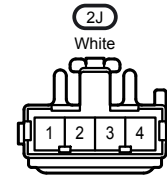
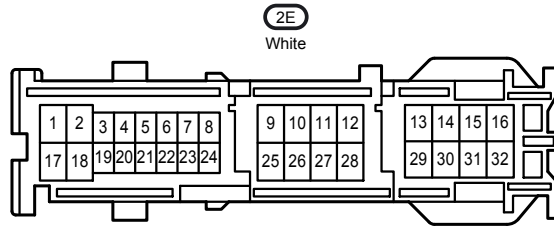
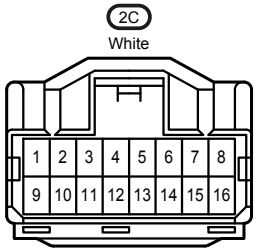
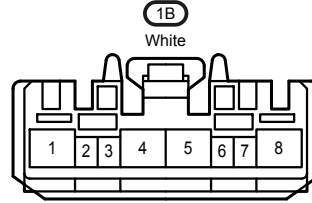
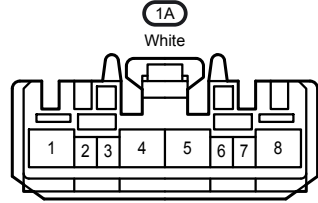
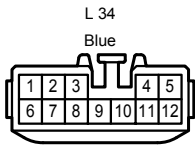
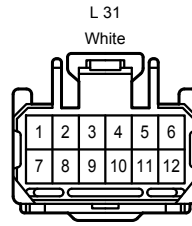
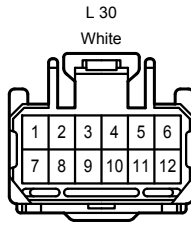
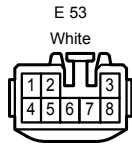
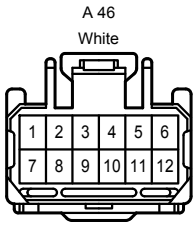

4A  
White

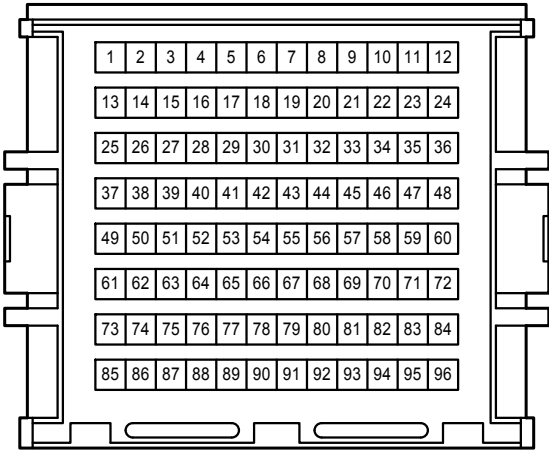

4B  
White

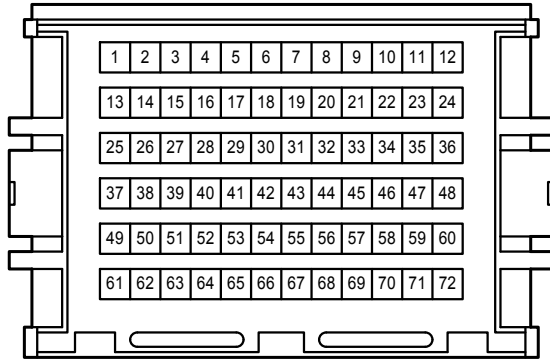

4C  
White

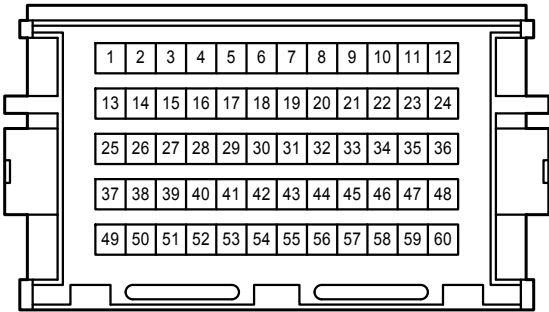

AE6  
Gray

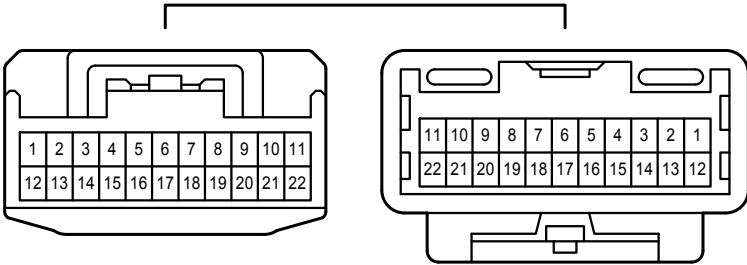

AL1  
White

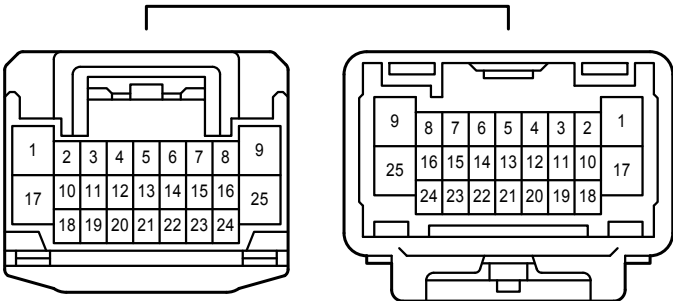

BA2  
White

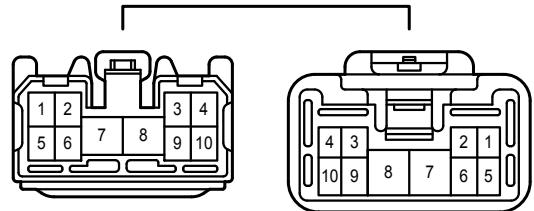



BA4  
Gray

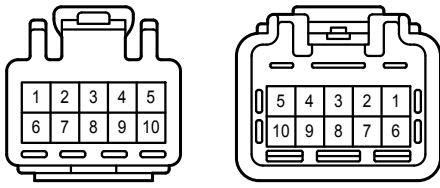

HE1  
Blue

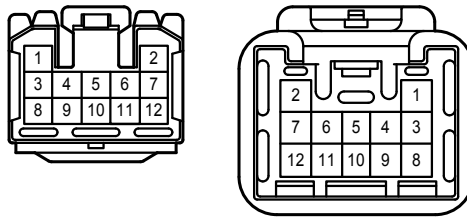

HS1  
Gray

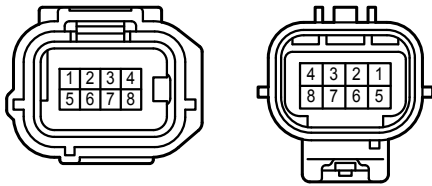

IE1  
Blue

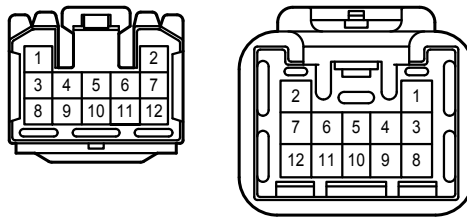

IT1  
Gray

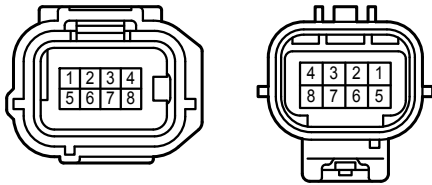

JM1  
White

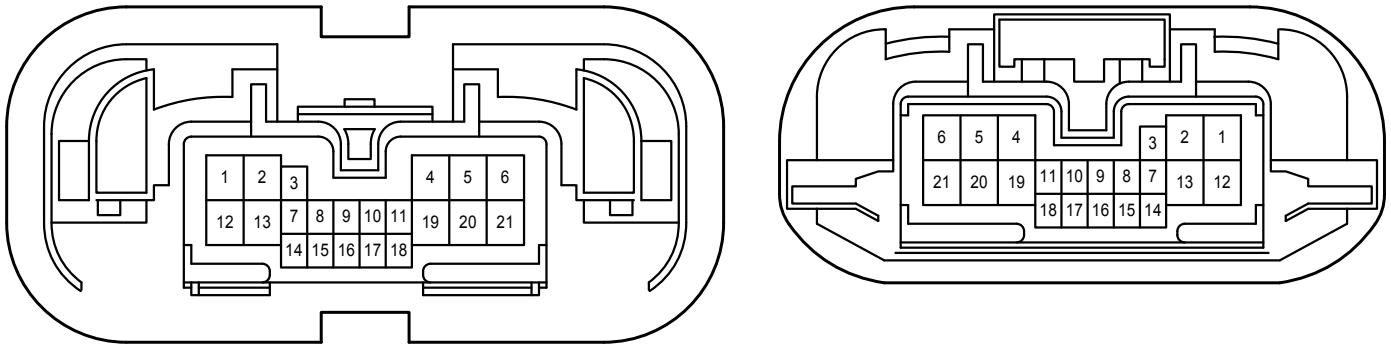

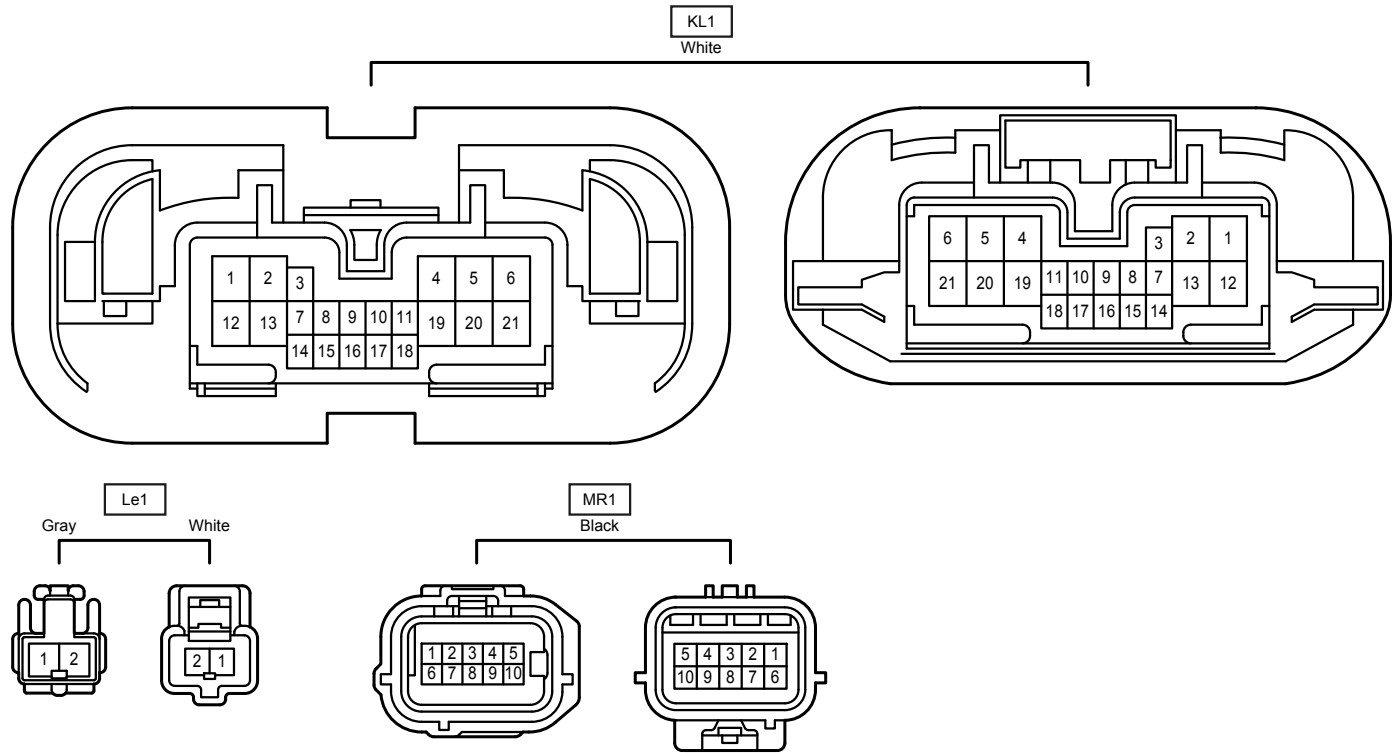

Headlight <Except TMC Made>

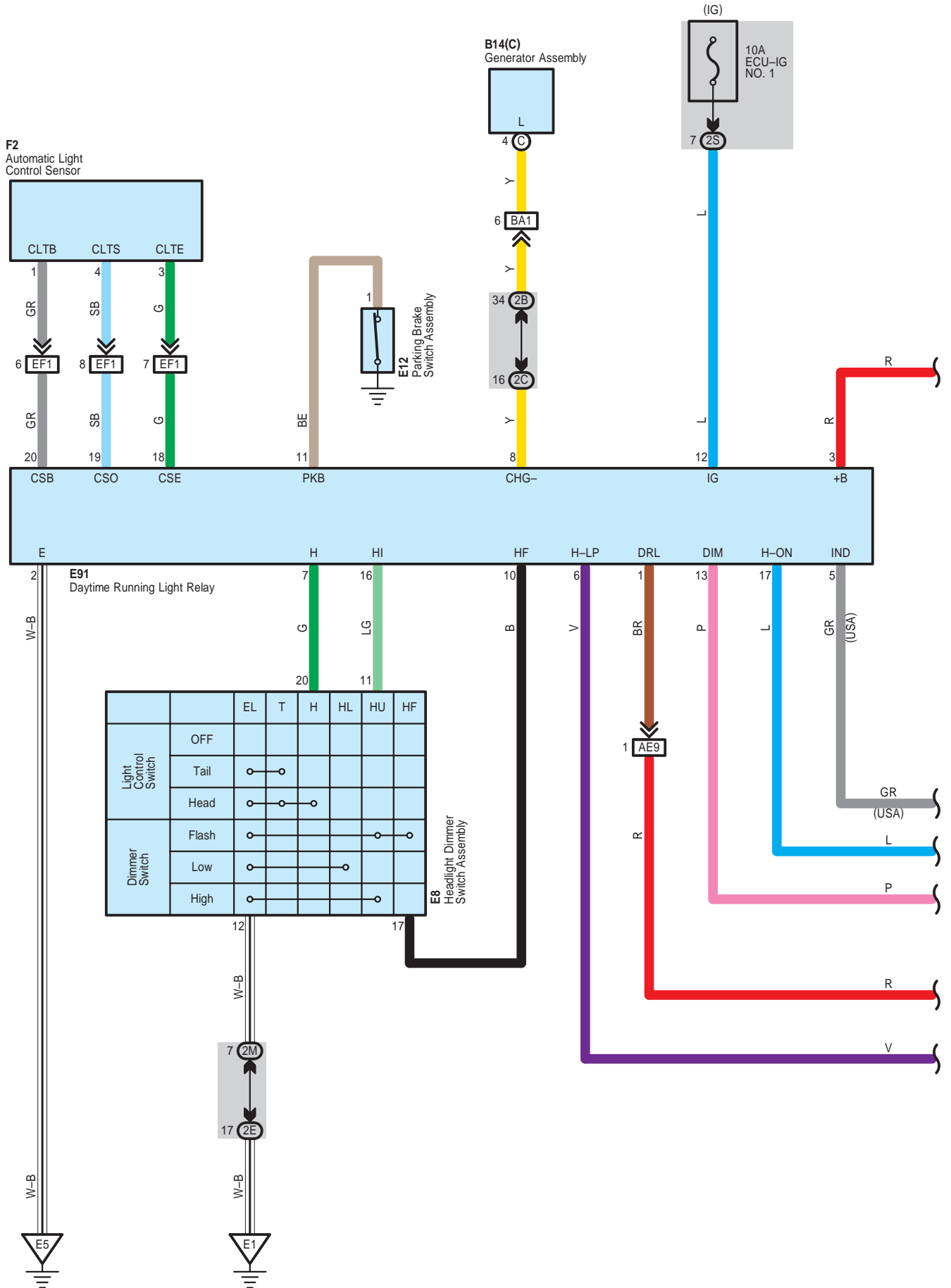

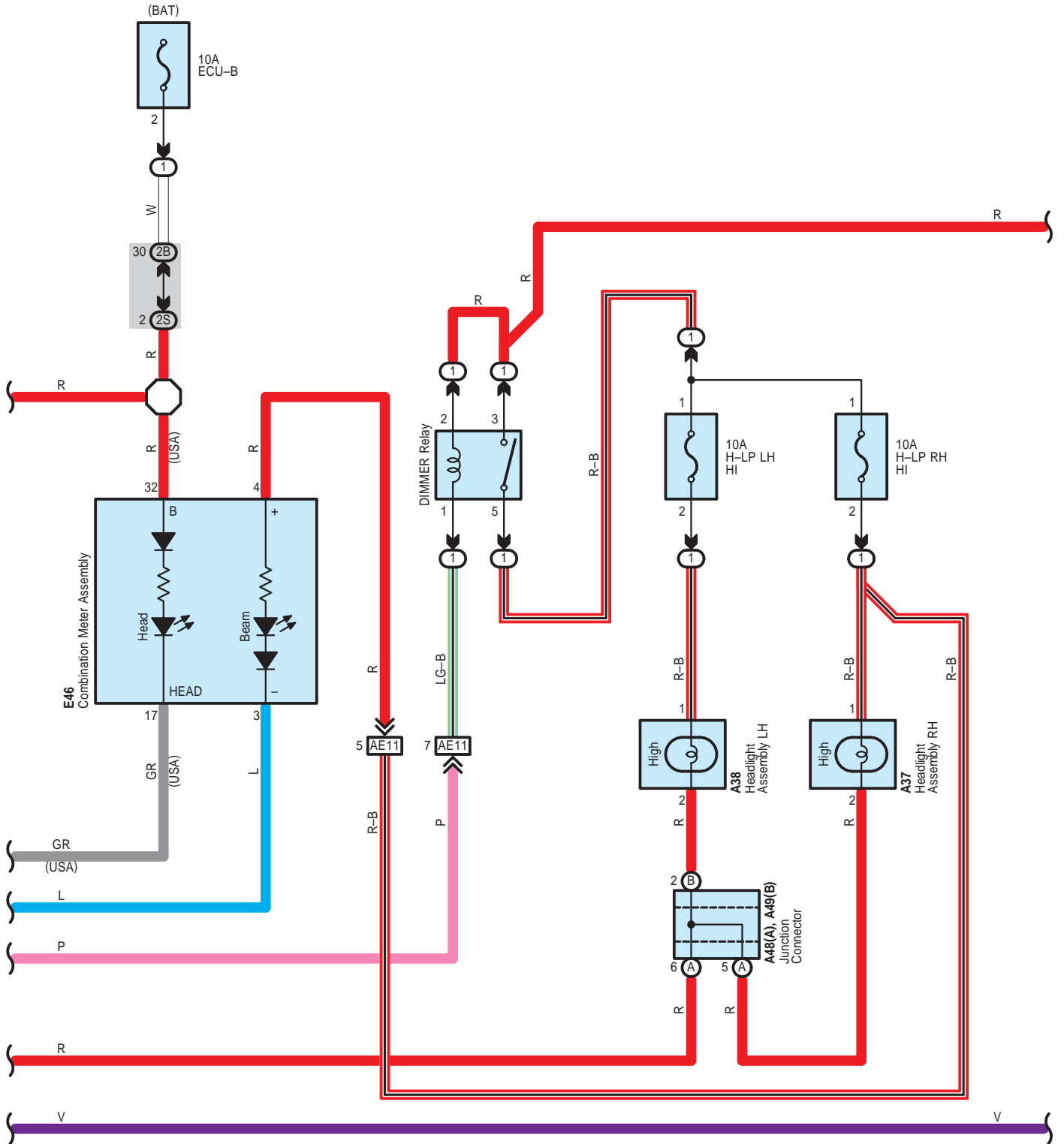

Headlight <Except TMC Made>

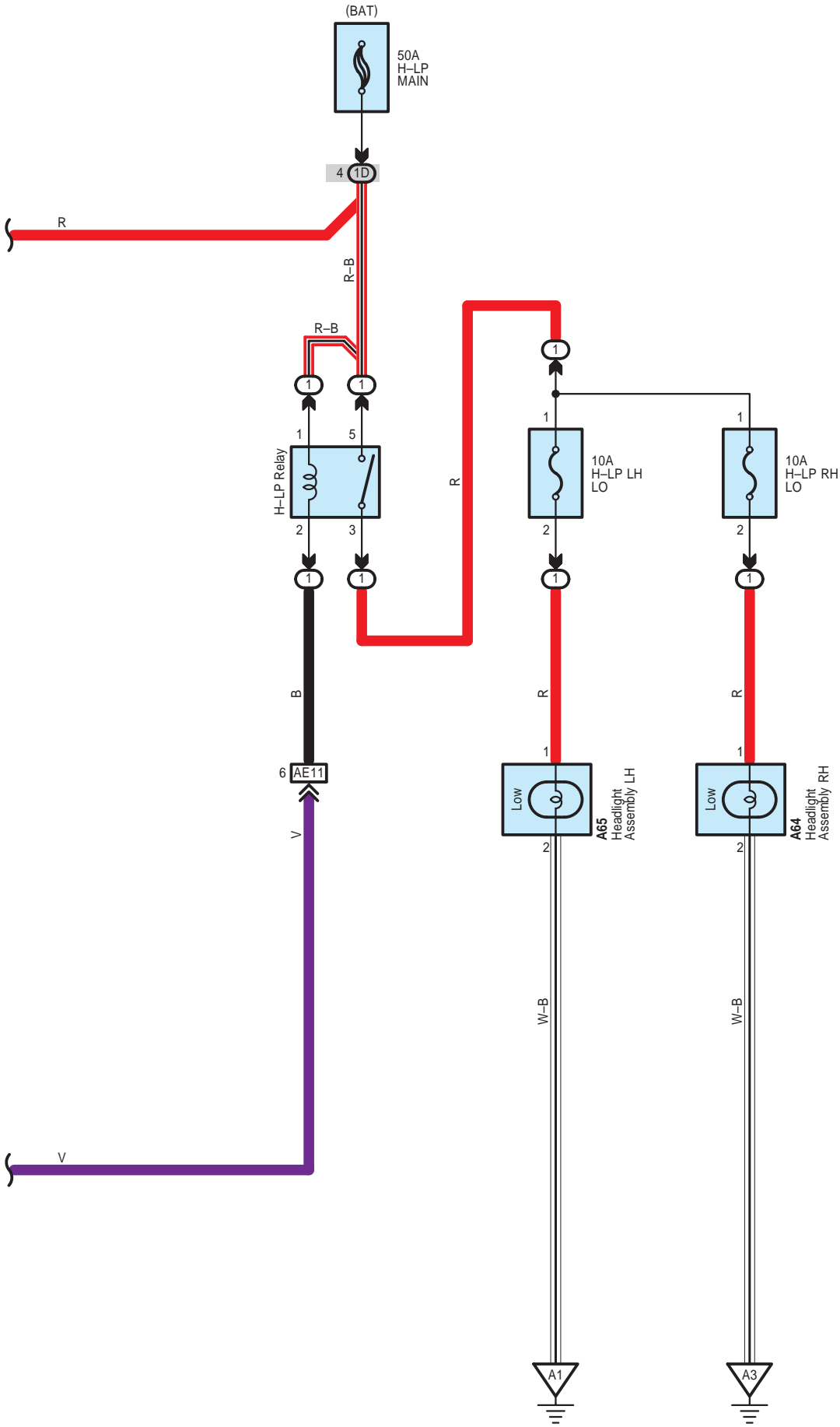

Headlight <Except TMC Made>

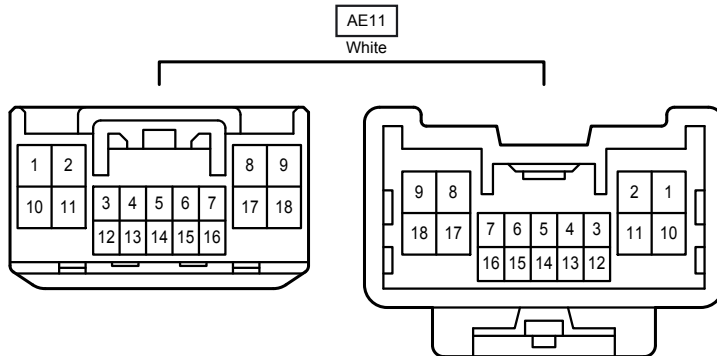
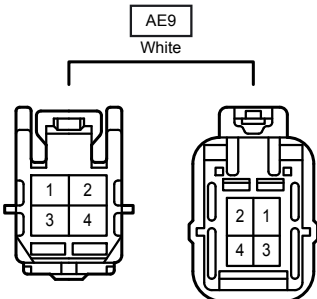
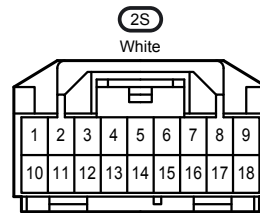
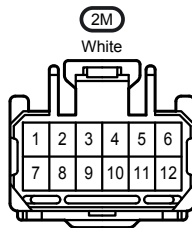
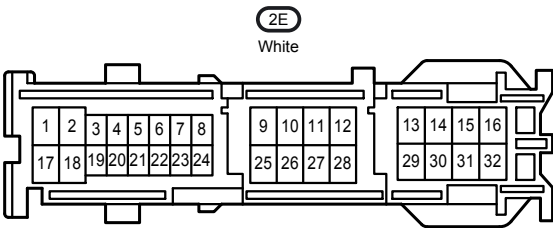
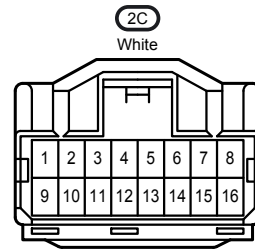
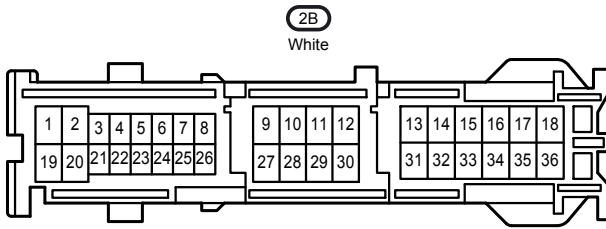
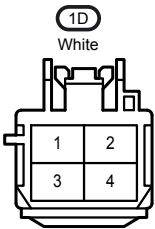
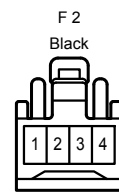
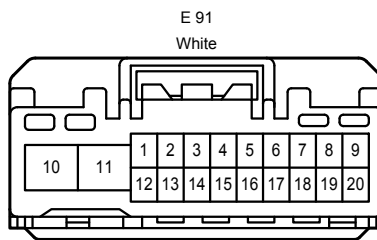
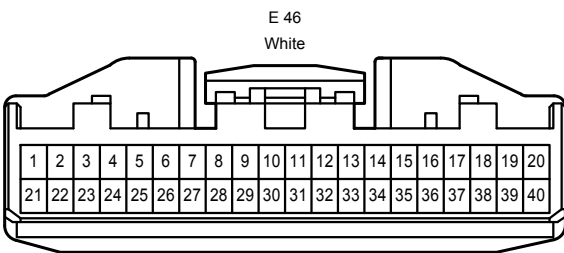
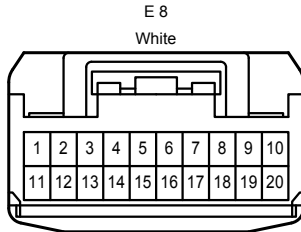
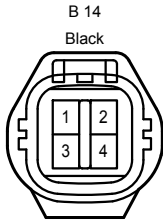
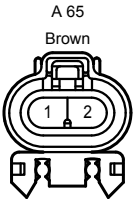
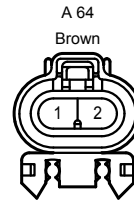
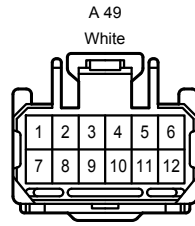
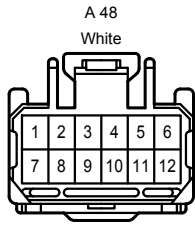
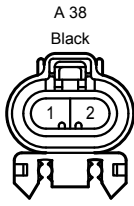
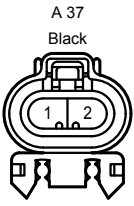

Headlight <Except TMC Made>

BA1  
White

EF1  
White

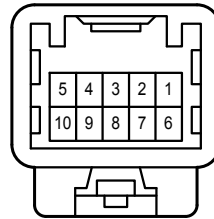
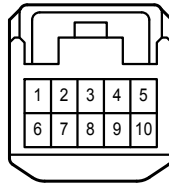
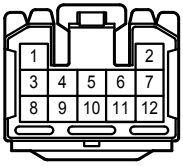

Headlight <TMC Made>

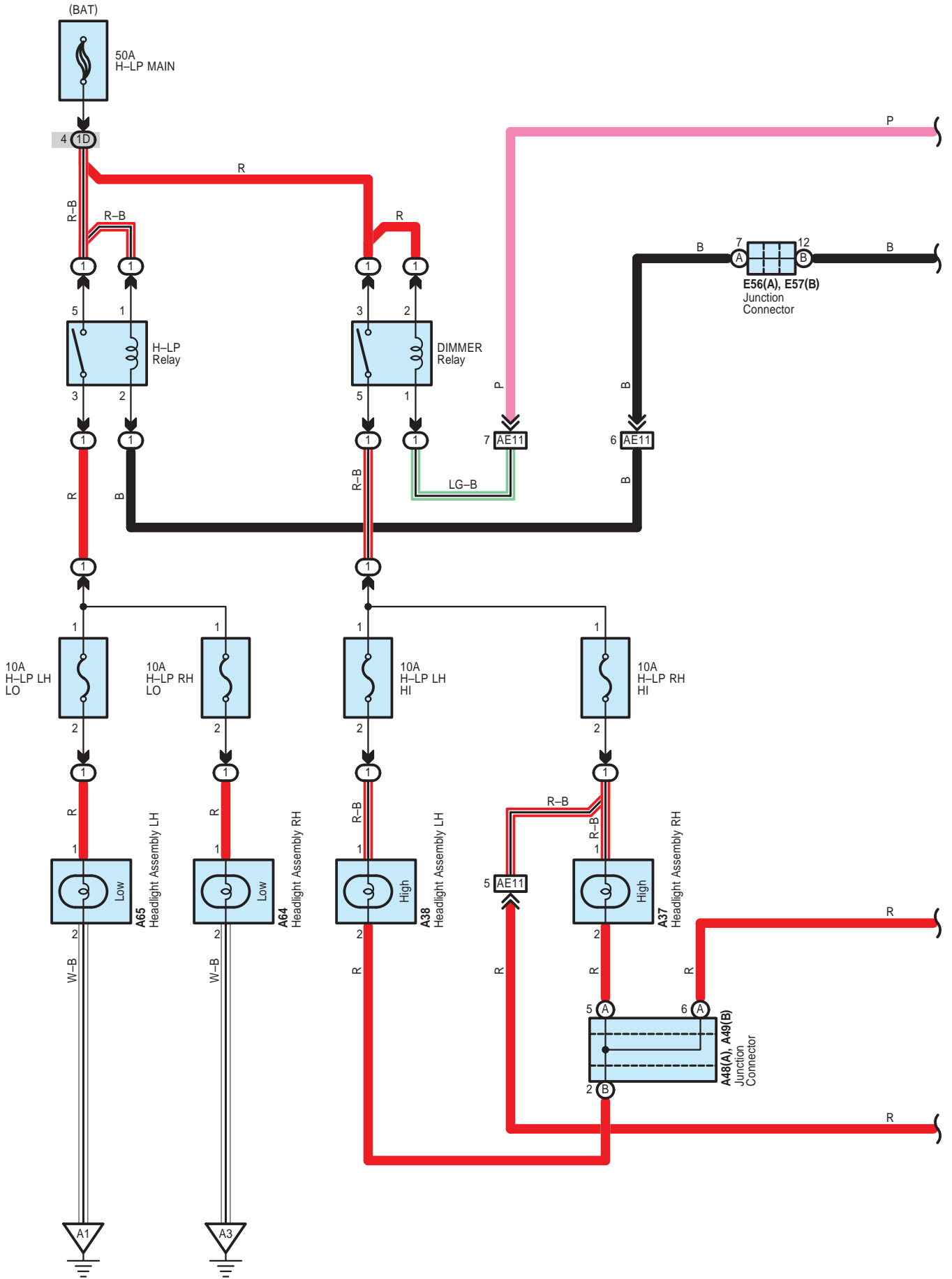



# Headlight <TMC Made>

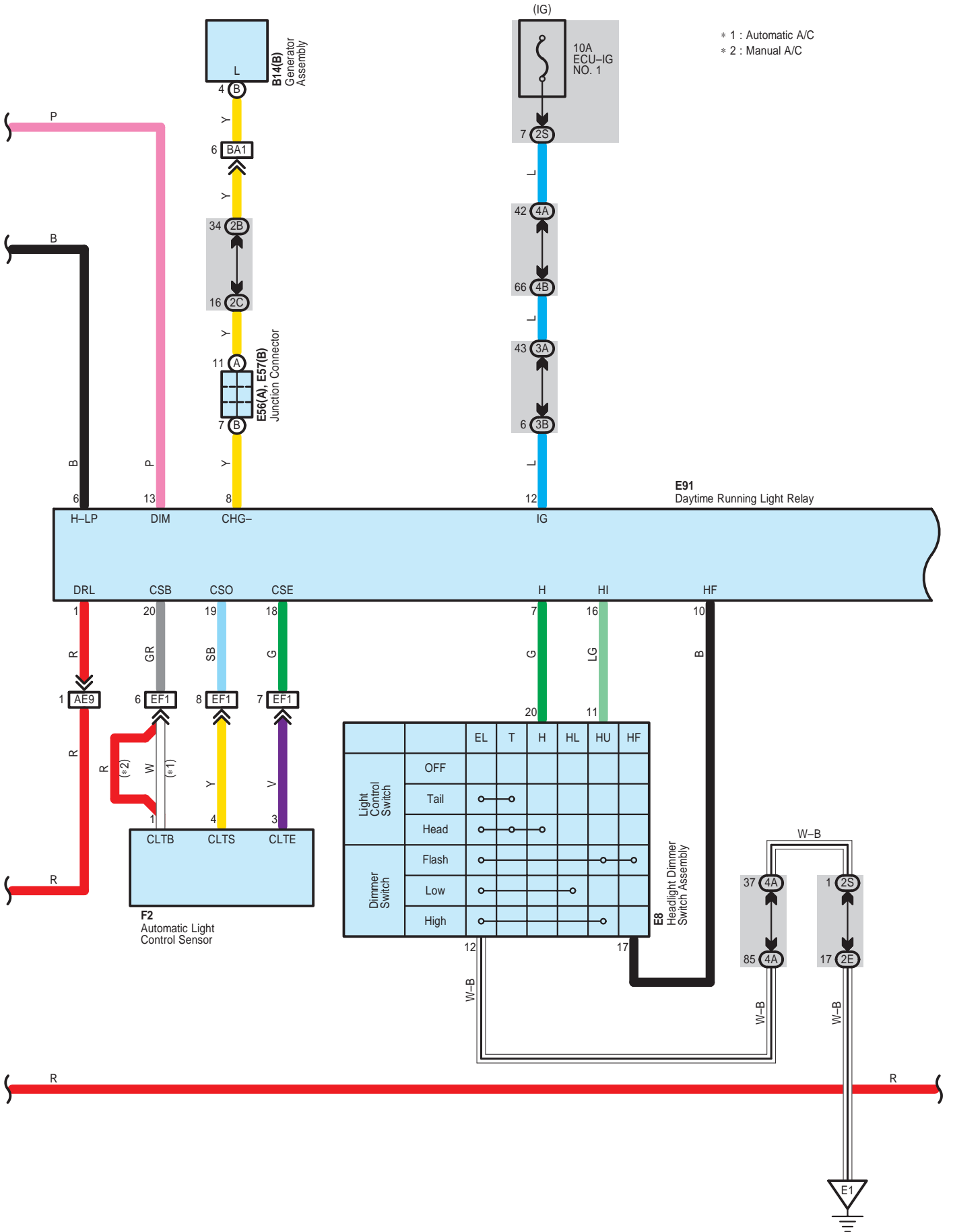

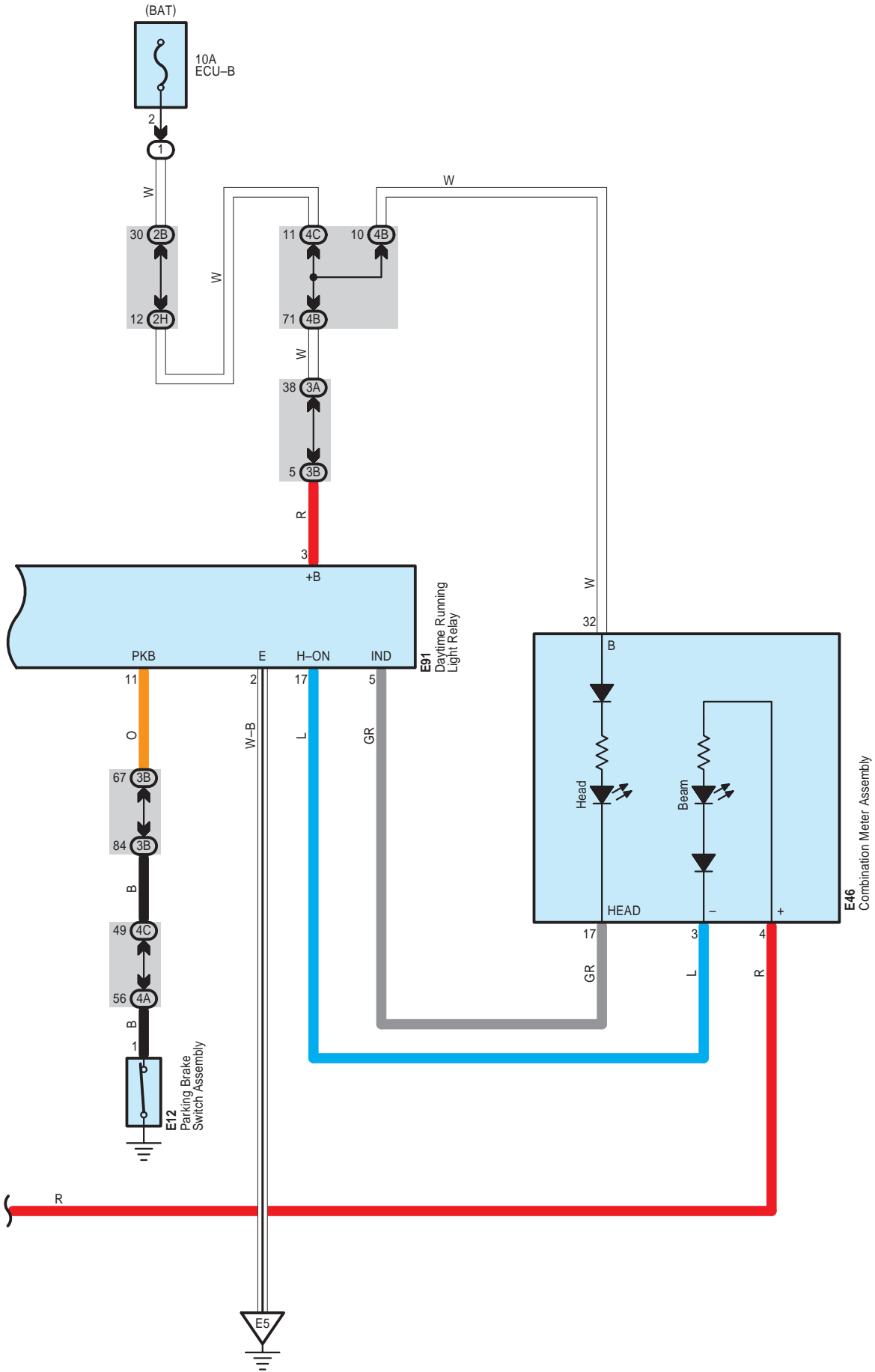

Headlight <TMC Made>

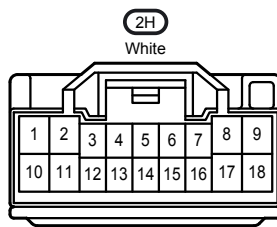
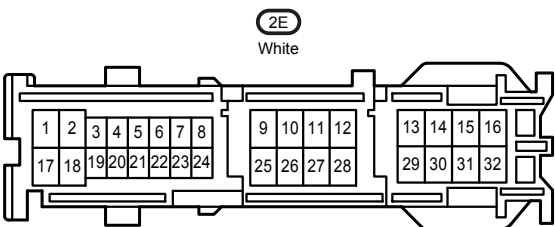
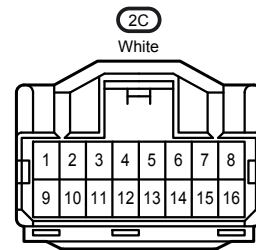
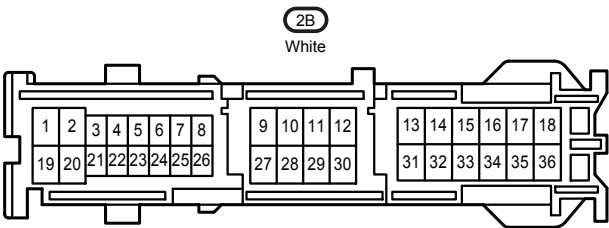
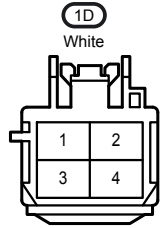
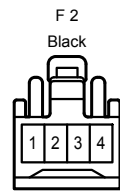
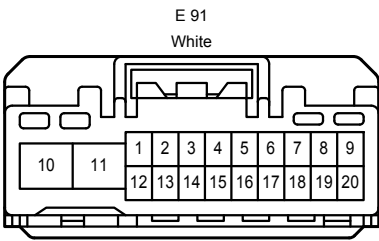
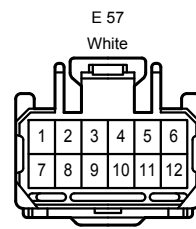
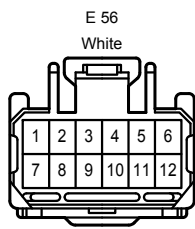
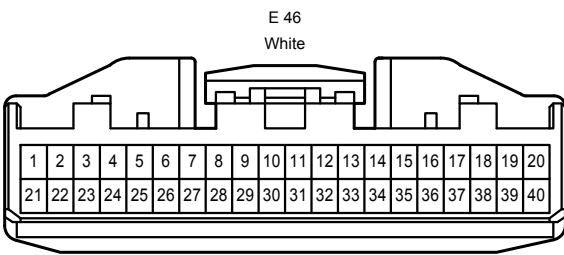
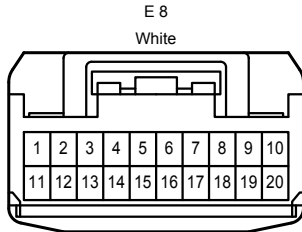
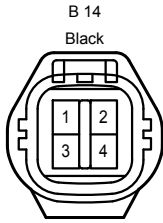
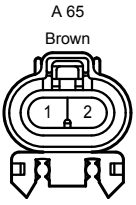
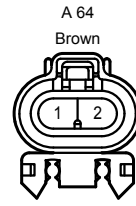
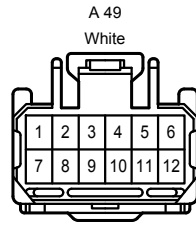
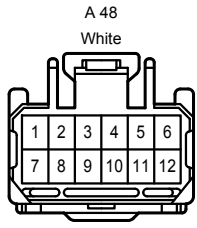
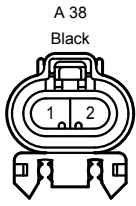
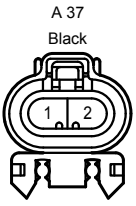

Headlight <TMC Made>

2S

White

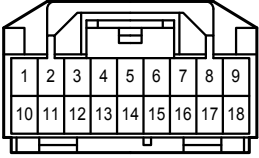

3A

White

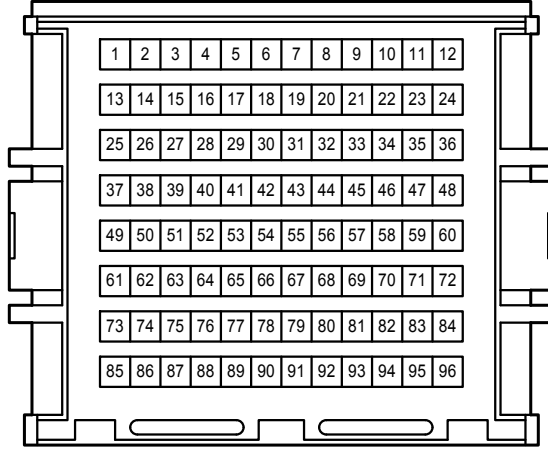

3B

White

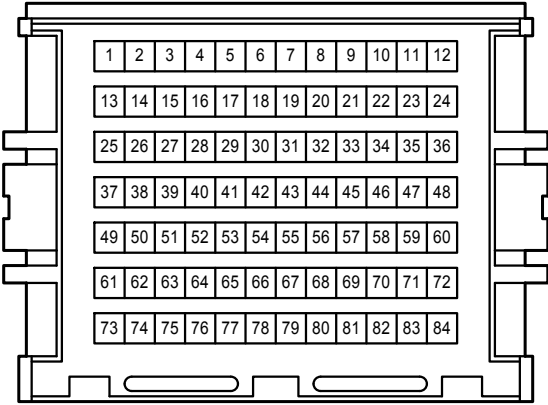

4A

White

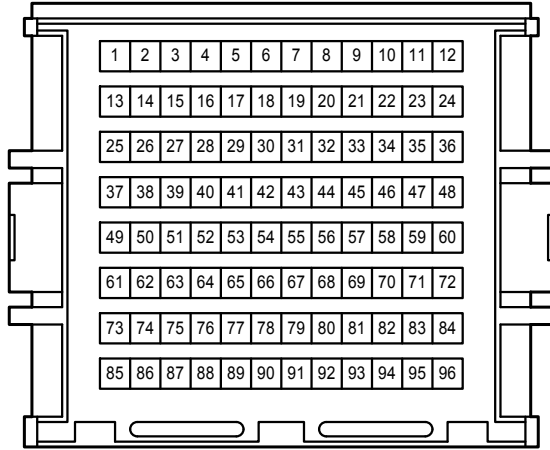

4B

White

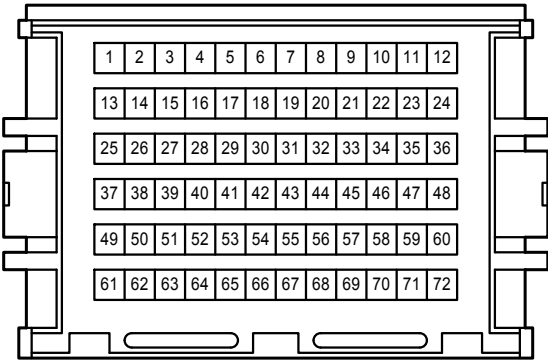

4C

White

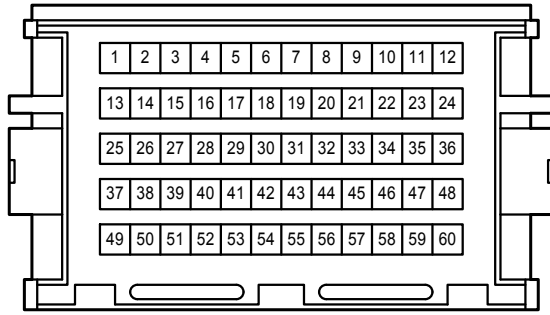

Headlight <TMC Made>

AE9  
White

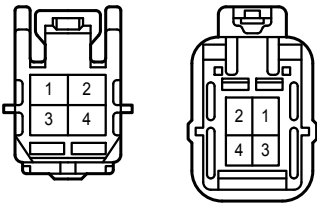

AE11  
White

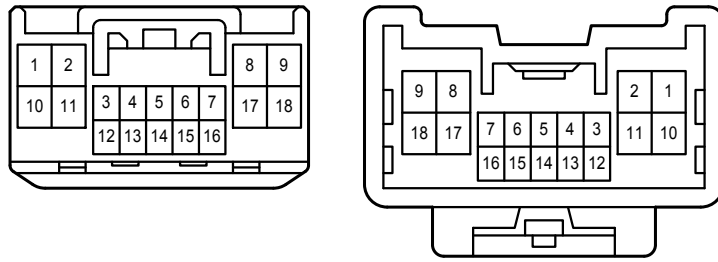

BA1  
White

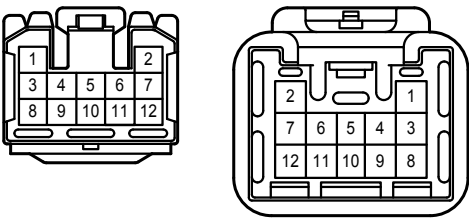

EF1  
White

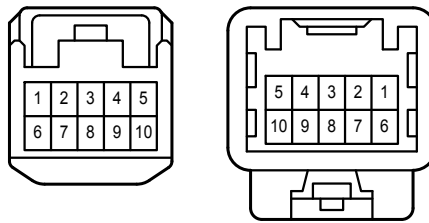

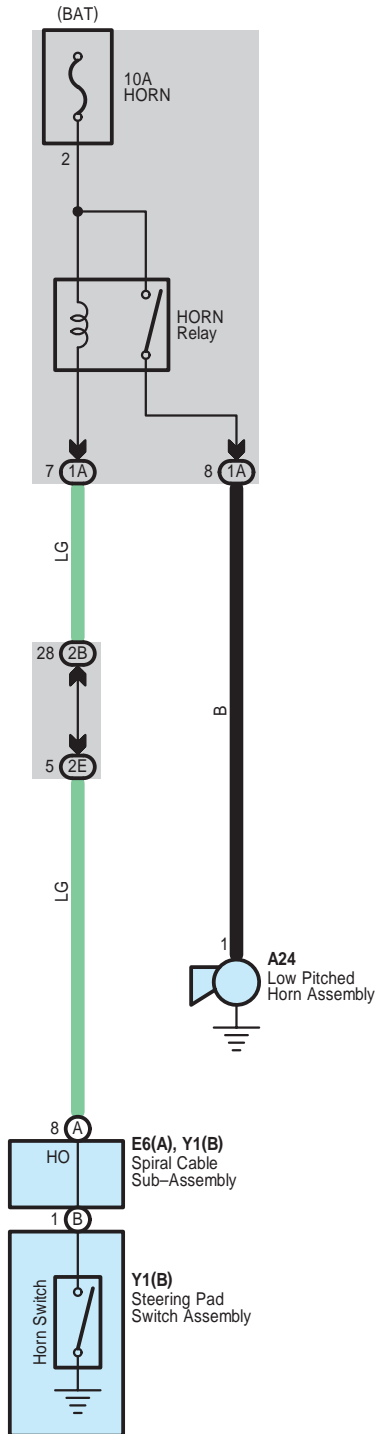

Horn <Except TMC Made>

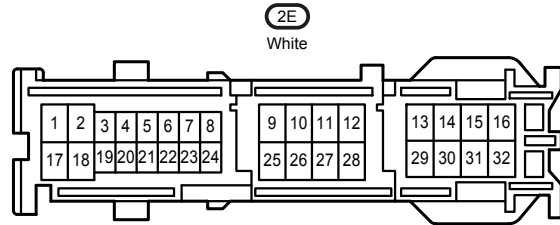
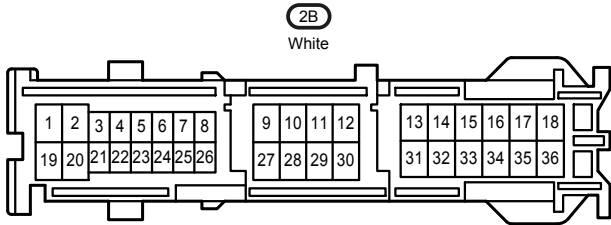
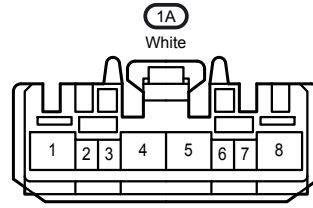
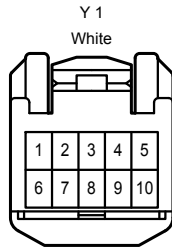
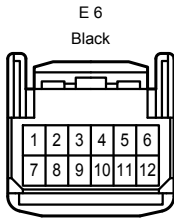
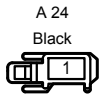

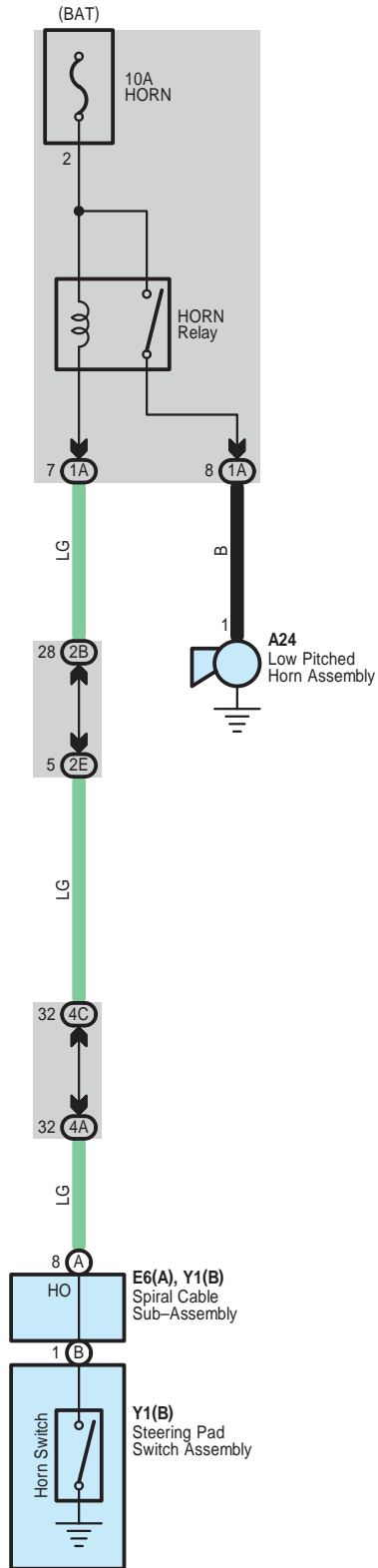



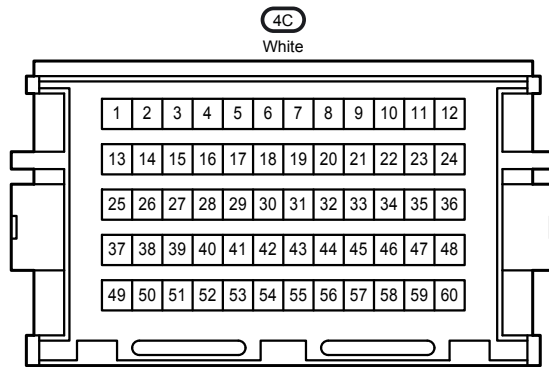
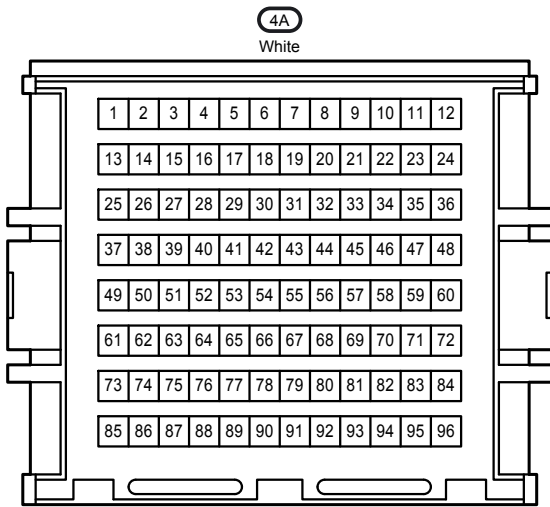
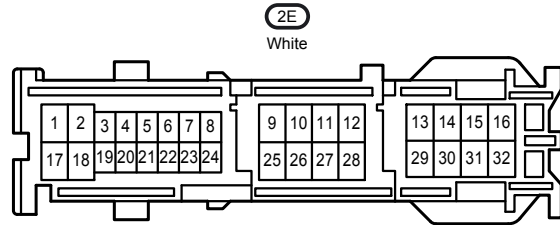
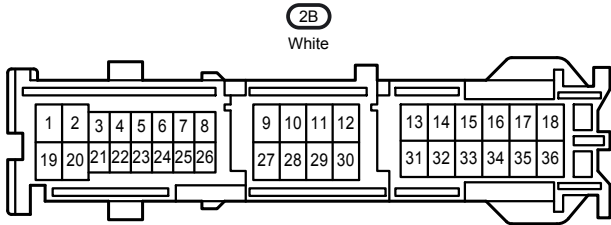
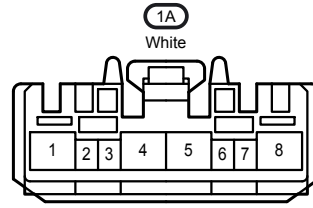
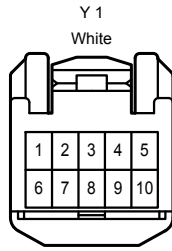
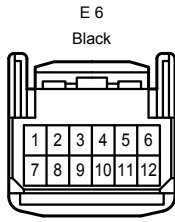
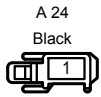

Ignition <Except TMC Made>

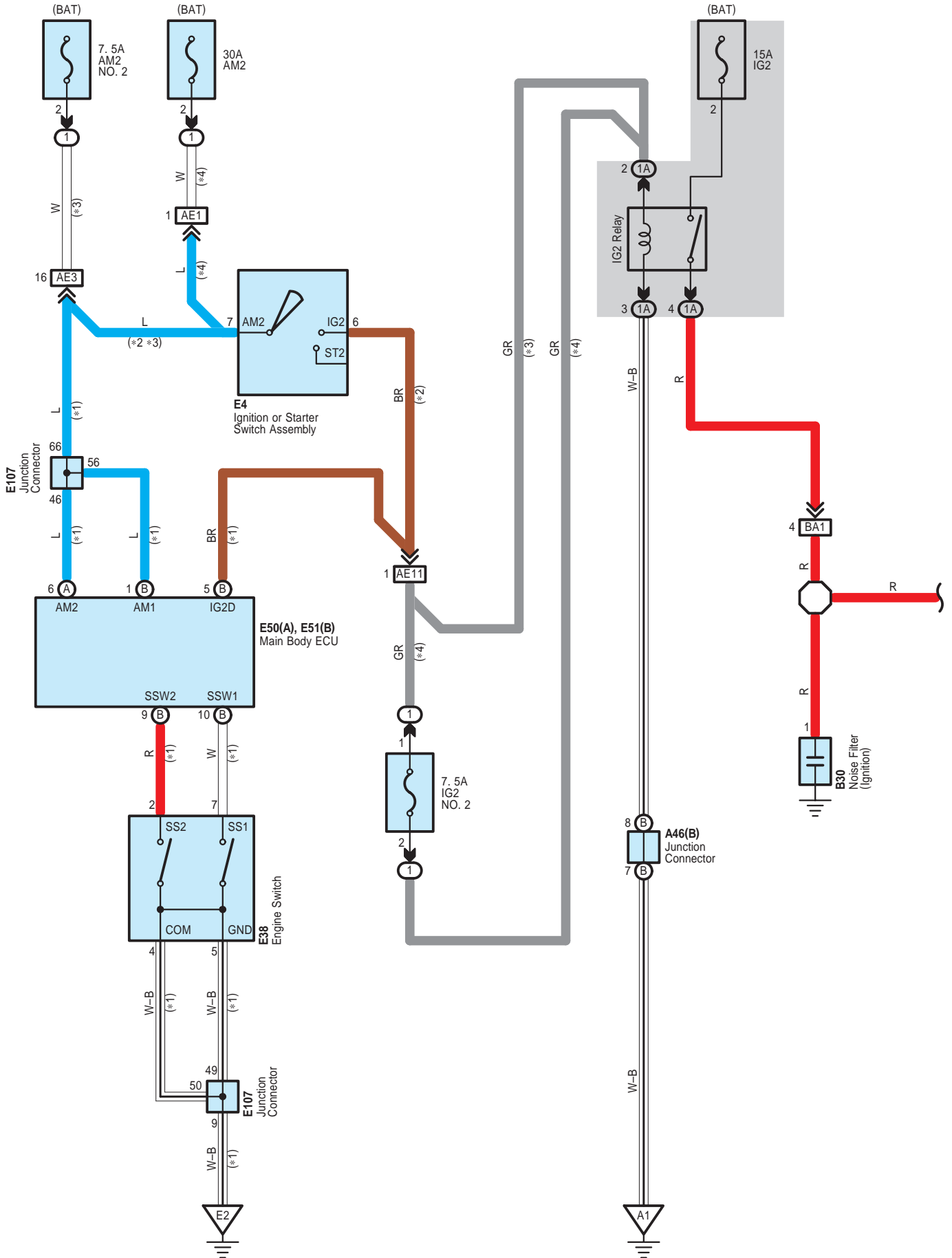

Ignition <Except TMC Made>

- \* 1 : w/ Smart Key System
- \* 2 : w/o Smart Key System
- \* 3 : 2ZR-FE
- \* 4 : 2AZ-FE

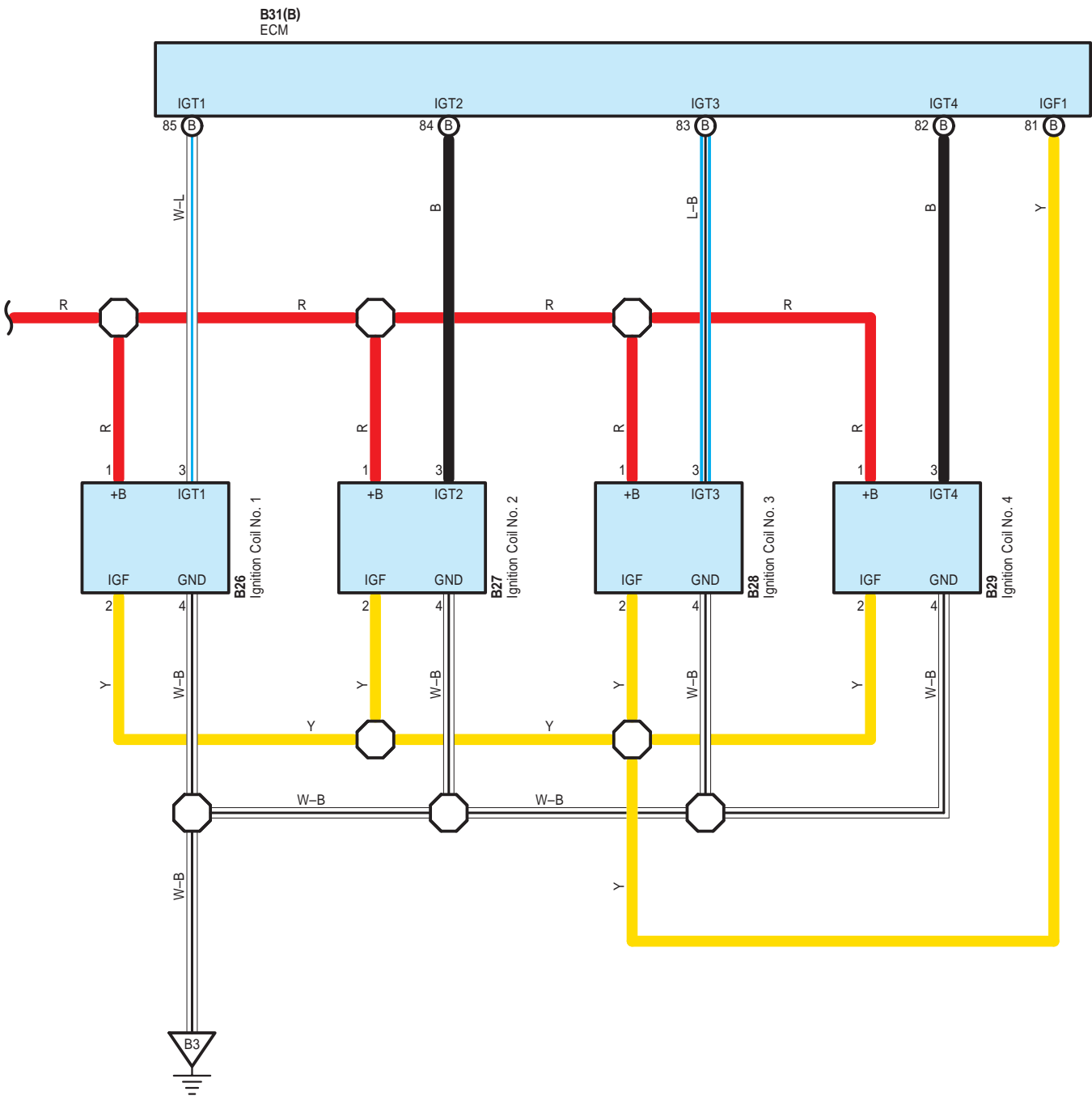



Ignition <Except TMC Made>

E107  
White

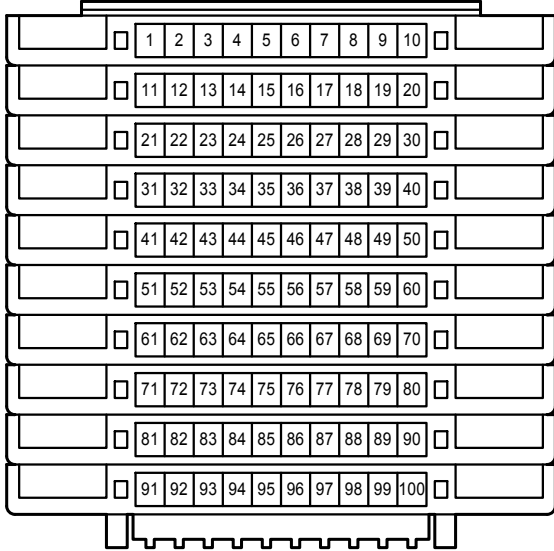

1A  
White

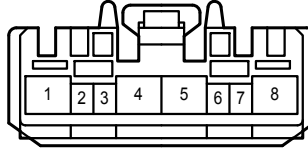

AE1  
White

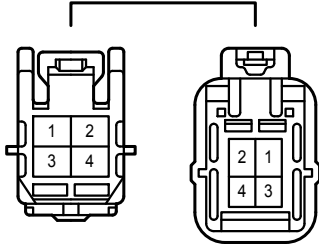

AE3  
White

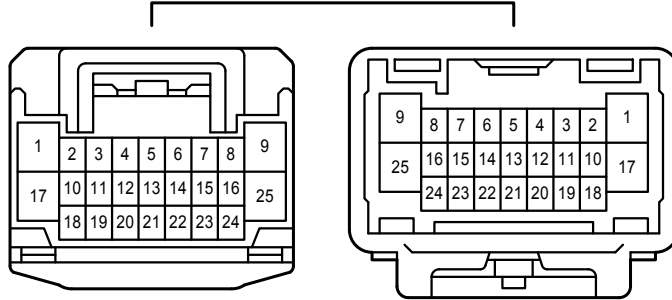

AE11  
White

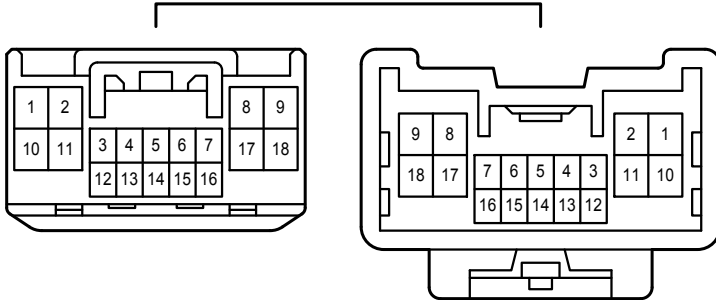

BA1  
White

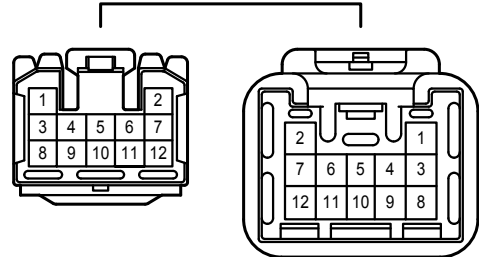

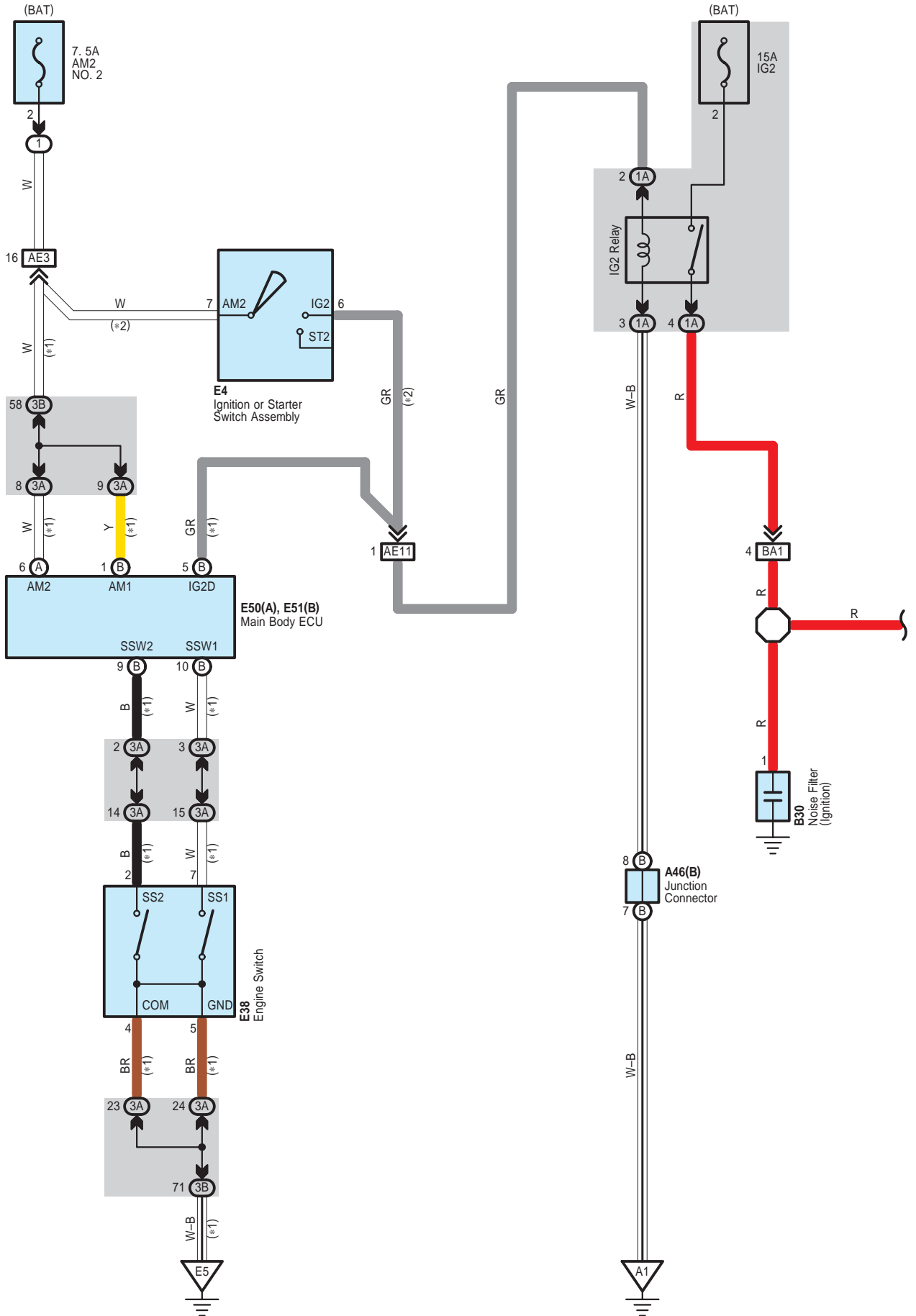

- \* 1 : w/ Smart Key System
- \* 2 : w/o Smart Key System

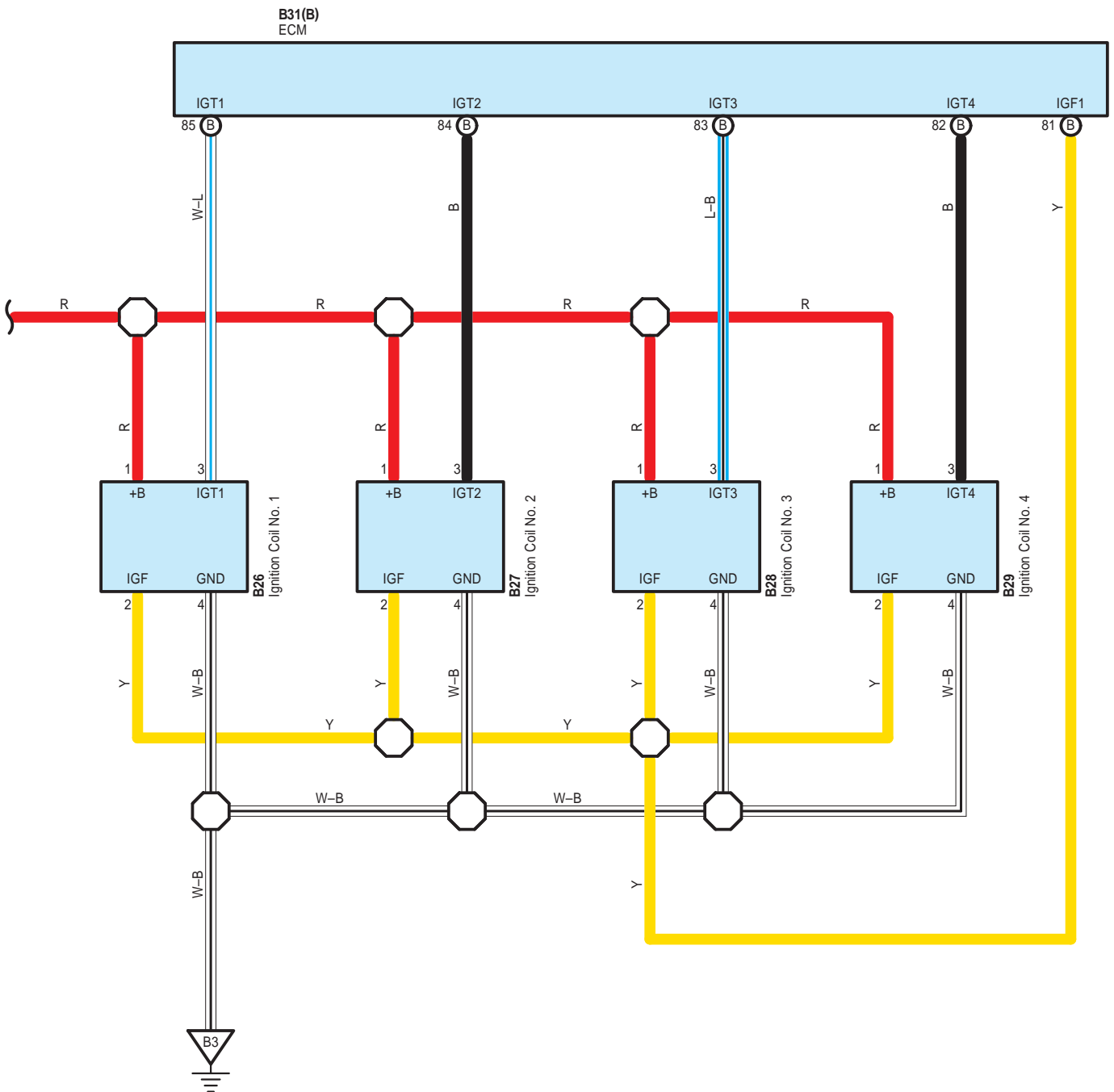





3B  
White

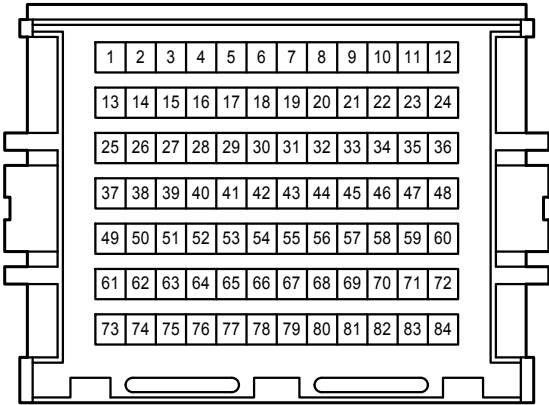

AE3  
White

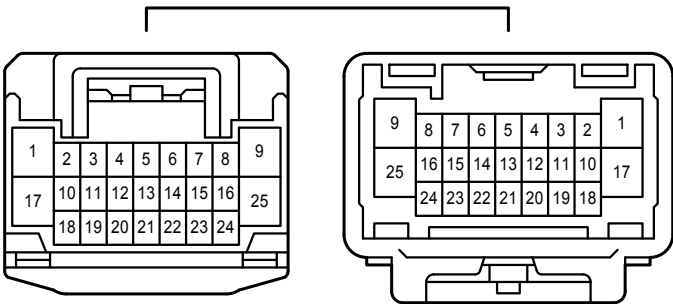

AE11  
White

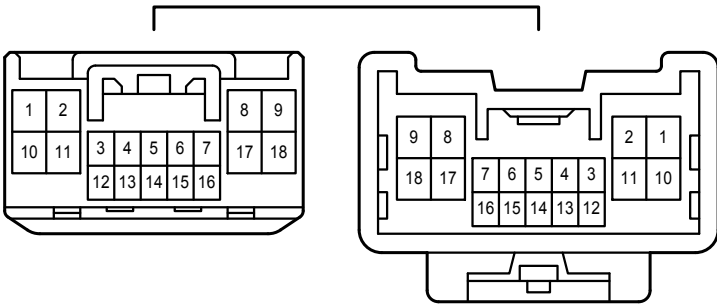

BA1  
White

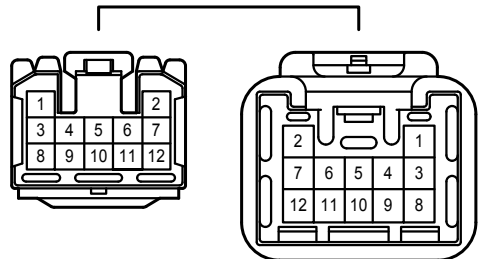

Illumination <Except TMC Made> , Taillight <Except TMC Made>

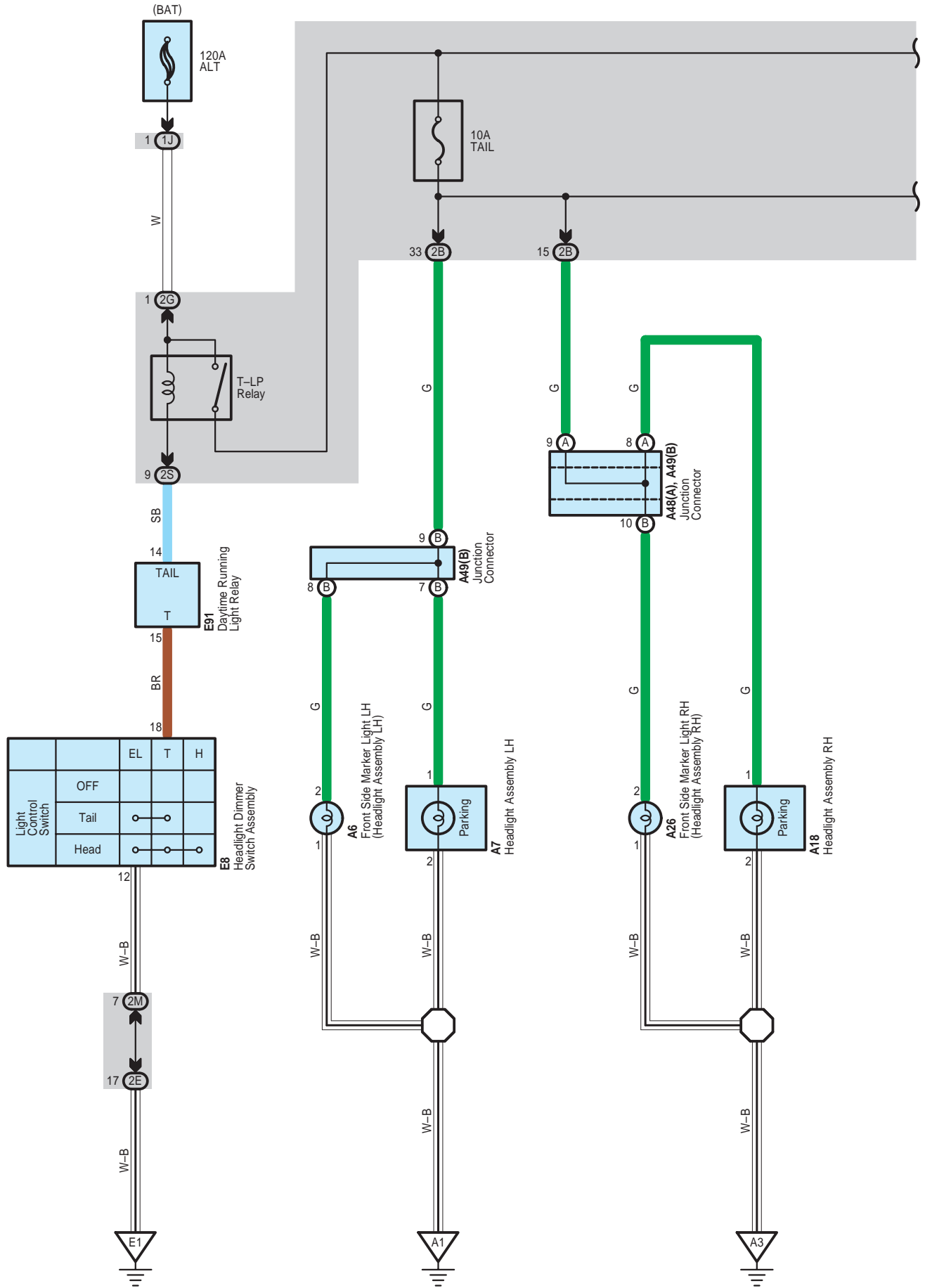

ILLUMINATION <Except TMC Made> , Taillight <Except TMC Made>

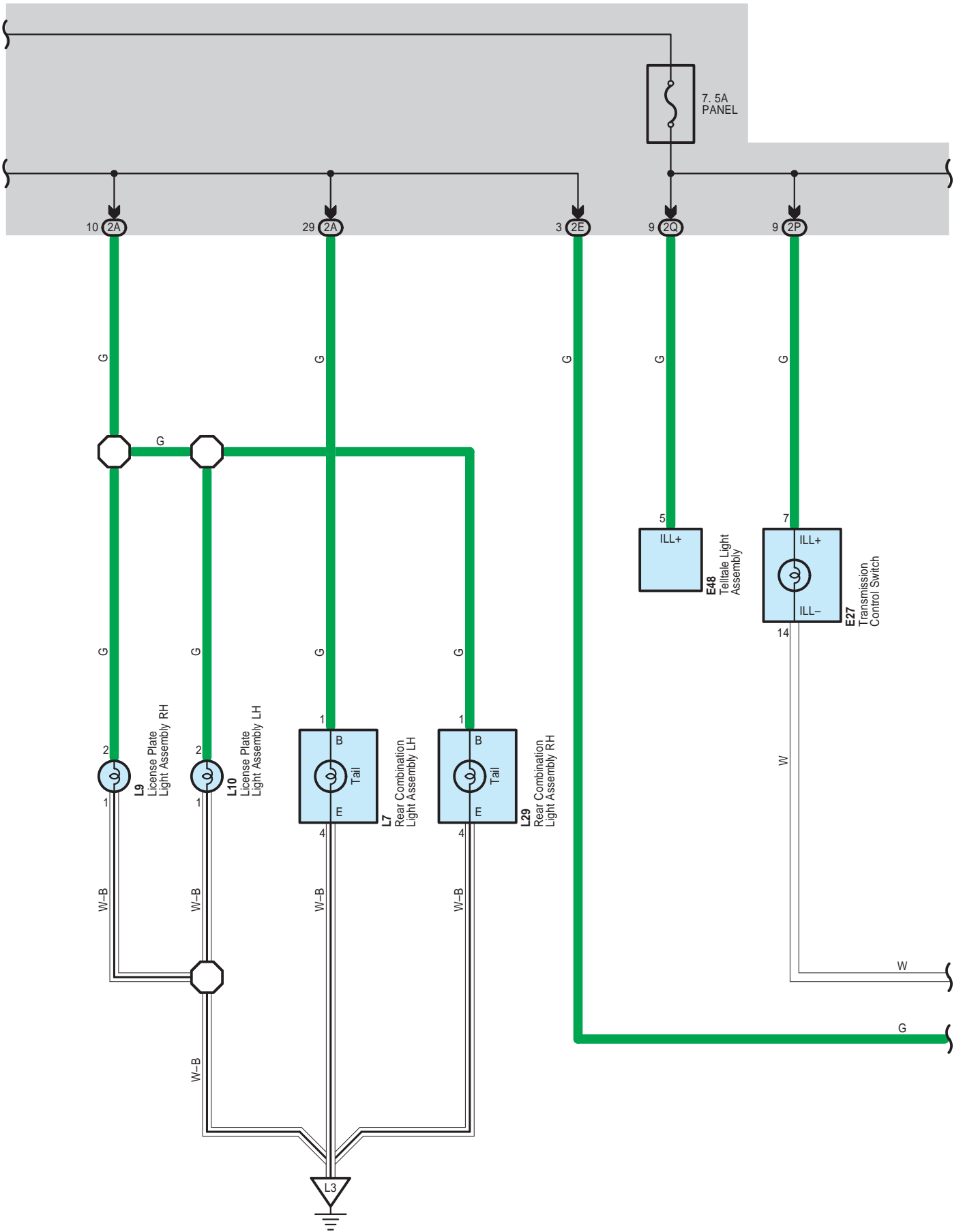

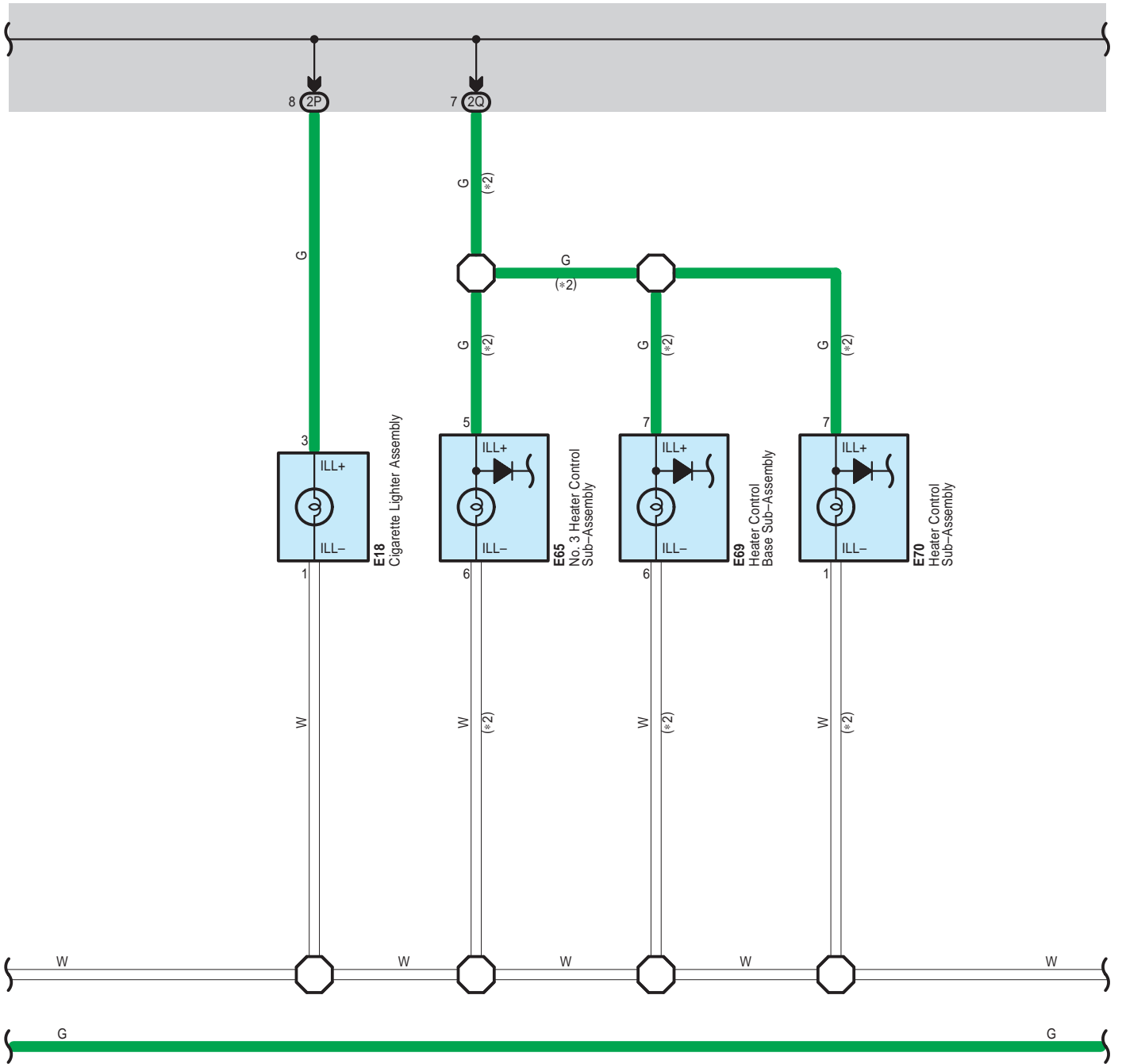

- \* 2 : Manual A/C
- \* 3 : w/ Steering Pad Switch
- \* 4 : Separate Type Amplifier
- \* 5 : Built-In Type Amplifier

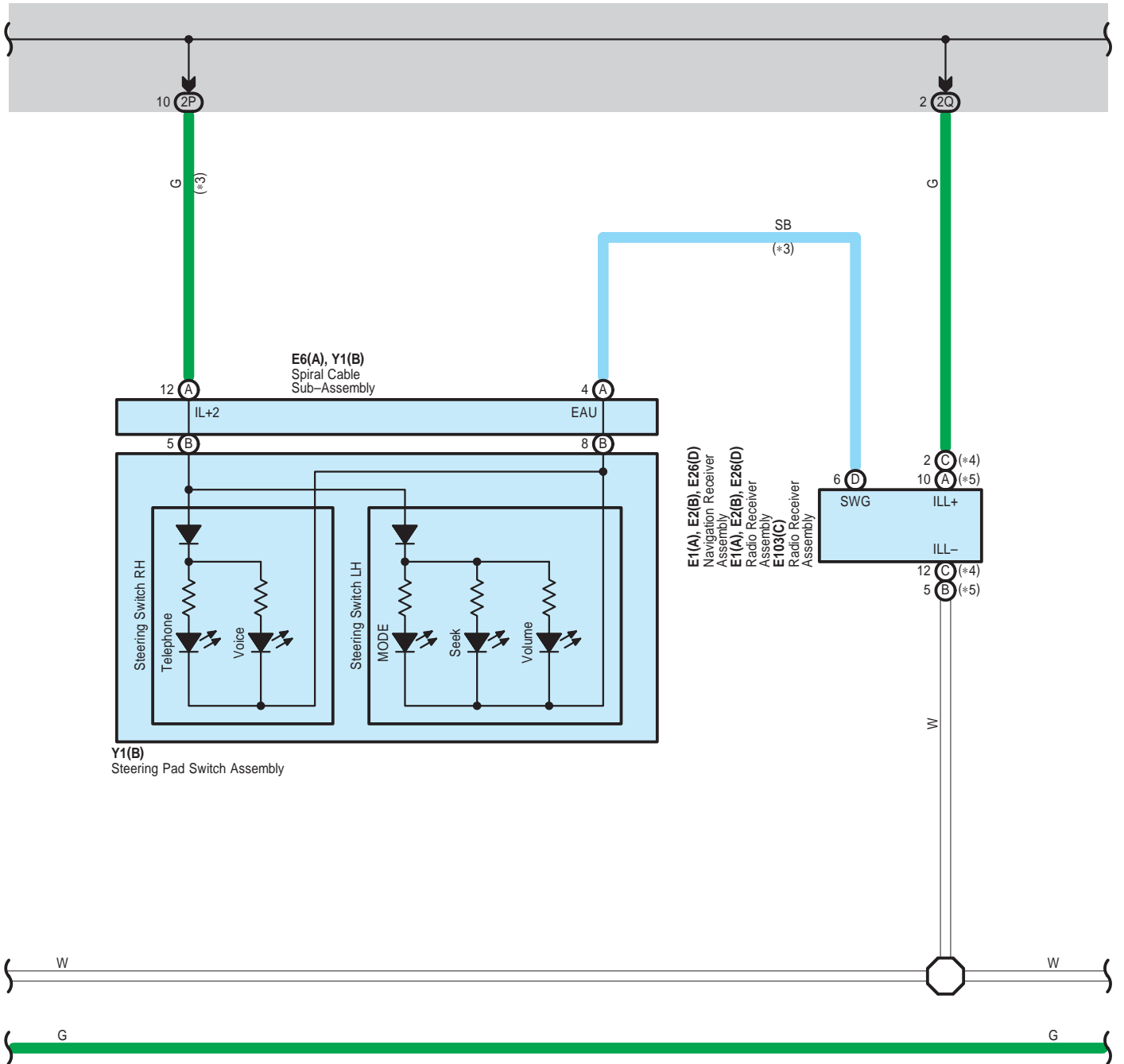

Illumination <Except TMC Made> , Taillight <Except TMC Made>

- \* 1 : Automatic A/C
- \* 6 : w/ Smart Key System
- \* 7 : Optitron Meter
- \* 8 : Except Optitron Meter
- \* 9 : Optitron Meter Except USA

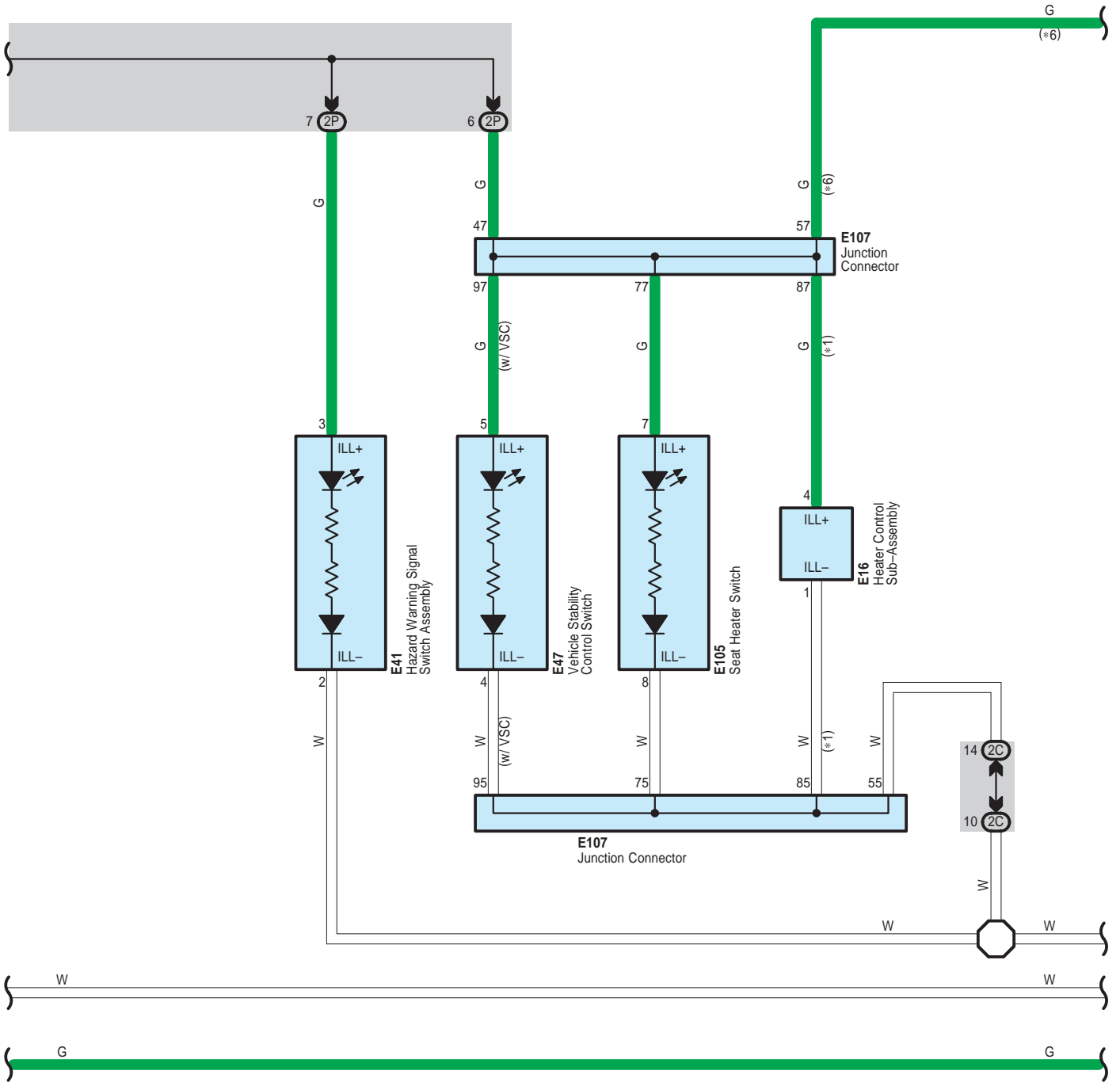

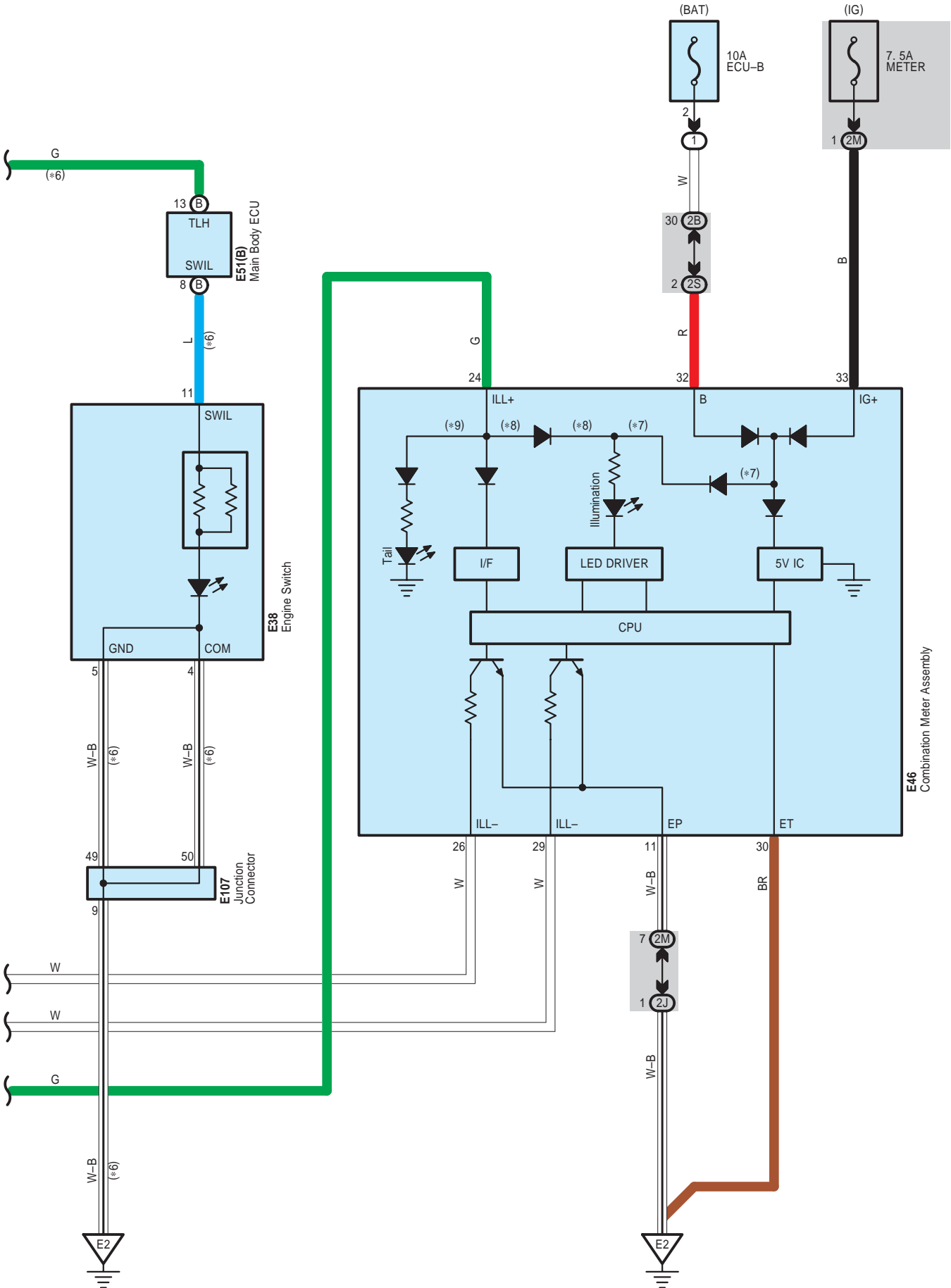

Illumination <Except TMC Made> , Taillight <Except TMC Made>

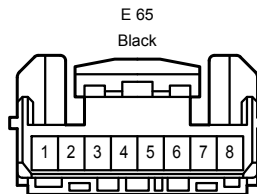
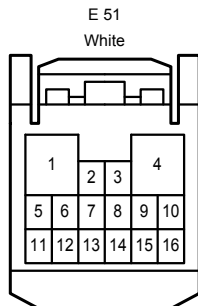
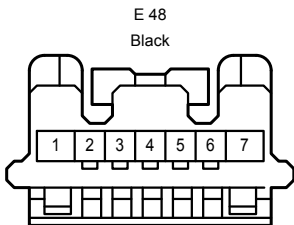
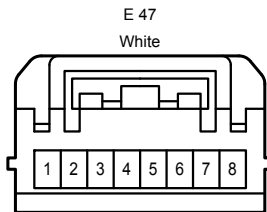
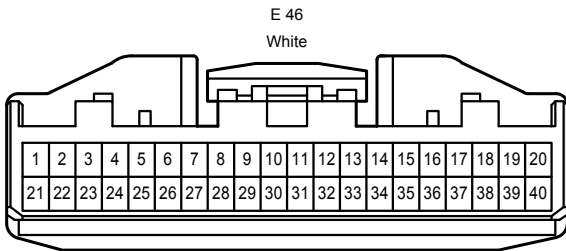
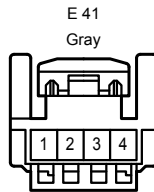
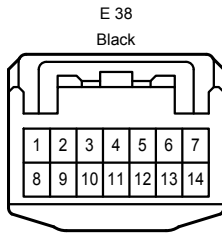
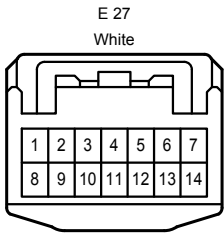
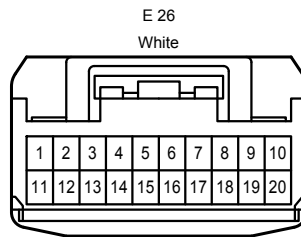
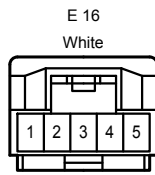
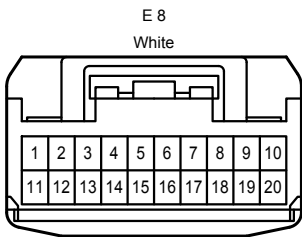
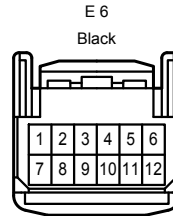
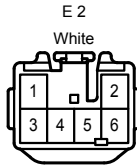
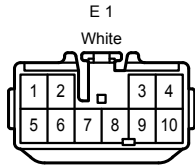
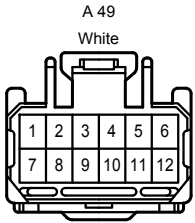
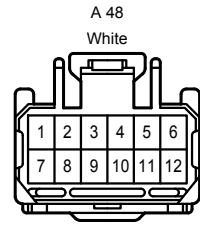
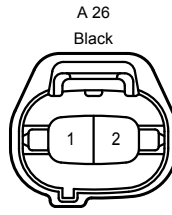
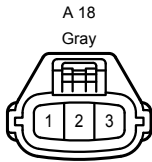
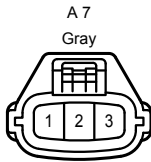
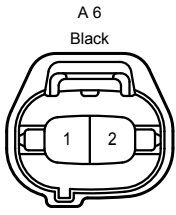



Illumination <Except TMC Made> , Taillight <Except TMC Made>

E 69  
Gray

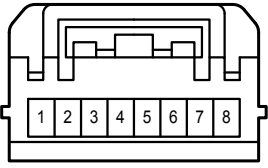

E 70  
Gray

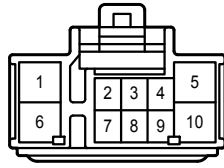

E 91  
White

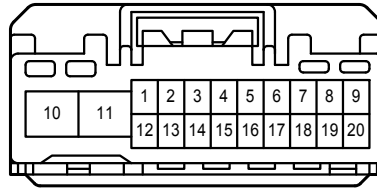

E103  
White

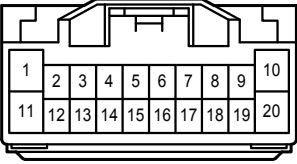

E105  
Black

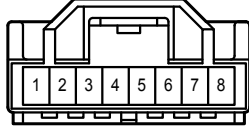

E107  
White

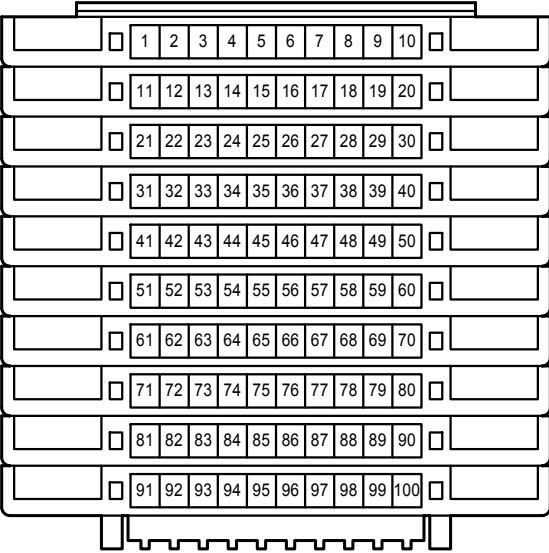

L 7  
White

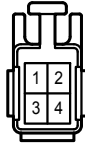

L 9  
Black



L 10  
Black



L 29  
White

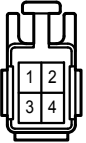

Y 1  
White

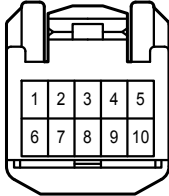

1J



2A  
White

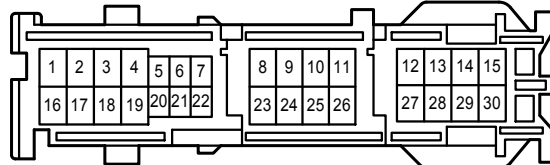

2B  
White

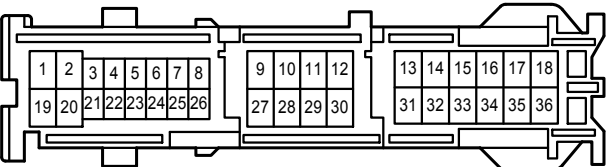

2C  
White

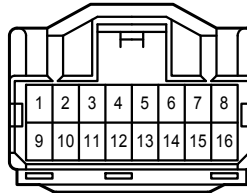

2E  
White

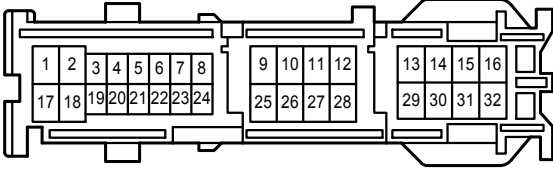

2G  
White

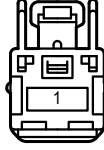

2J  
White

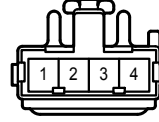

2M  
White

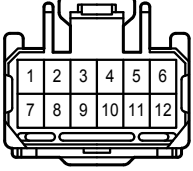

2P  
White

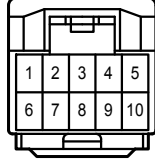

2Q  
White

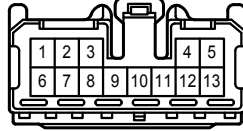

2S  
White

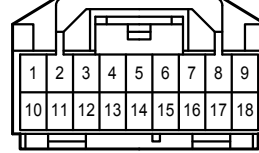

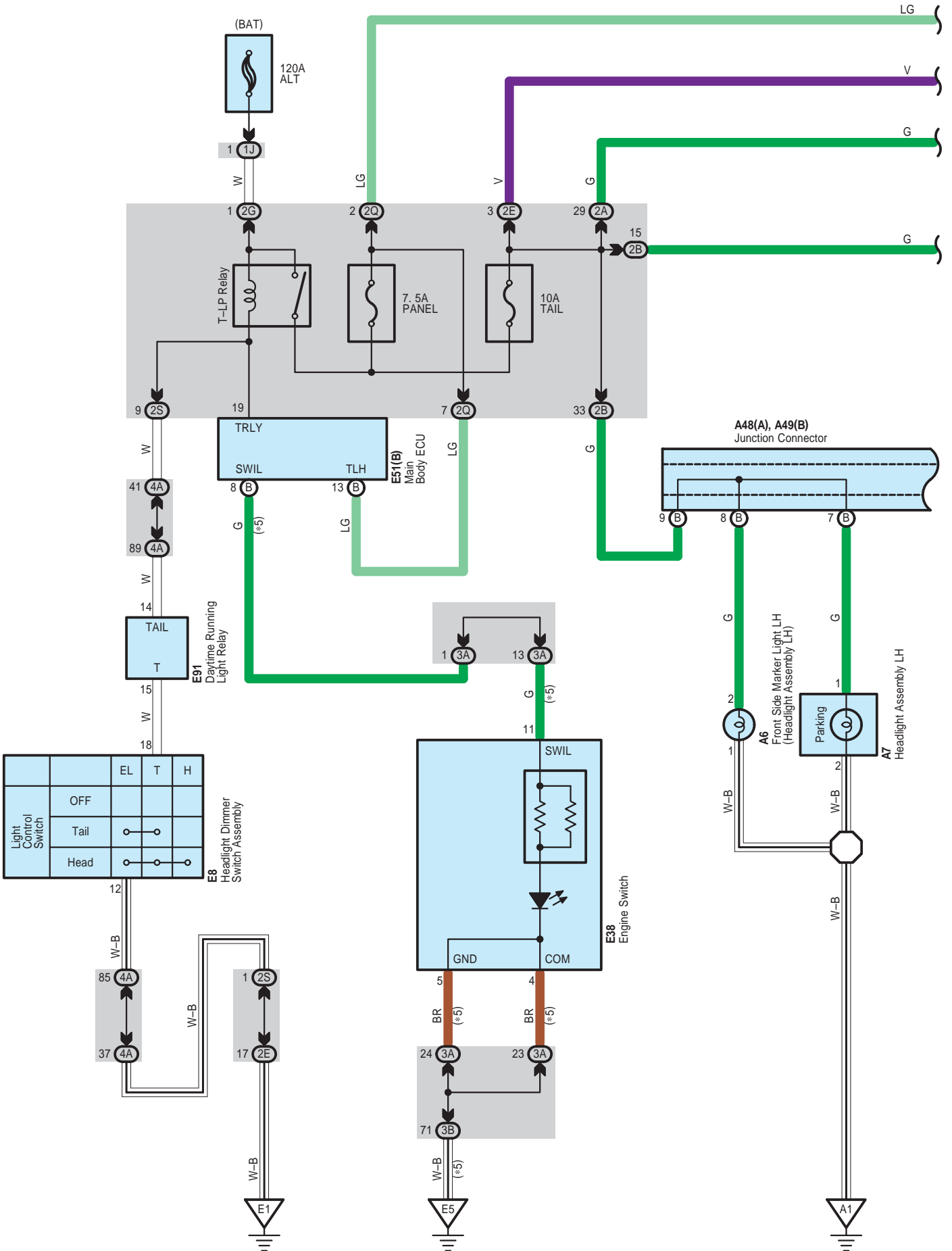

Illumination <TMC Made> , Taillight <TMC Made>

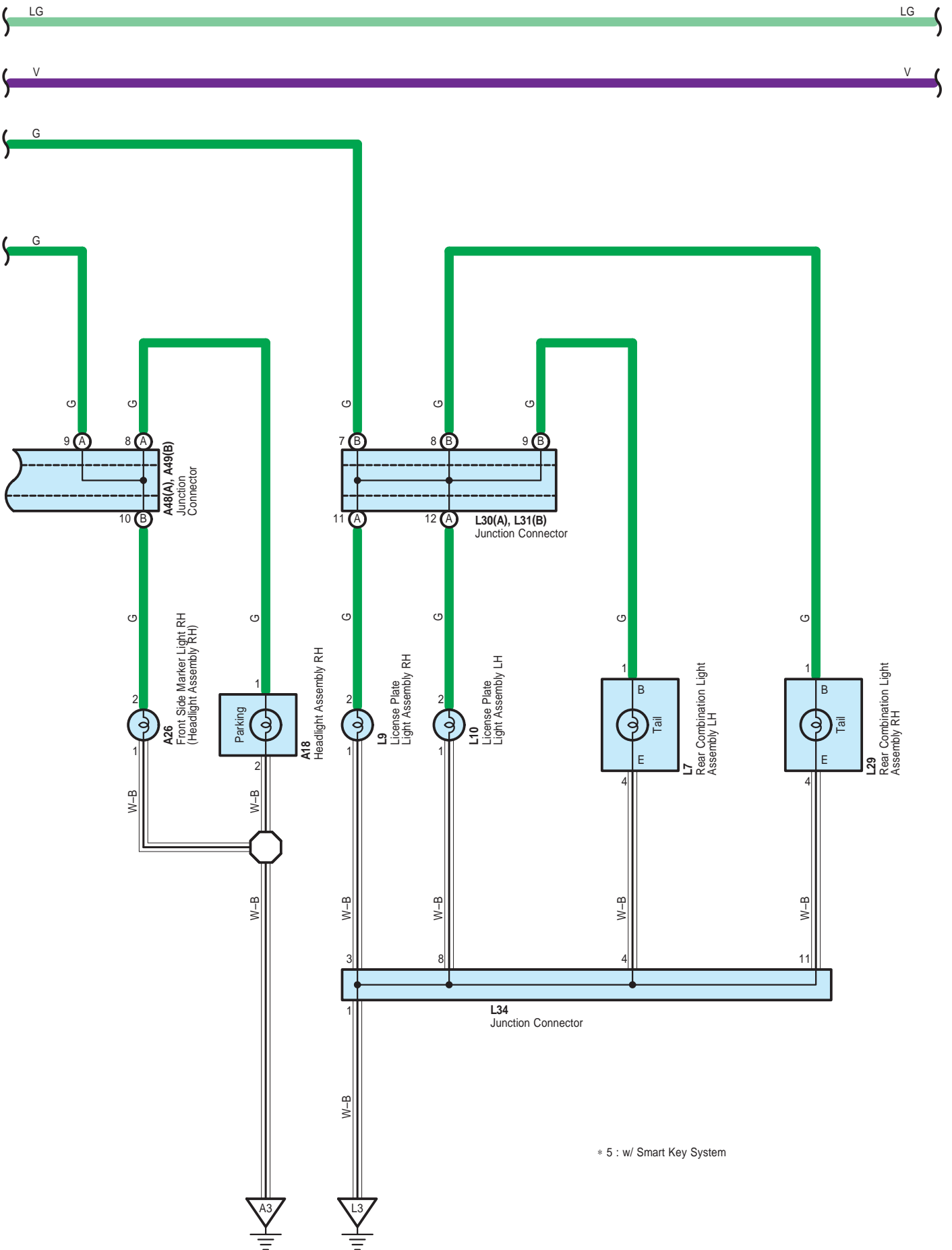

\* 5 : w/ Smart Key System

Illumination <TMC Made> , Taillight <TMC Made>

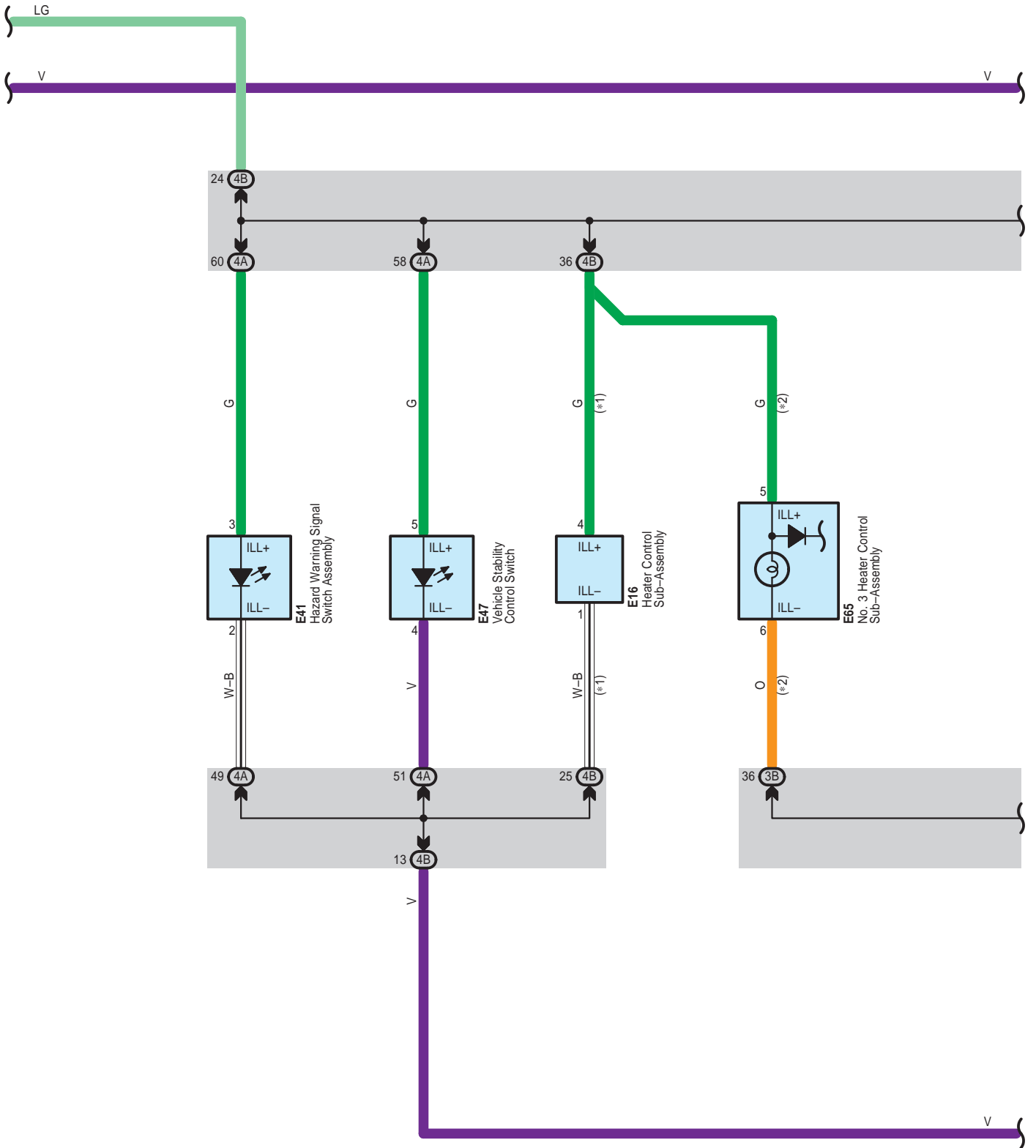

illumination <TMC Made> , Taillight <TMC Made>

- \* 1 : Automatic A/C
- \* 2 : Manual A/C

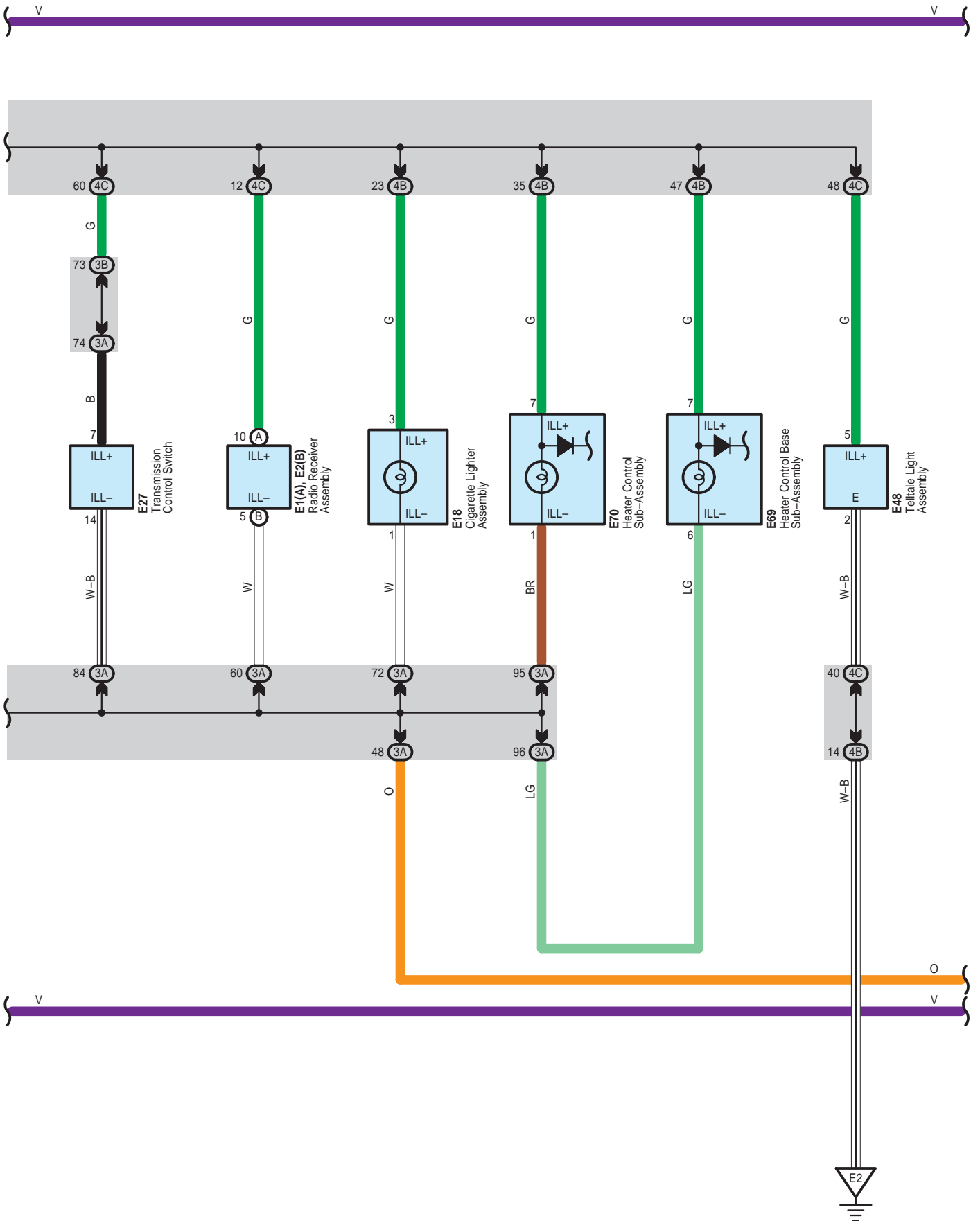

illumination <TMC Made> , Taillight <TMC Made>

- \* 3 : Optitron Meter
- \* 4 : Except Optitron Meter

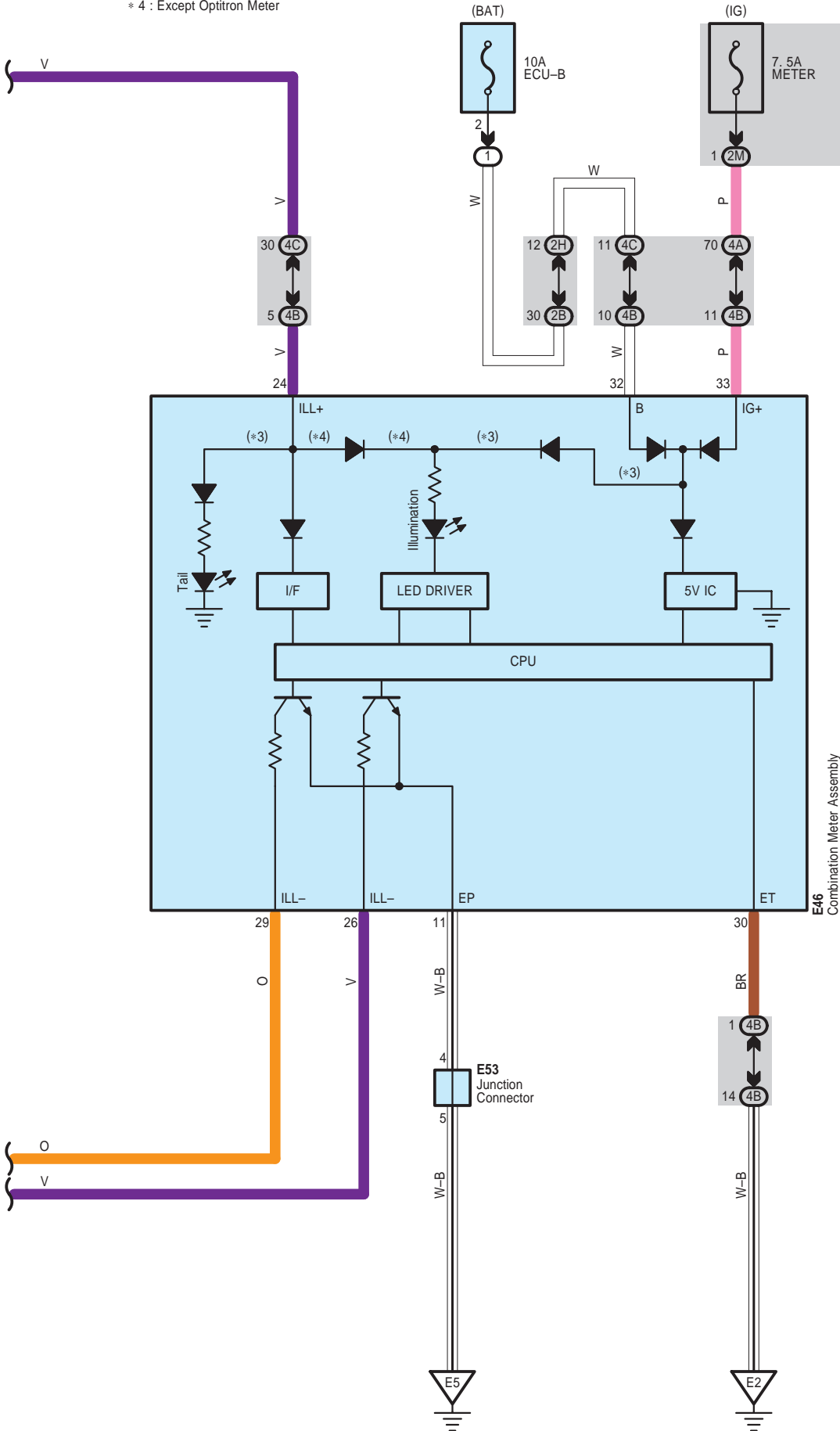

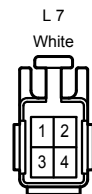
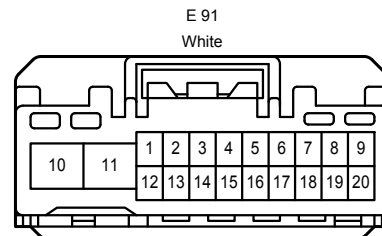
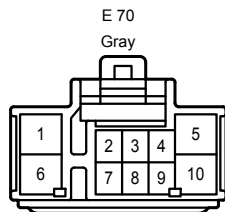
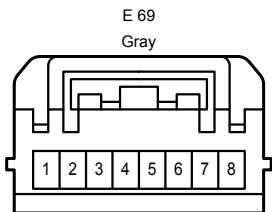
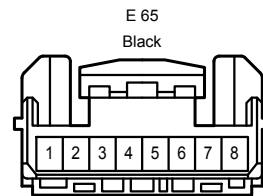
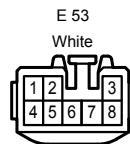
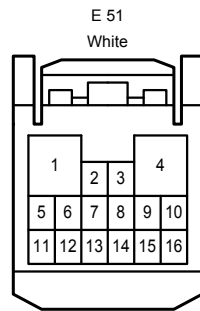
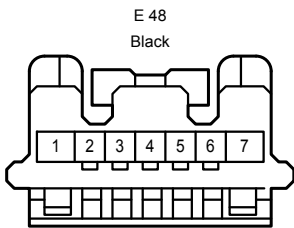
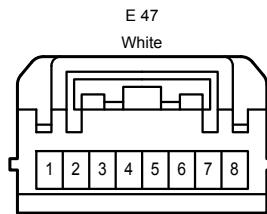
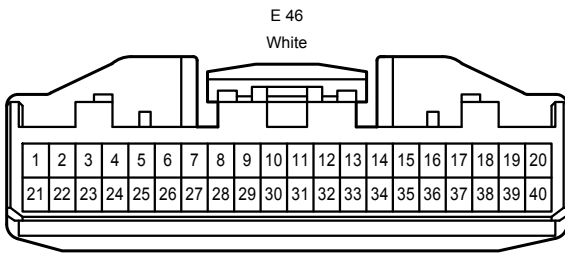
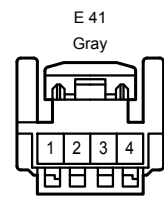
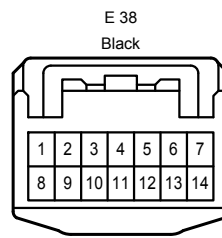
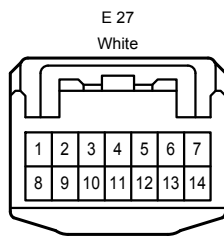
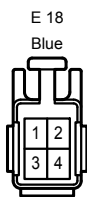
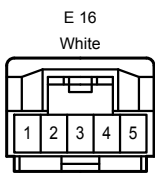
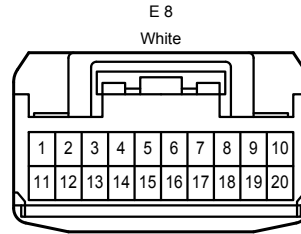
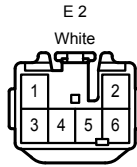
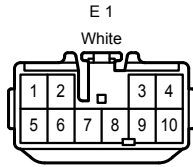
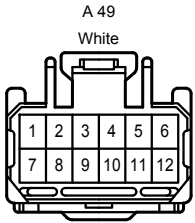
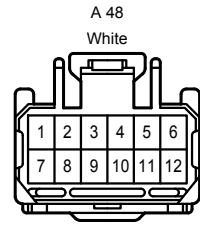
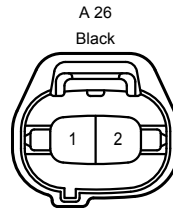
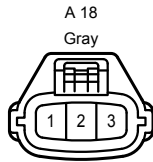
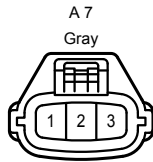
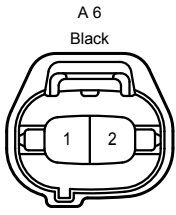



Illumination <TMC Made> , Taillight <TMC Made>

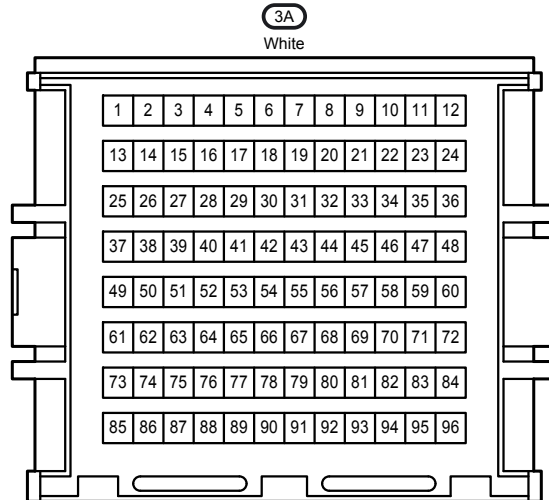
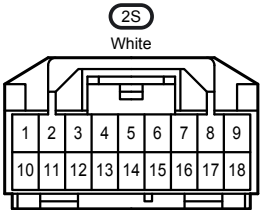
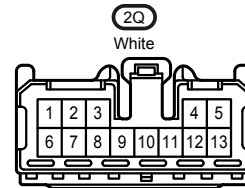
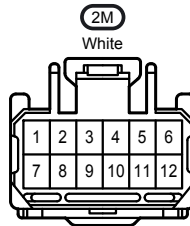
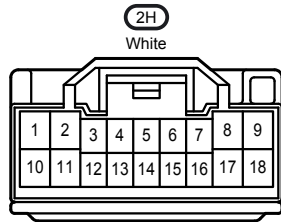
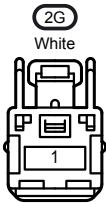
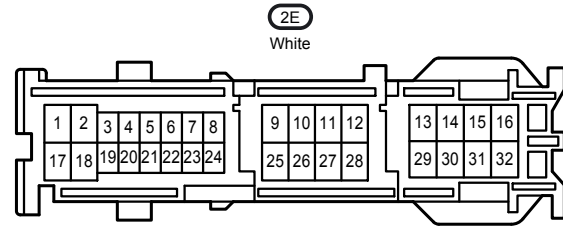
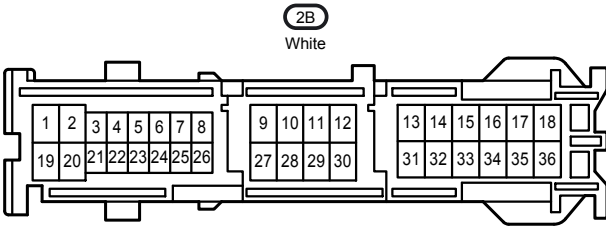
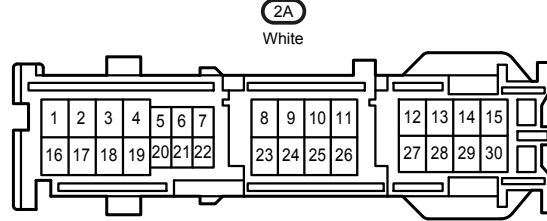
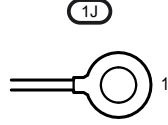
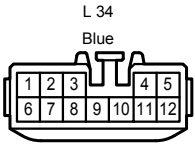
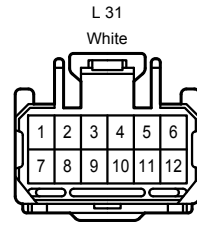
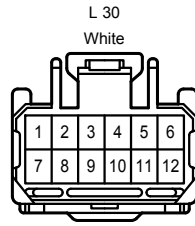
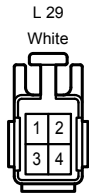
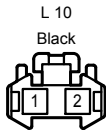
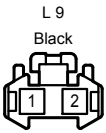

3B  
White

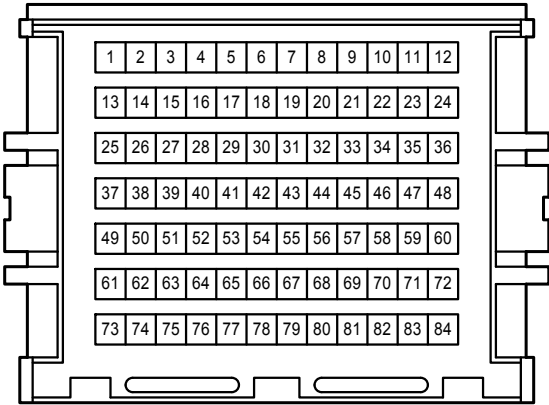

4A  
White

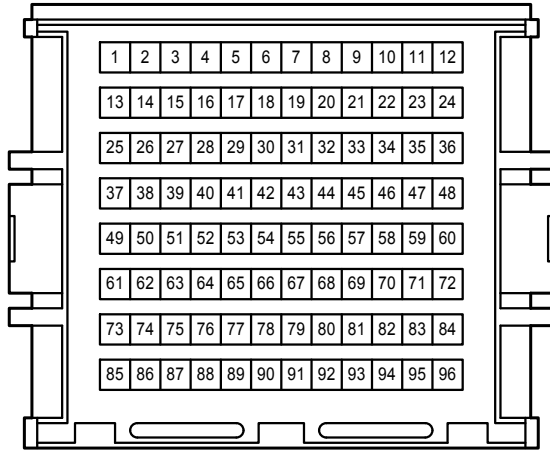

4B  
White

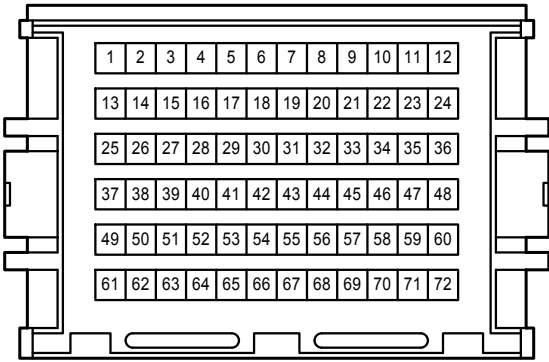

4C  
White

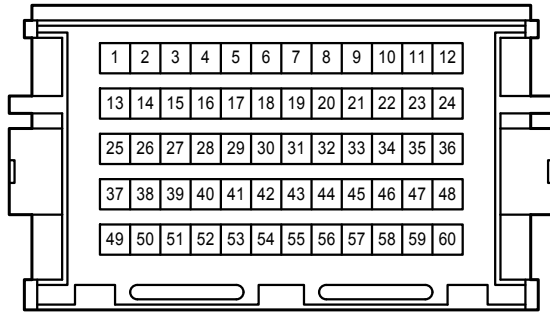

Interior Light <TMC Made>

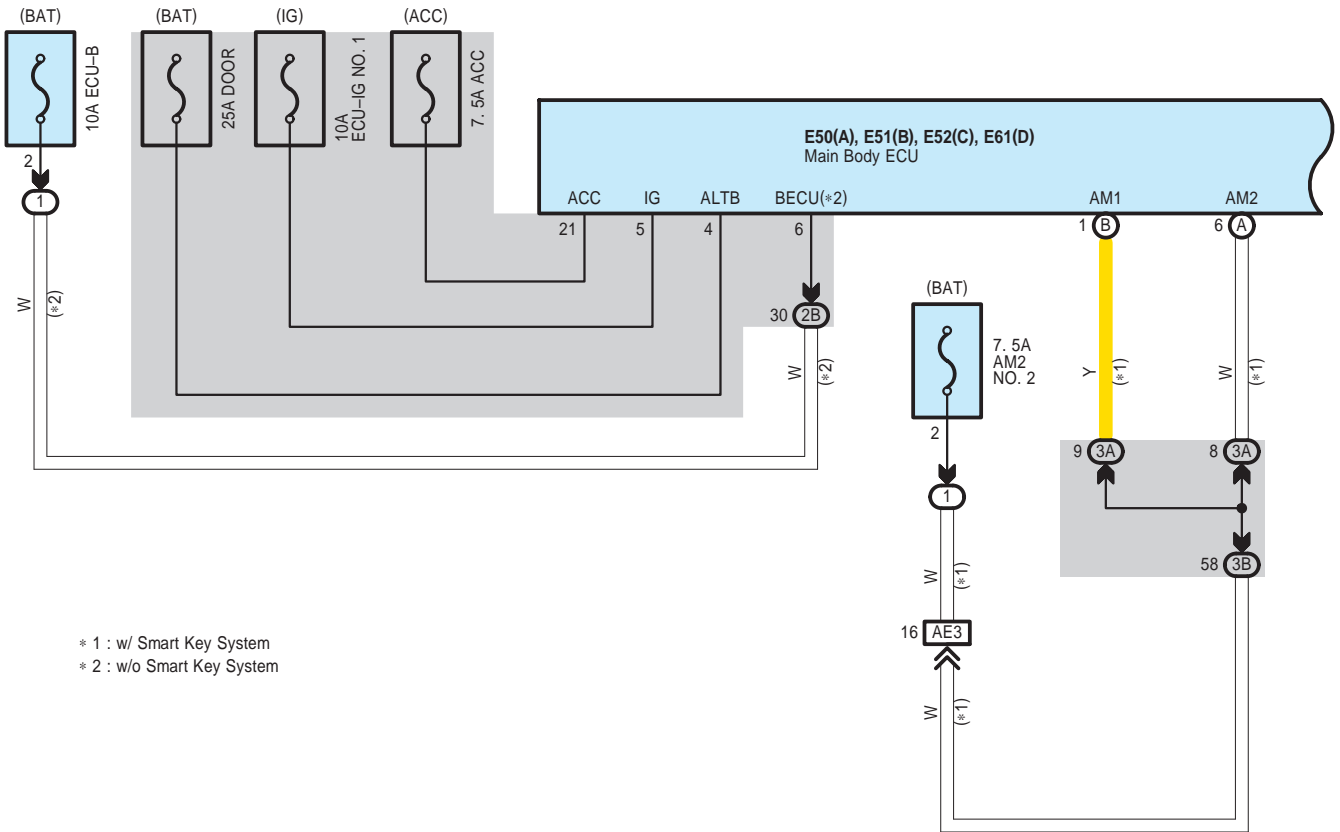

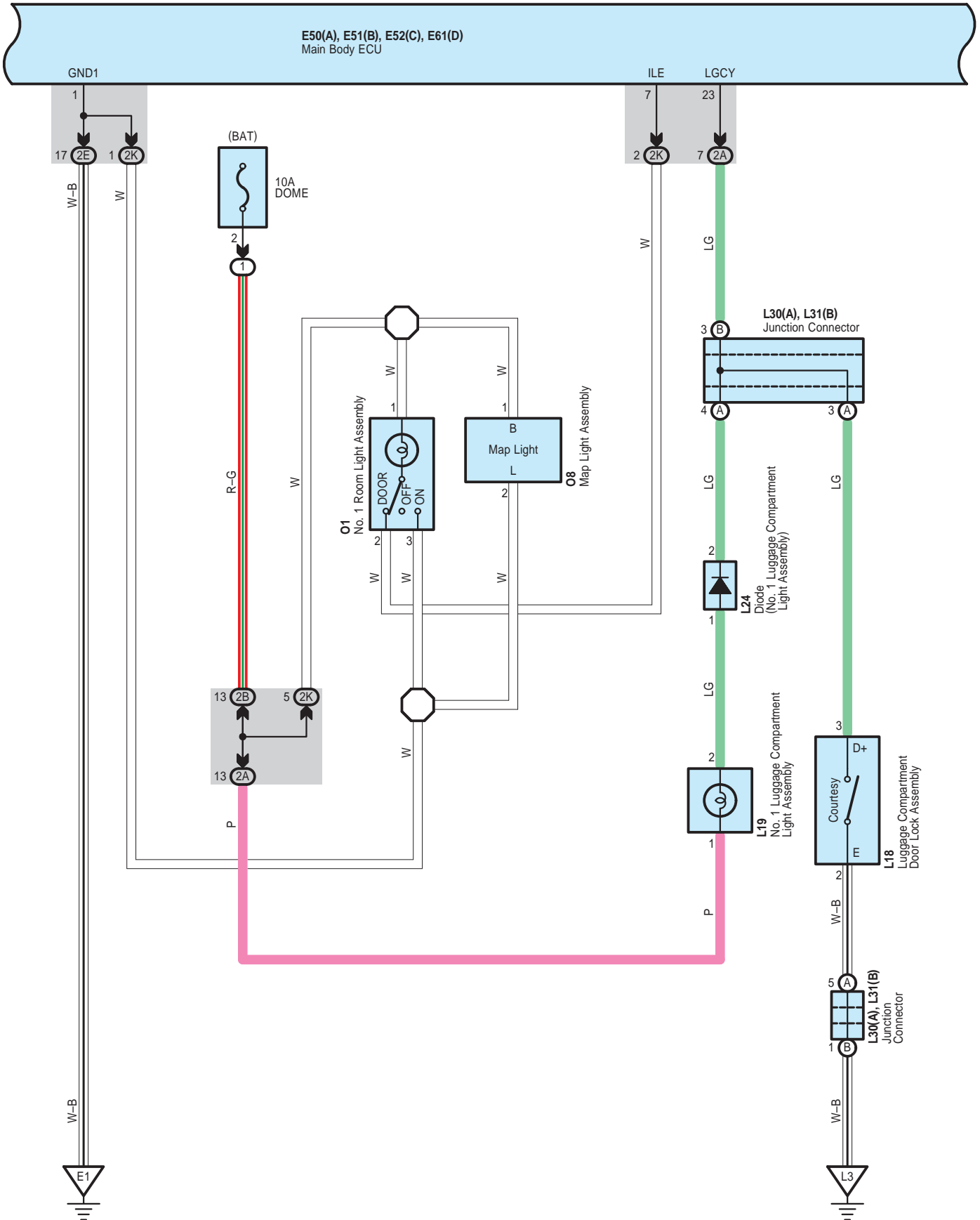

Interior Light <TMC Made>

\* 1 : w/ Smart Key System  
 \* 2 : w/o Smart Key System

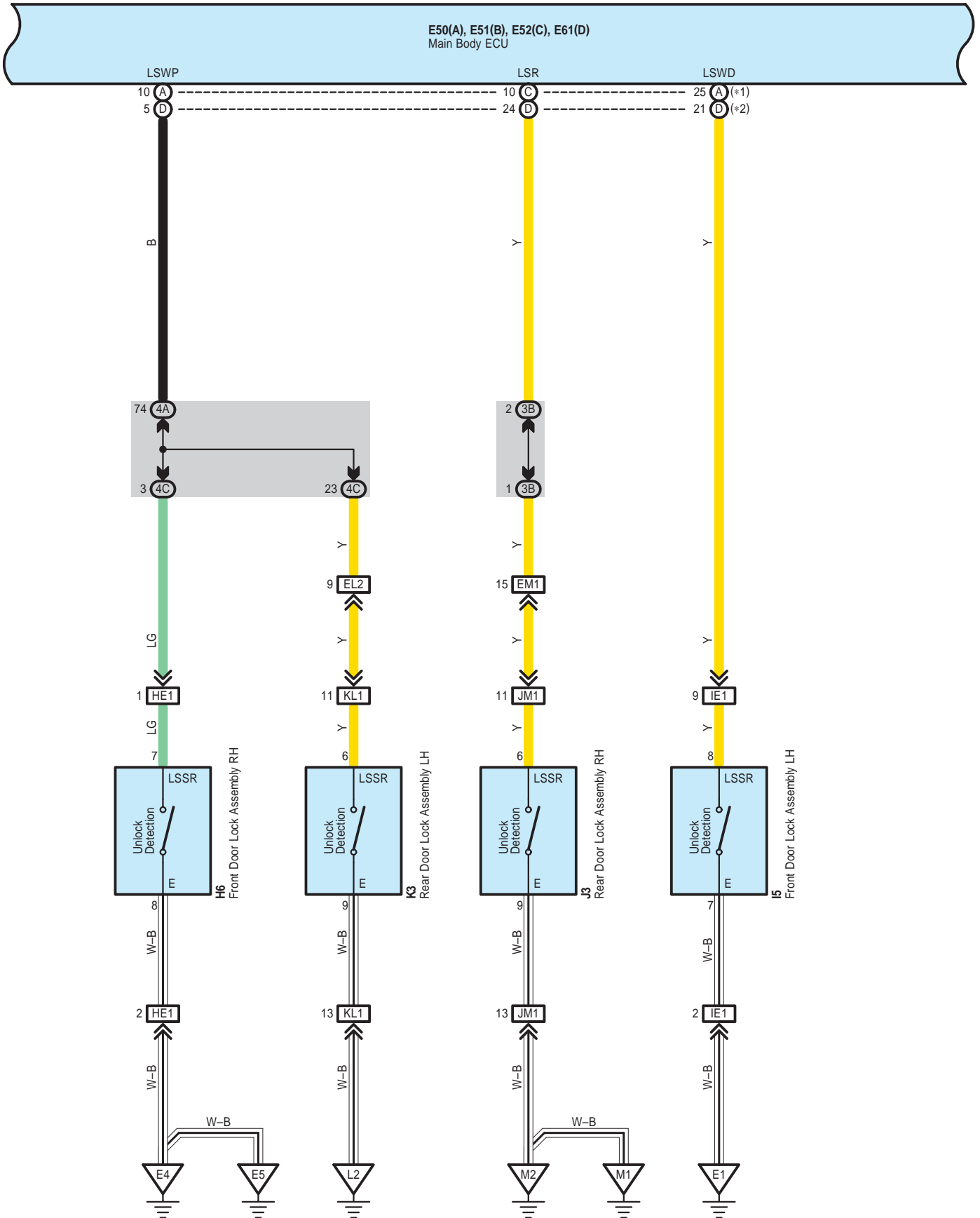

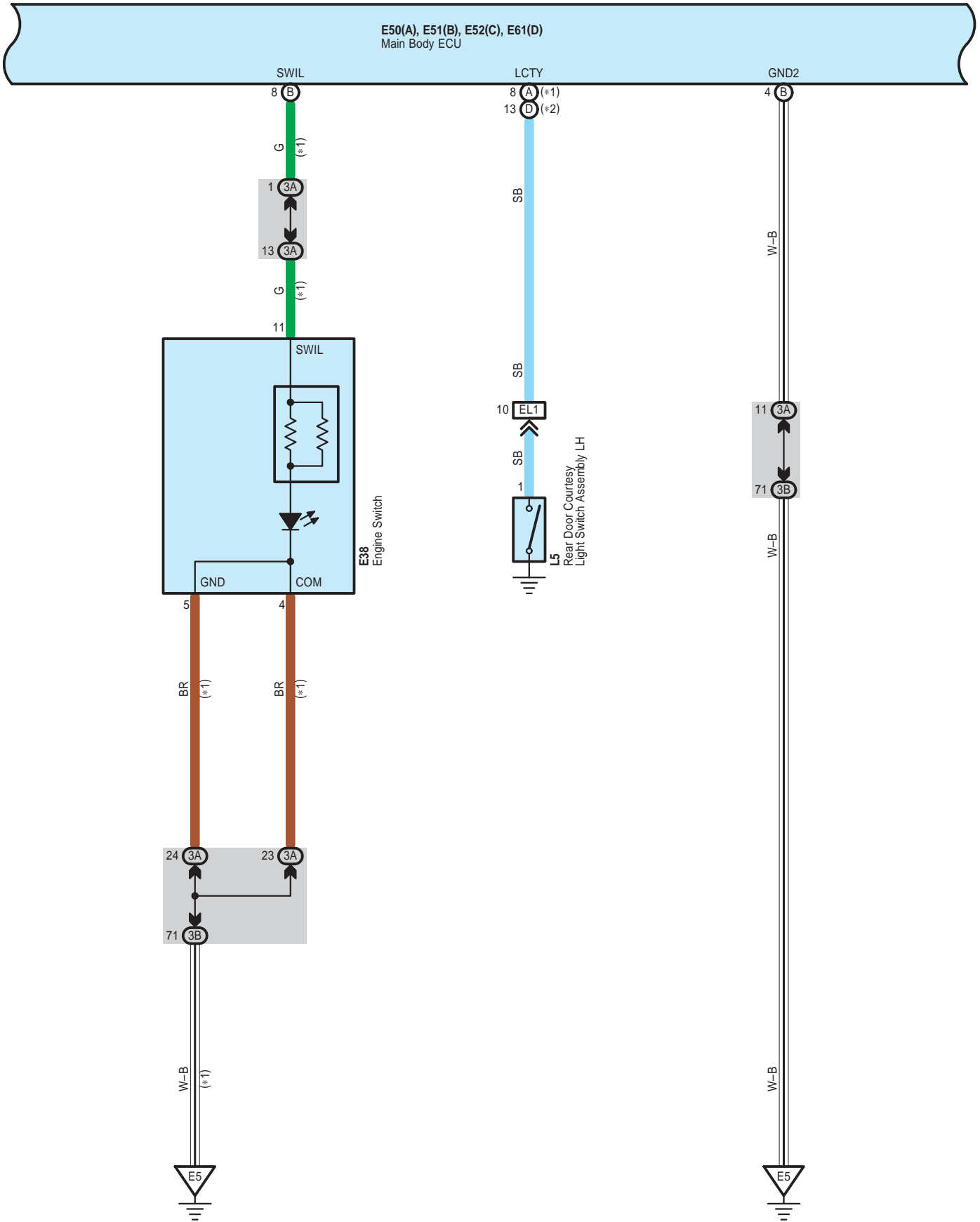

\* 2 : w/o Smart Key System

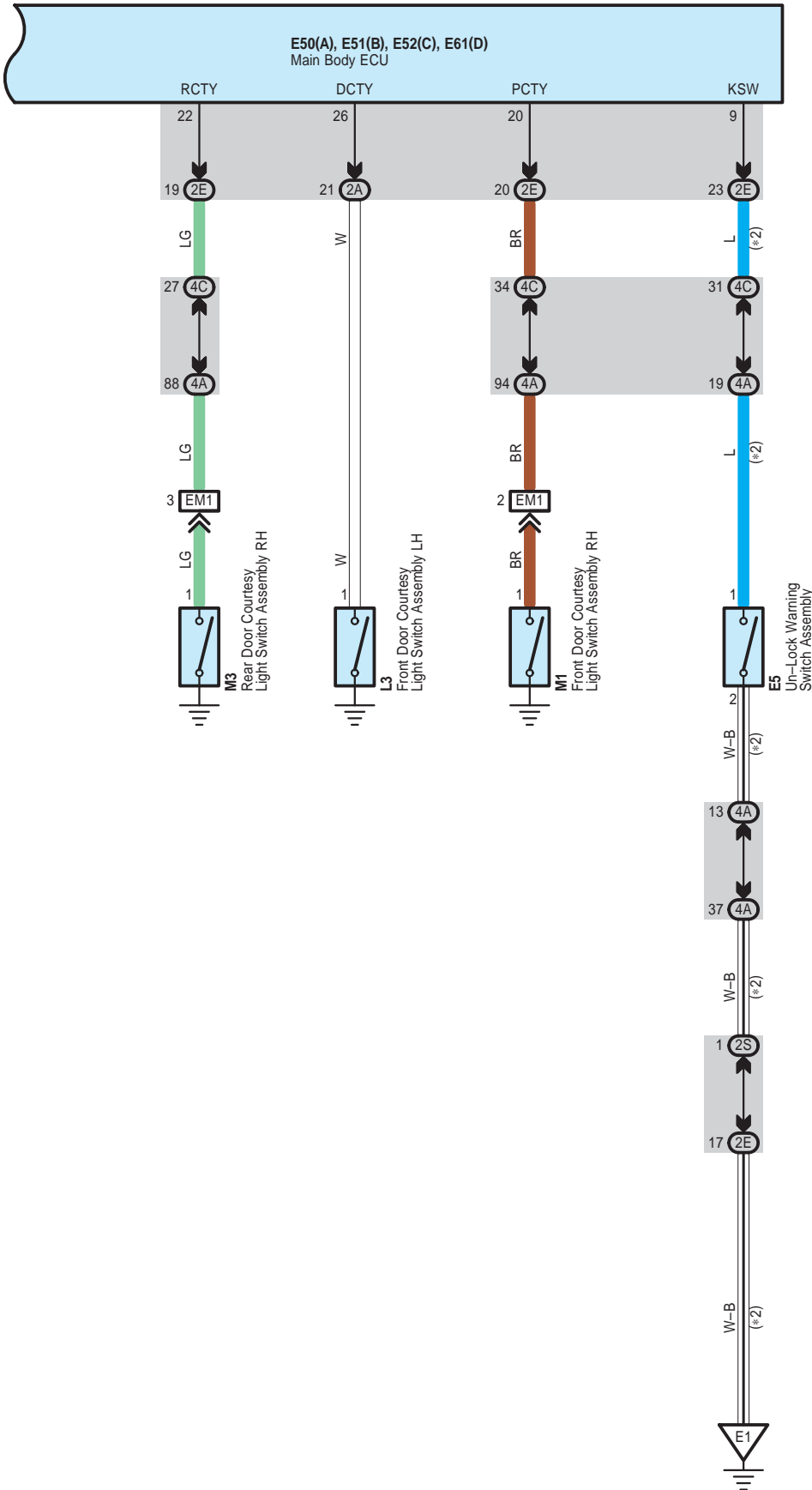

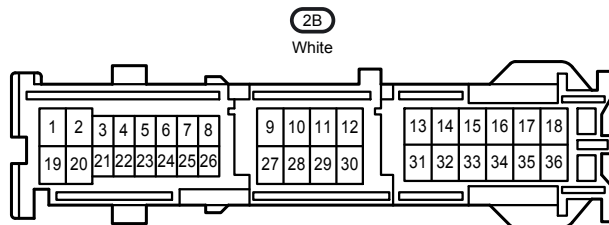
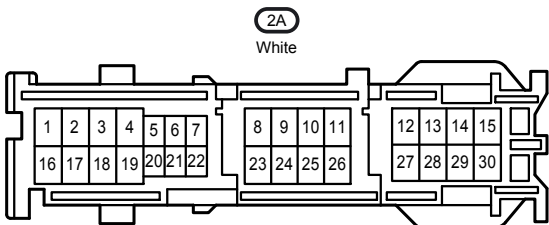
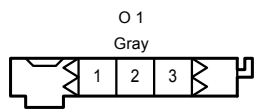
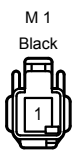
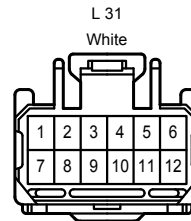
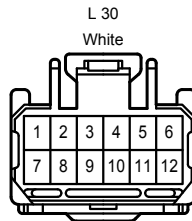
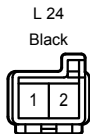
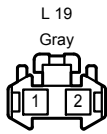
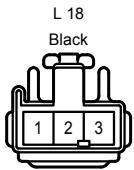
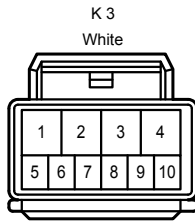
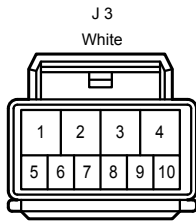
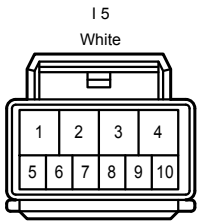
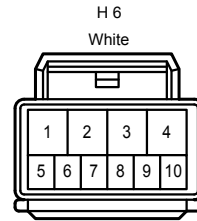
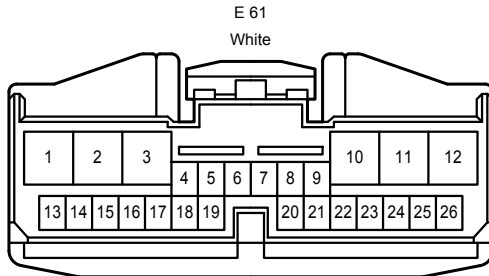
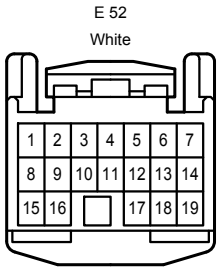
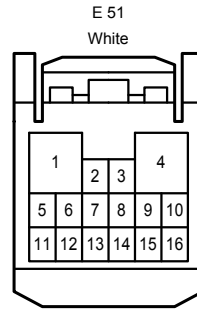
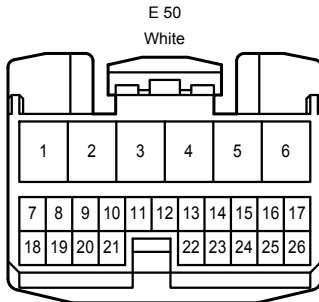
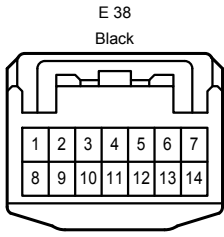



Interior Light <TMC Made>

2E  
White

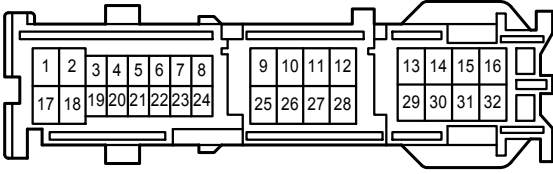

2K  
White

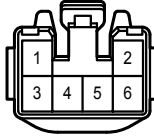

2S  
White

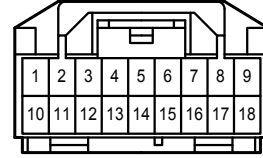

3A  
White

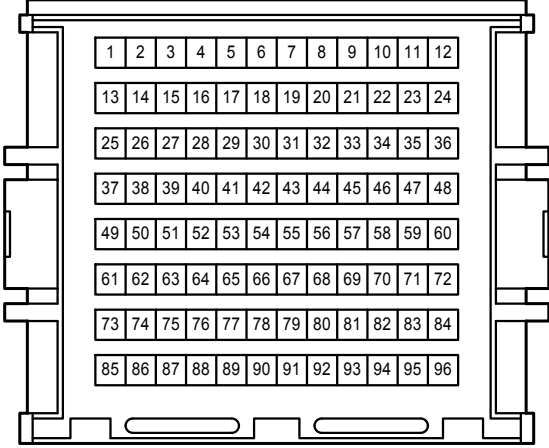

3B  
White

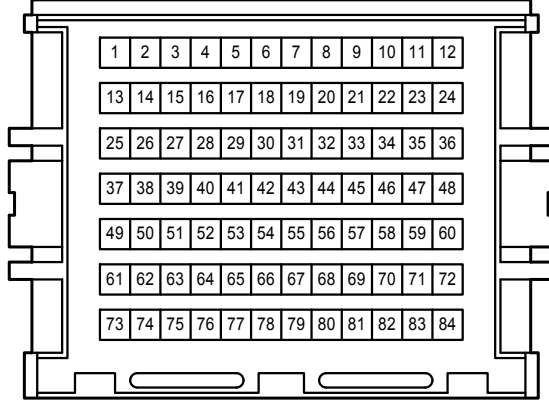

4A  
White

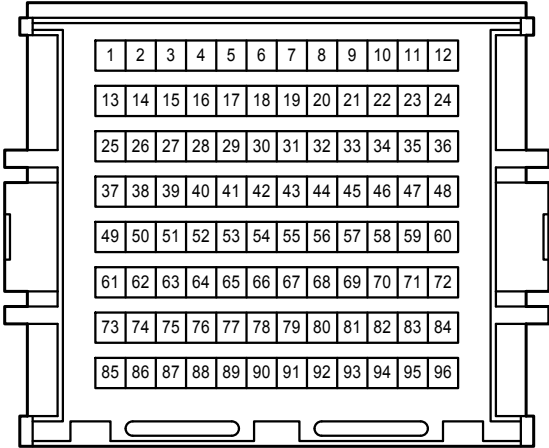

4C  
White

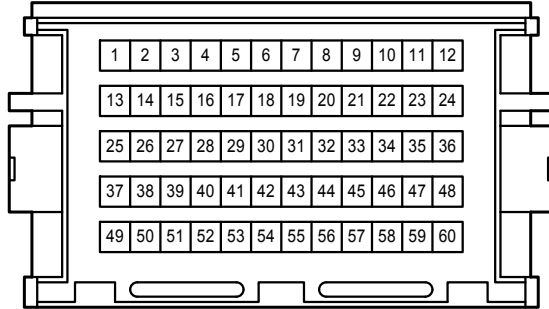

AE3  
White

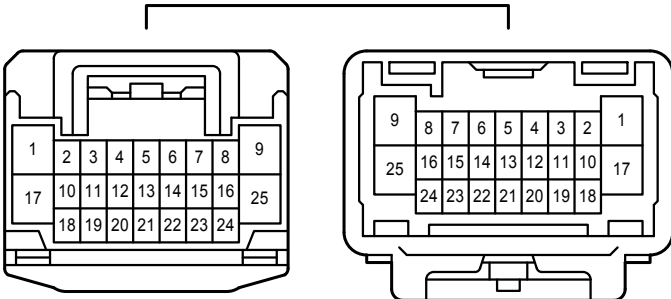

EL1  
White

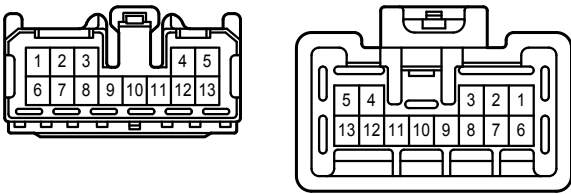

EL2  
White

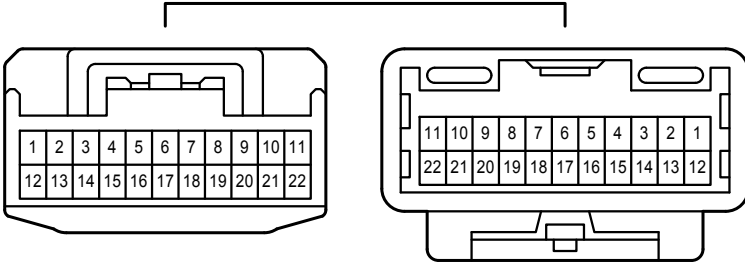

EM1  
Gray

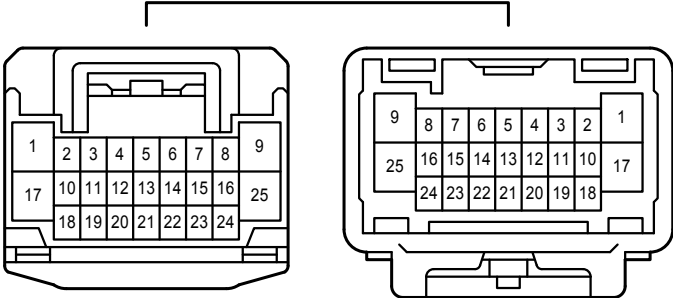

HE1  
Blue

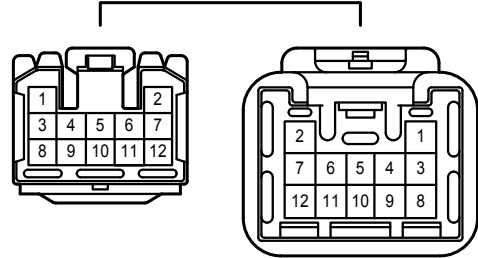

IE1  
Blue

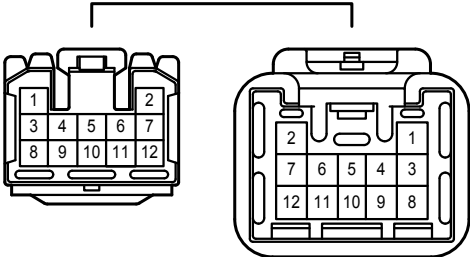

Interior Light <TMC Made>

JM1  
White

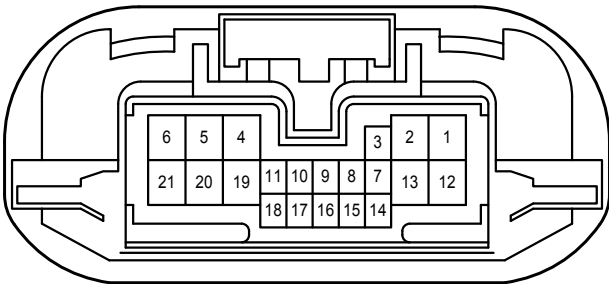
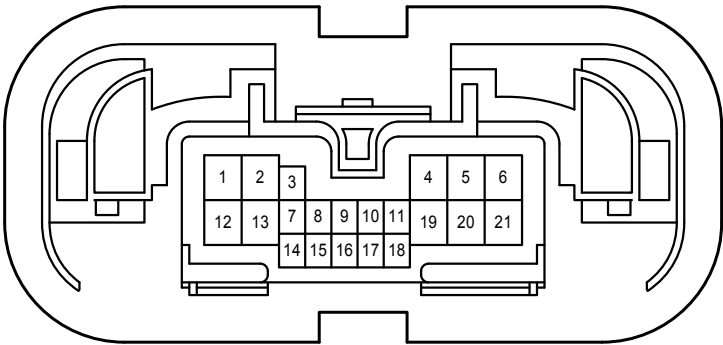

KL1  
White

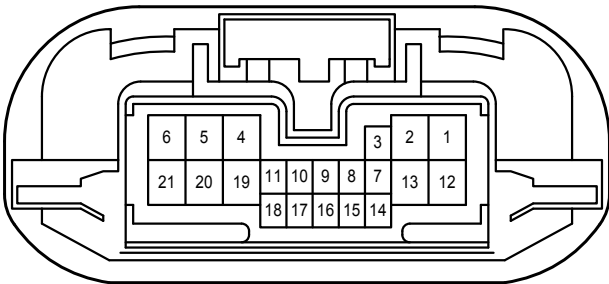
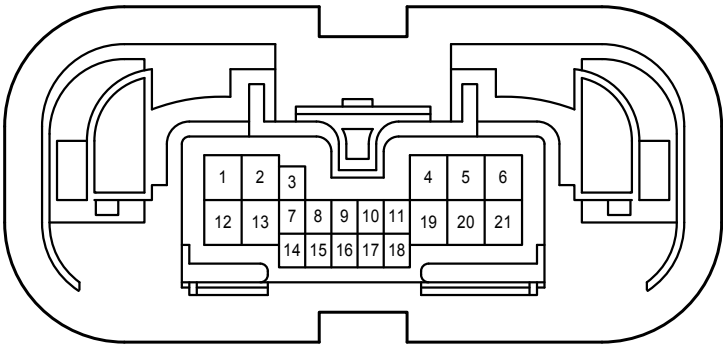

Key Reminder <w/o Smart Key System , TMC Made>

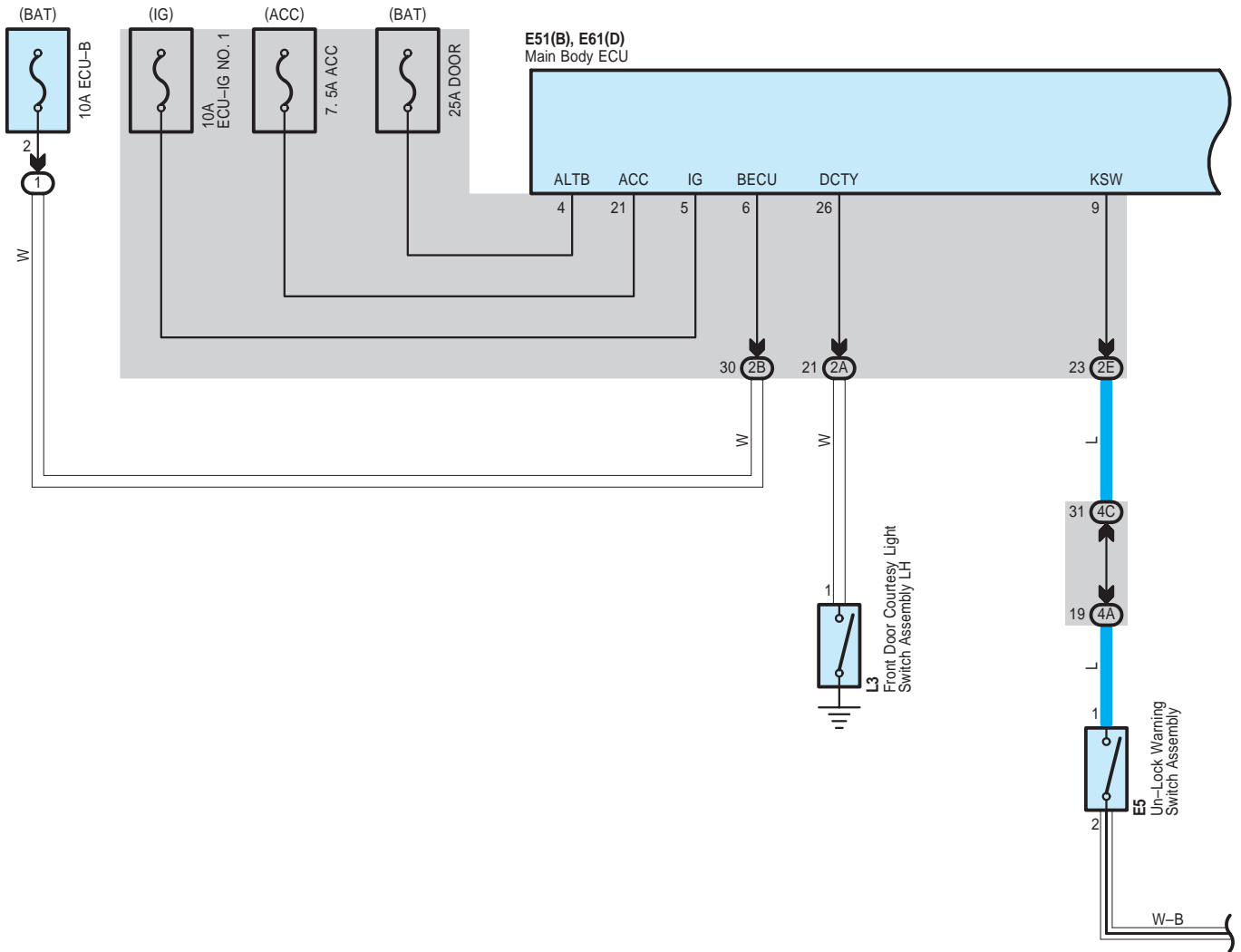

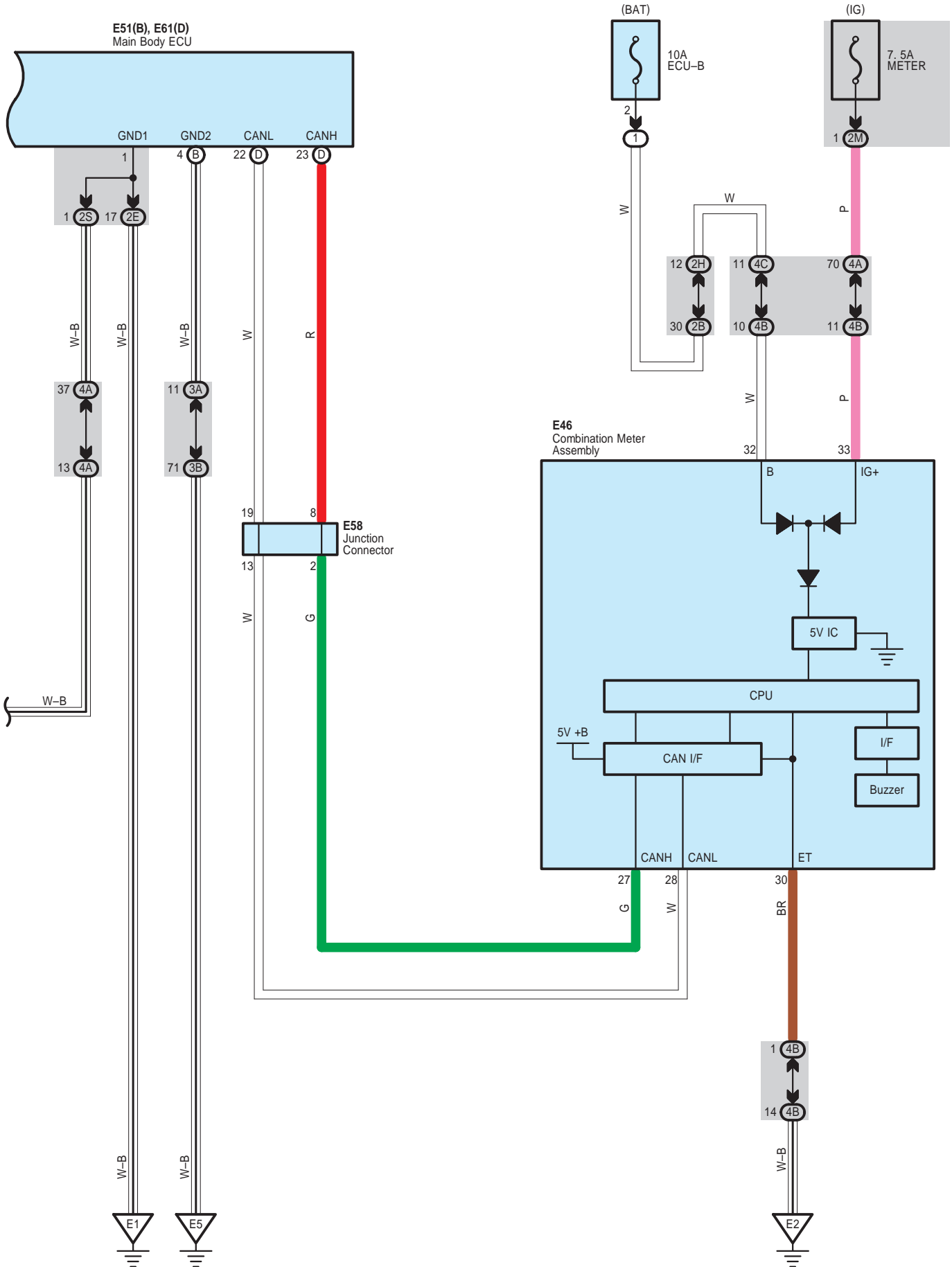

Key Reminder <w/o Smart Key System , TMC Made>

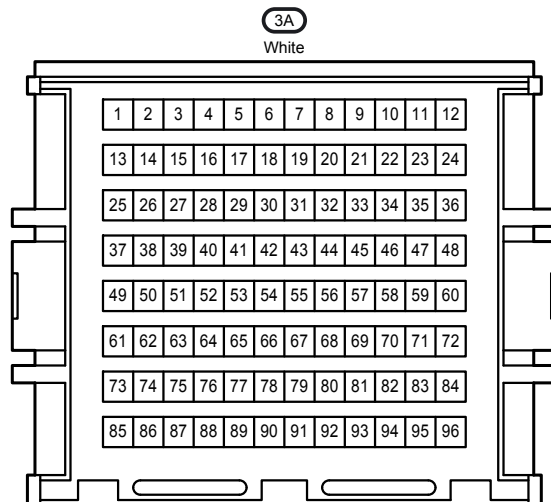
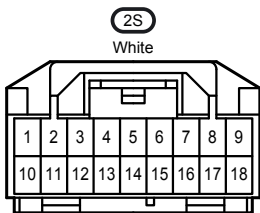
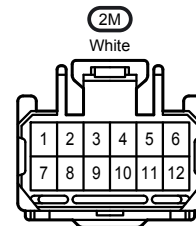
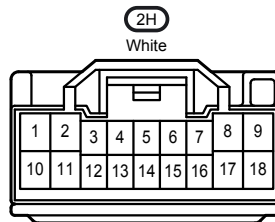
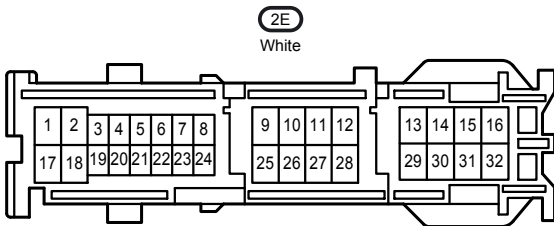
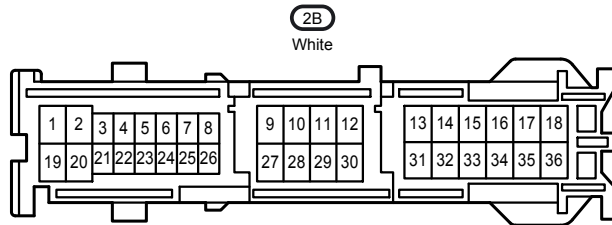
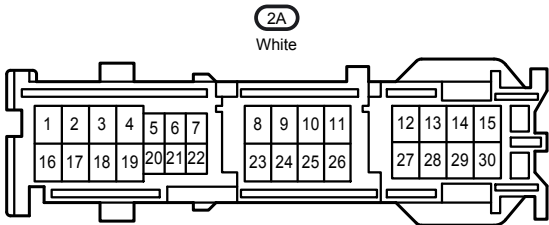
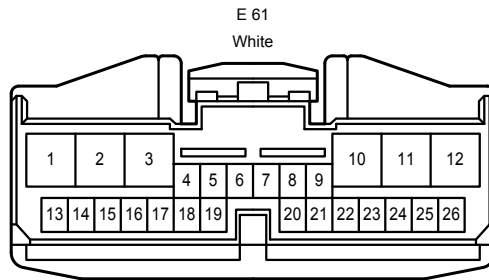
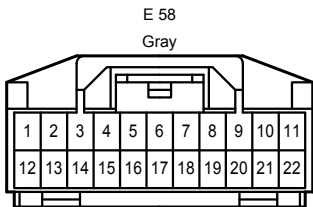
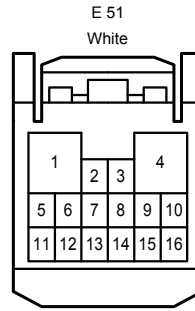
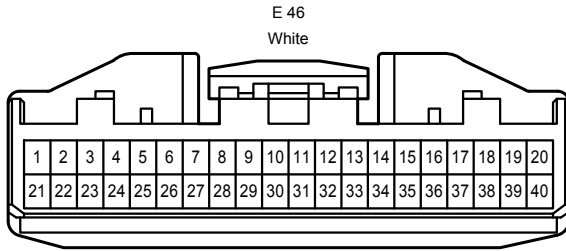
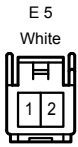

3B  
White

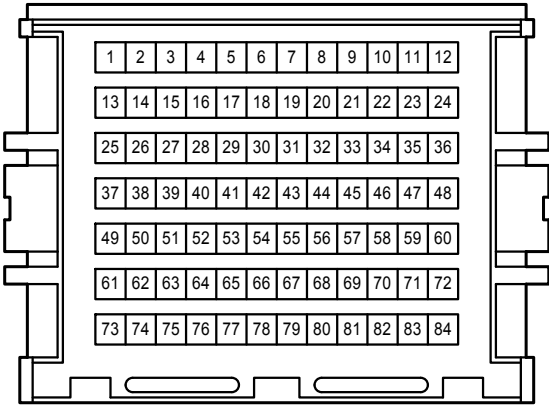

4A  
White

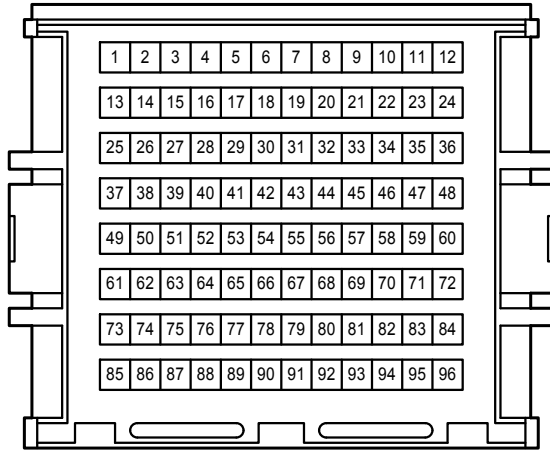

4B  
White

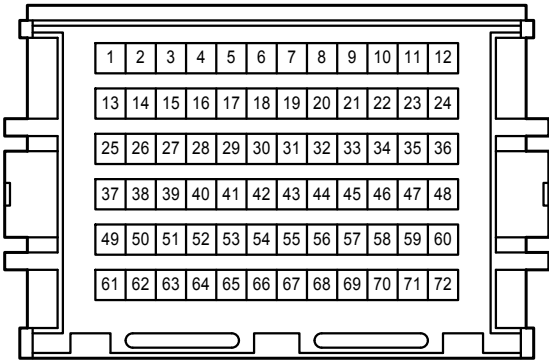

4C  
White

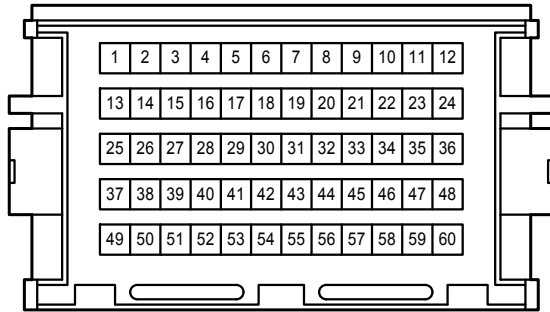

Light Reminder <Except TMC Made>

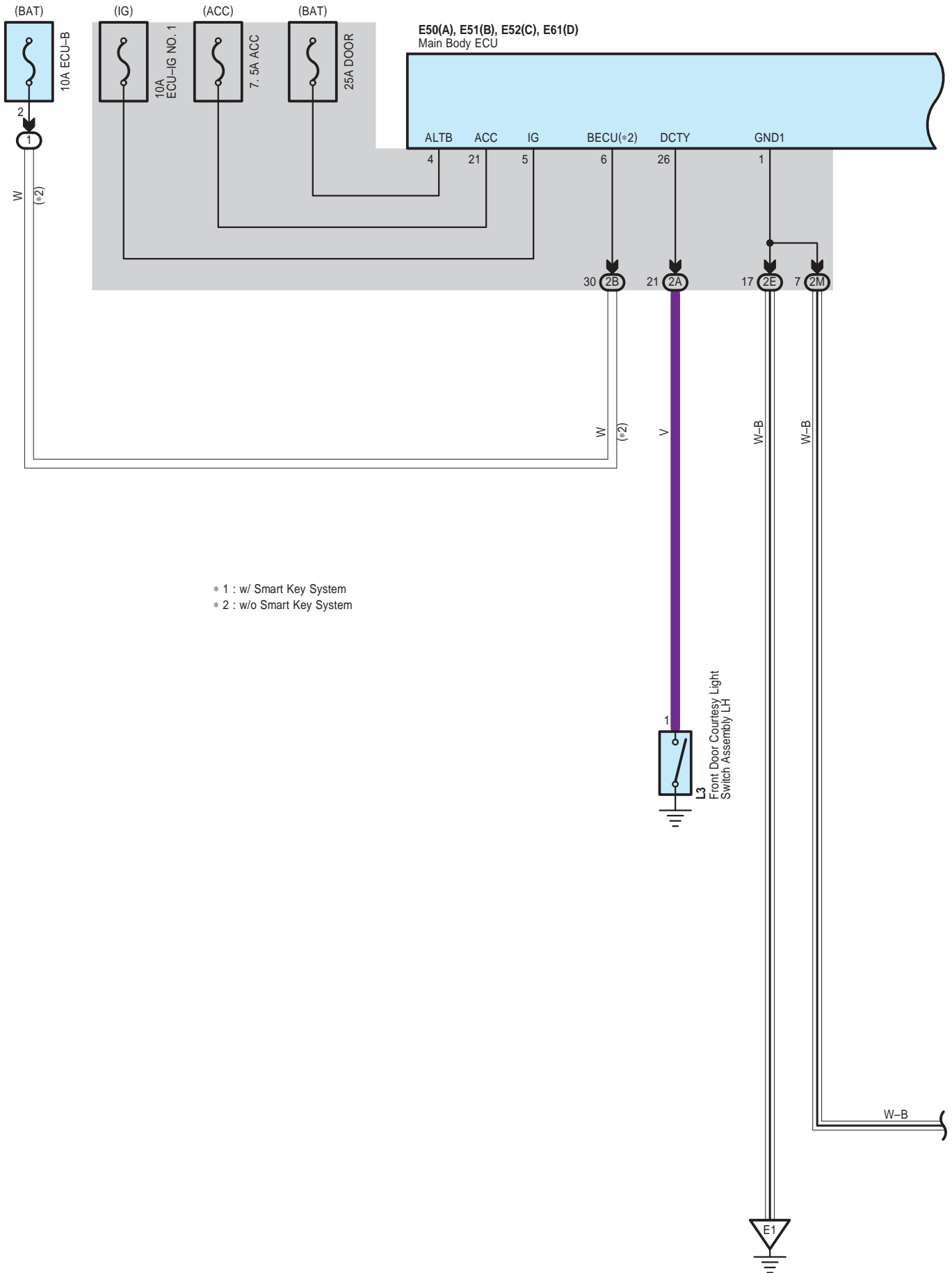

\* 1 : w/ Smart Key System  
 \* 2 : w/o Smart Key System



E50(A), E51(B), E52(C), E61(D)  
Main Body ECU

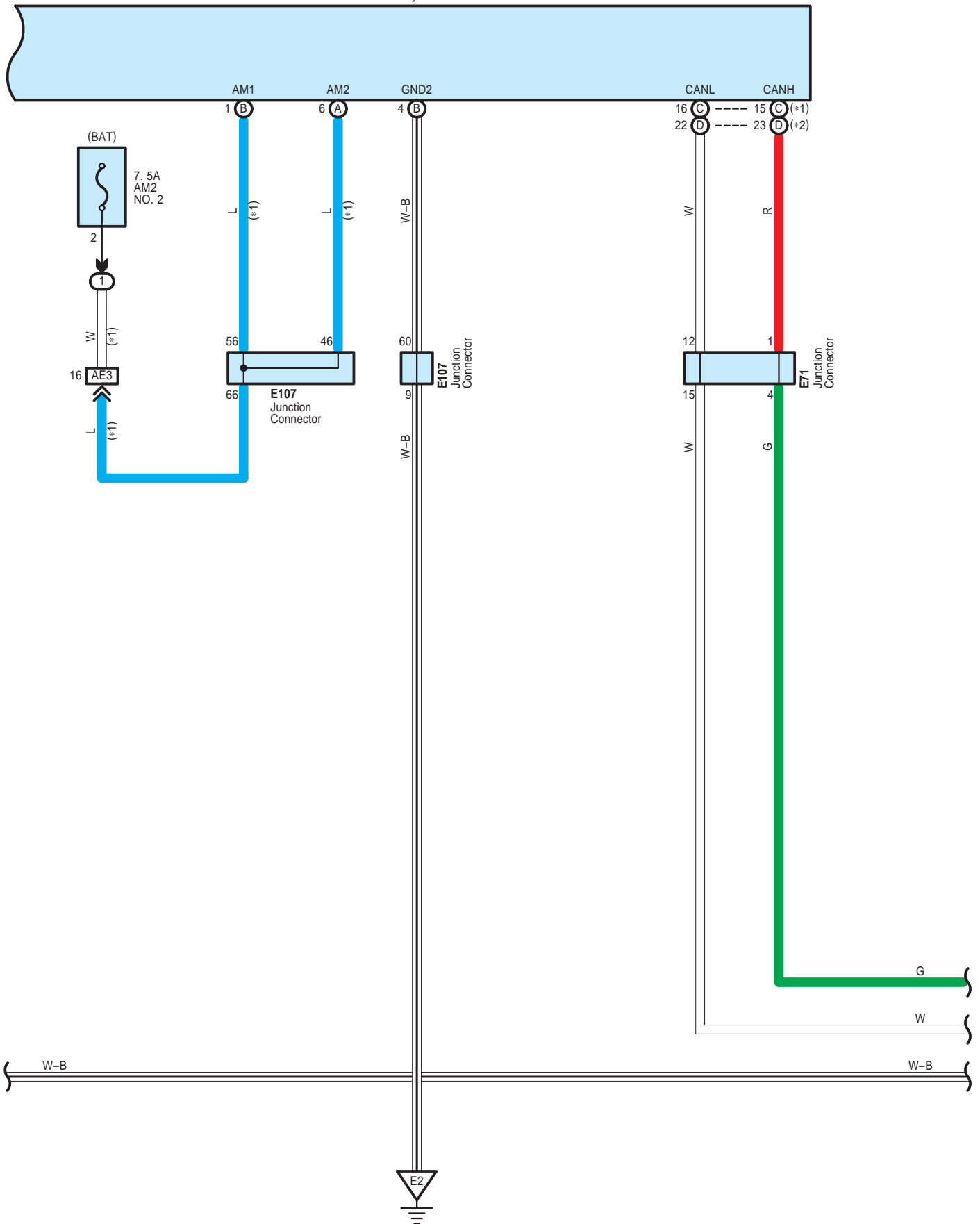

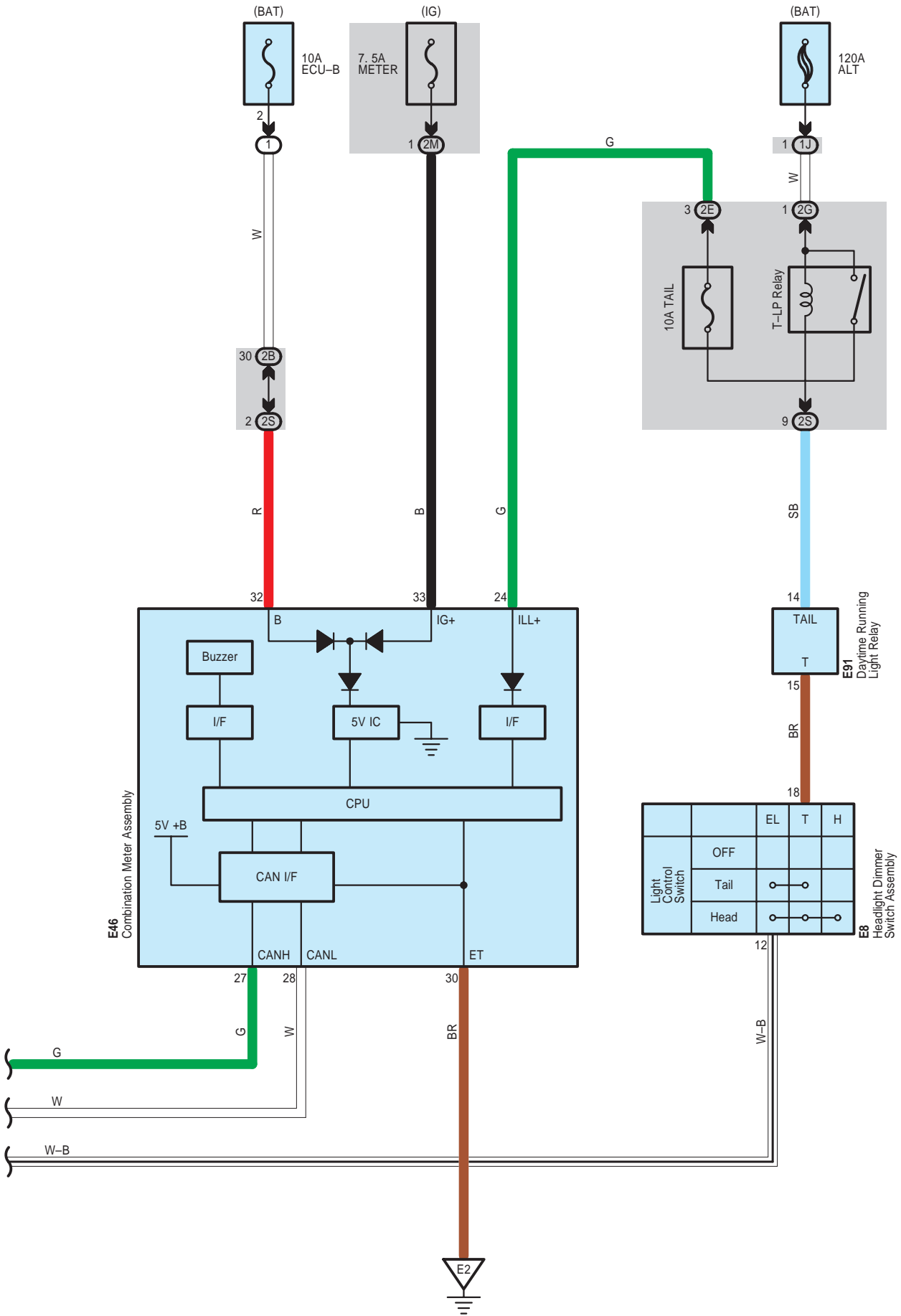

Light Reminder <Except TMC Made>

E 8  
White

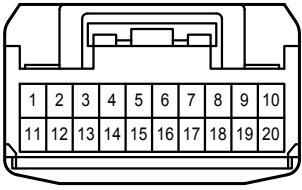

E 46  
White

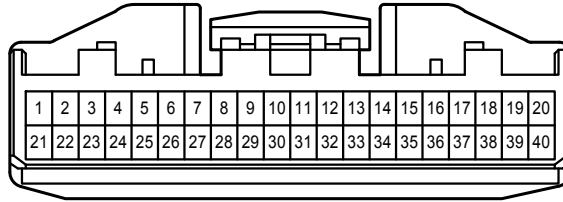

E 50  
White

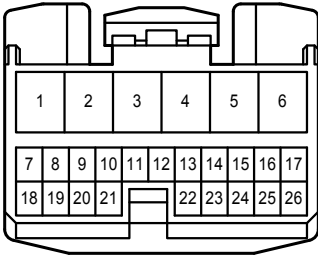

E 51  
White

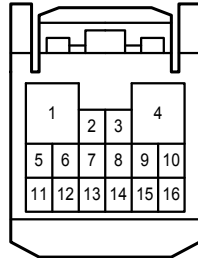

E 52  
White

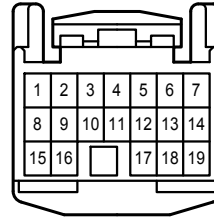

E 61  
White

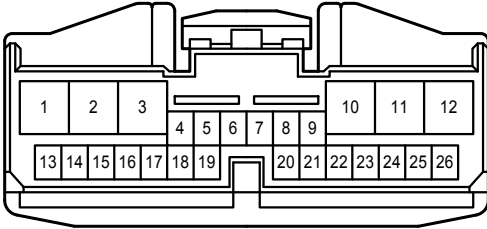

E 71  
White

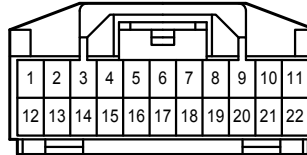

E 91  
White

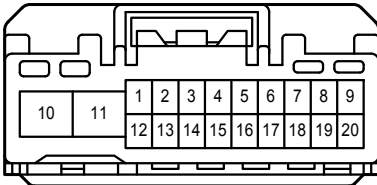

E107  
White

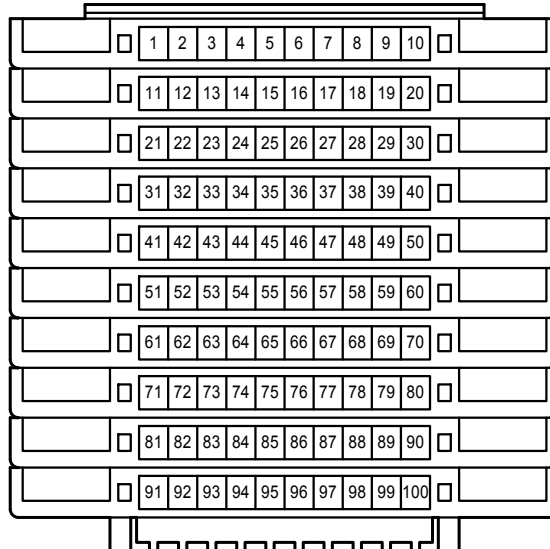

L 3  
Black



1J

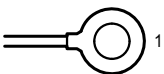

2A

White

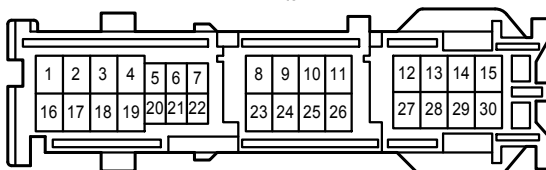

2B  
White

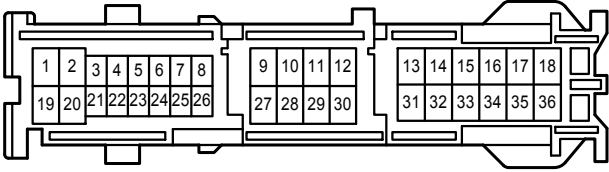

2E  
White

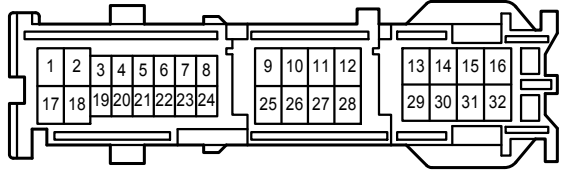

2G  
White

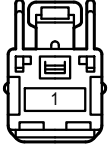

2M  
White

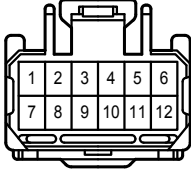

2S  
White

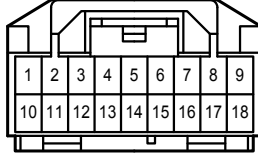

AE3  
White

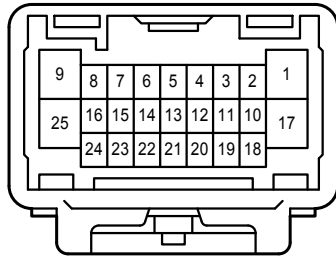
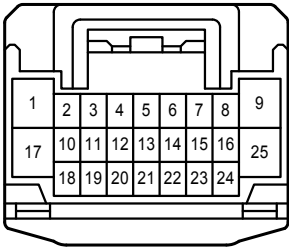

Light Reminder <TMC Made>

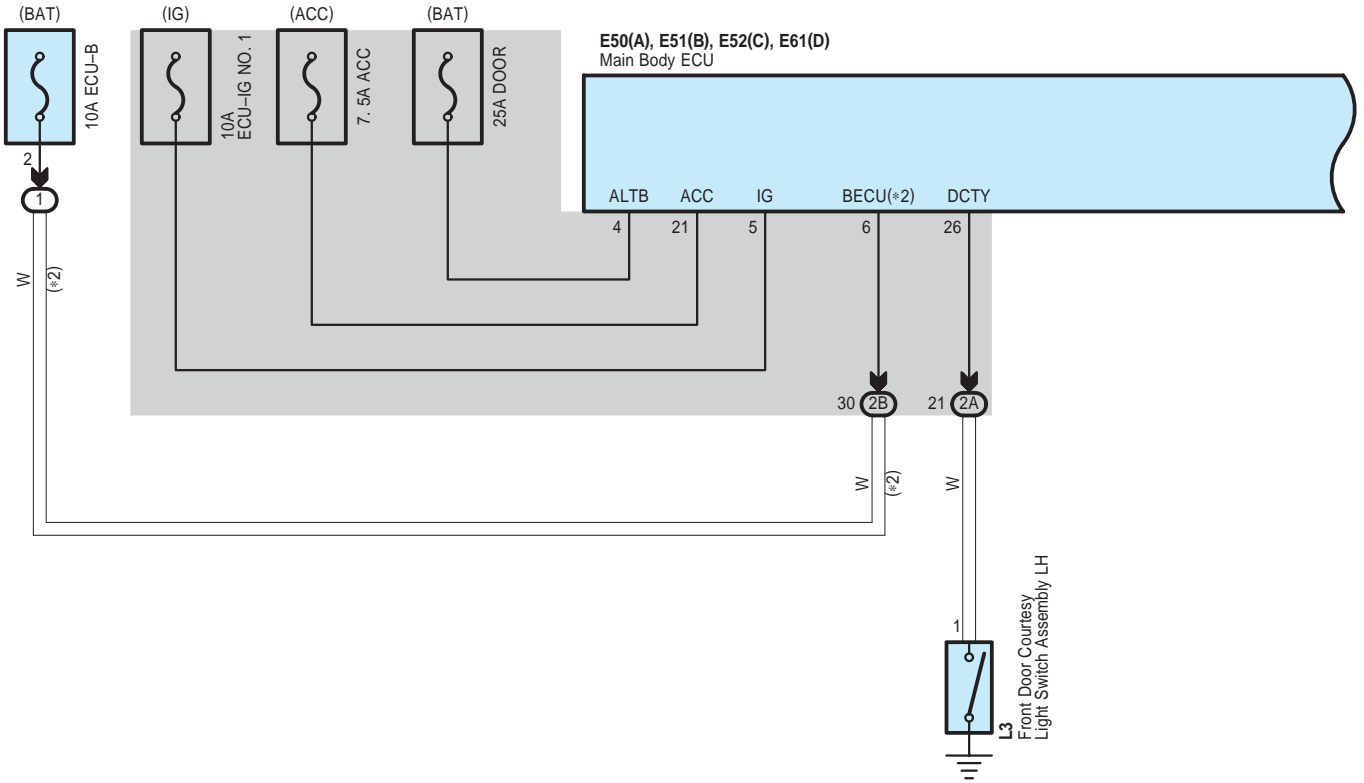

\* 1 : w/ Smart Key System  
\* 2 : w/o Smart Key System

E50(A), E51(B), E52(C), E61(D)  
Main Body ECU

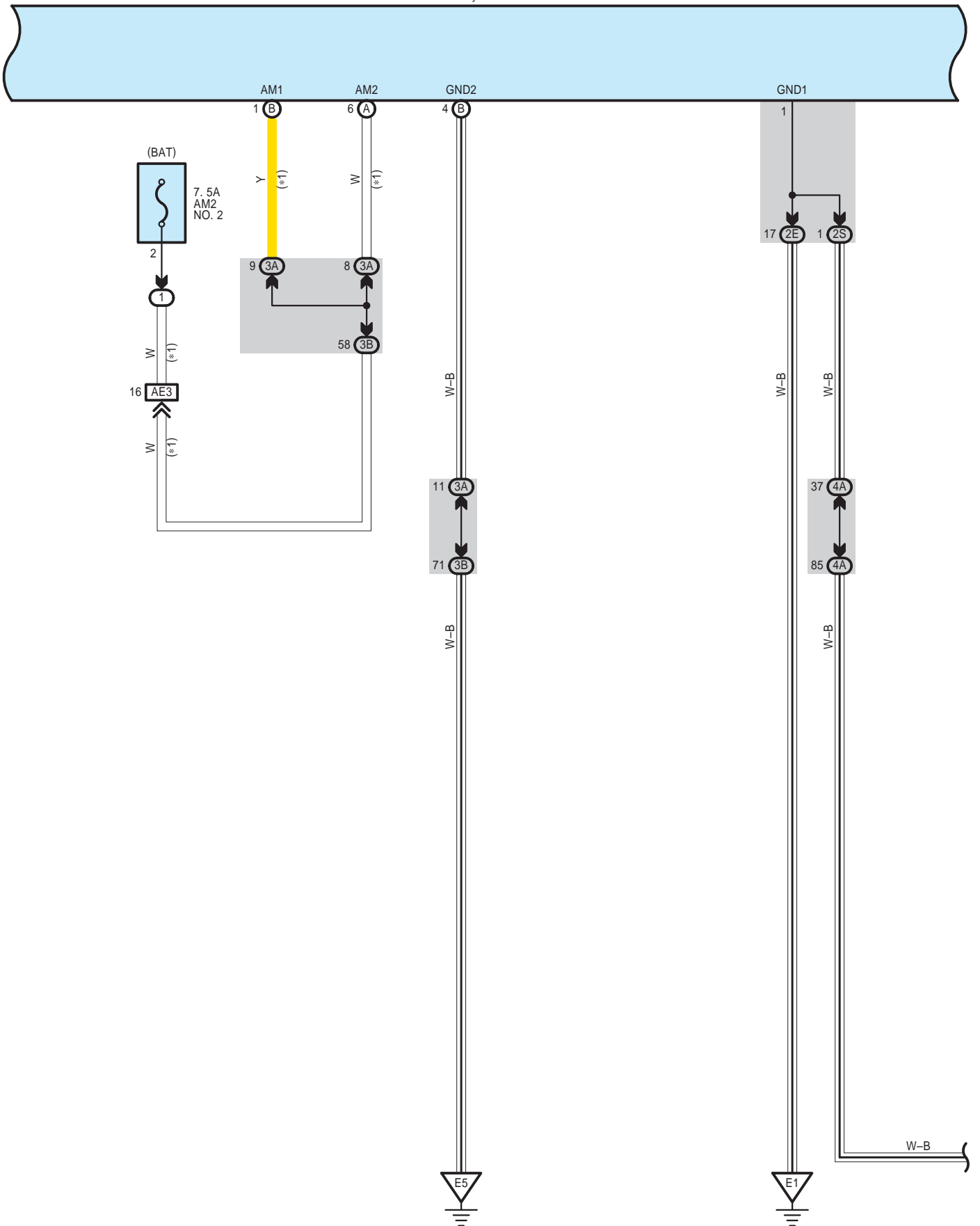

# Light Reminder <TMC Made>

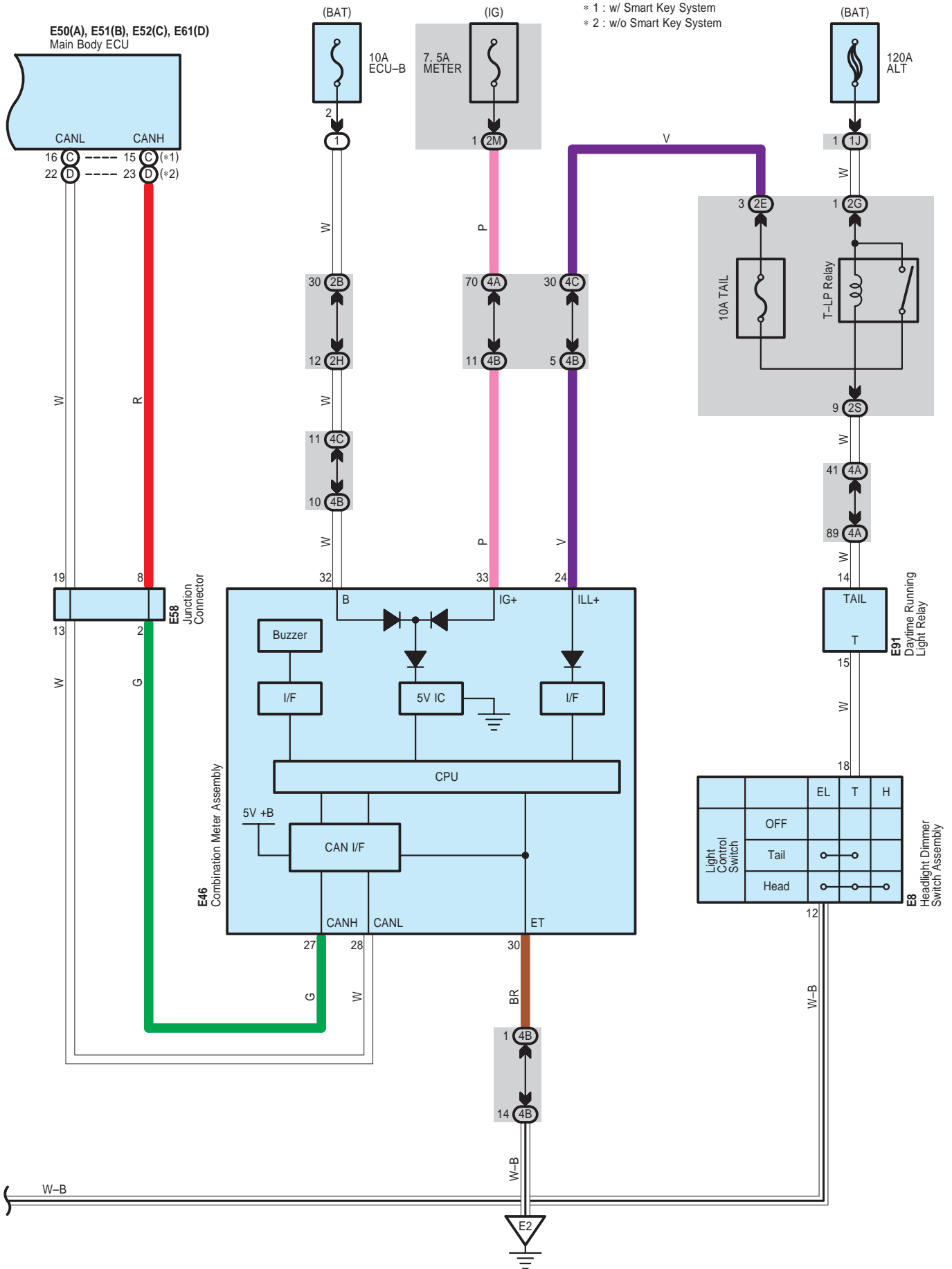

Light Reminder <TMC Made>

E 8  
White

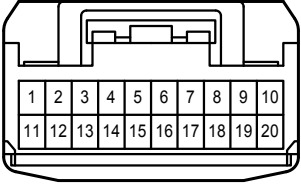

E 46  
White

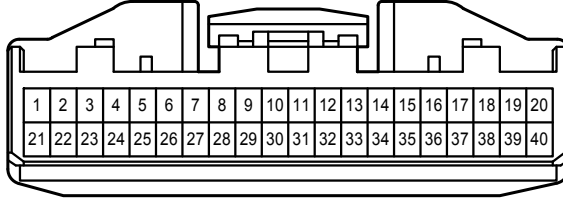

E 50  
White

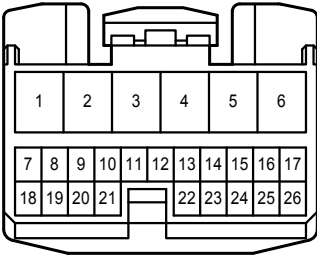

E 51  
White

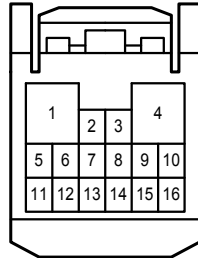

E 52  
White

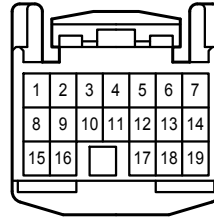

E 58  
Gray

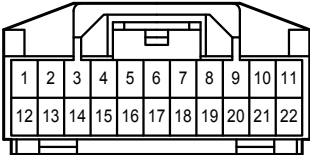

E 61  
White

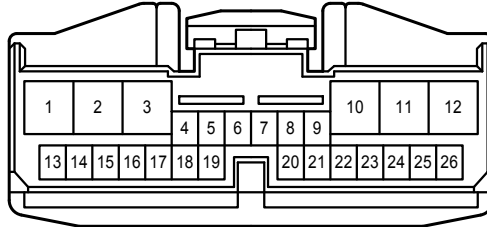

E 91  
White

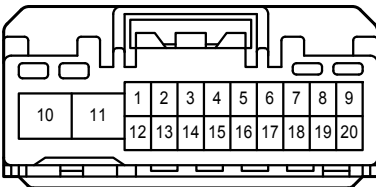

L 3  
Black



1J

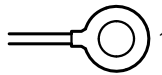

2A  
White

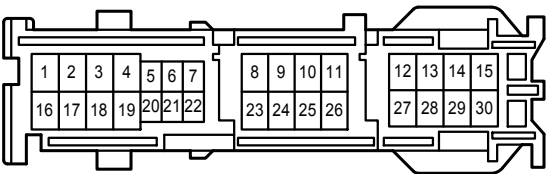

2B  
White

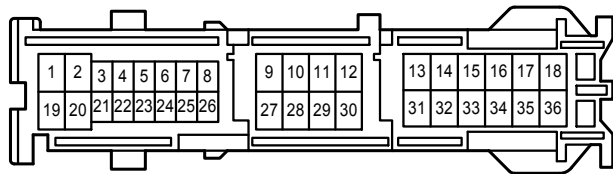

2E  
White

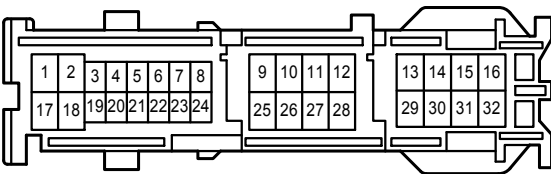

2G  
White

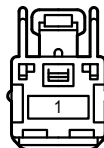

2H  
White

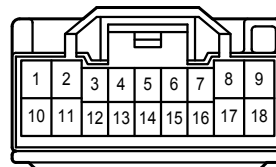



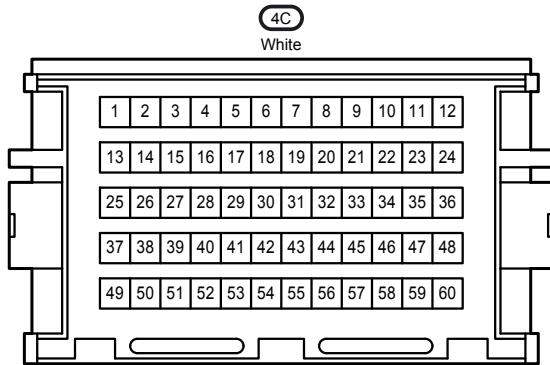
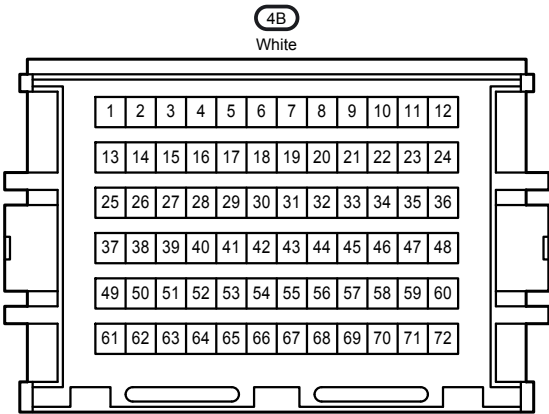
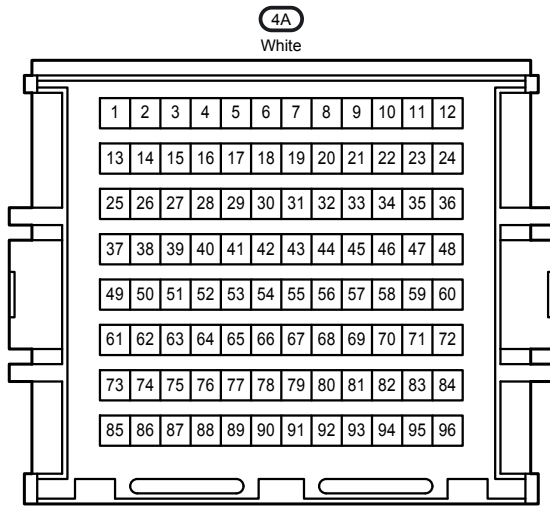
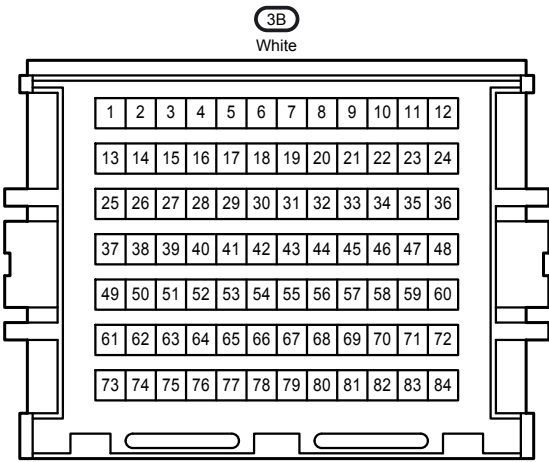
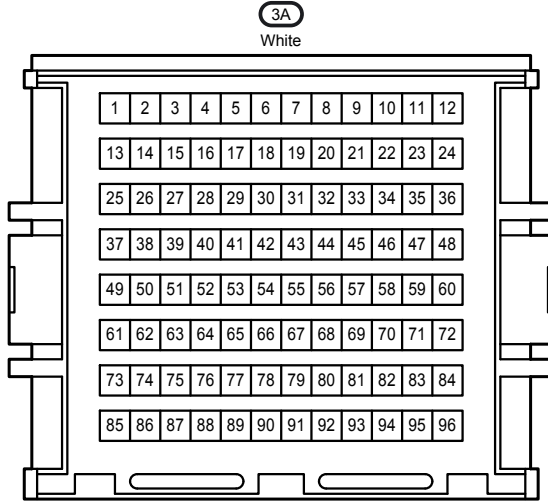
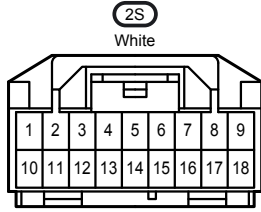
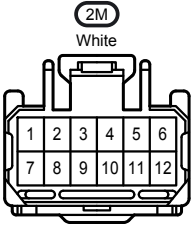

AE3  
White

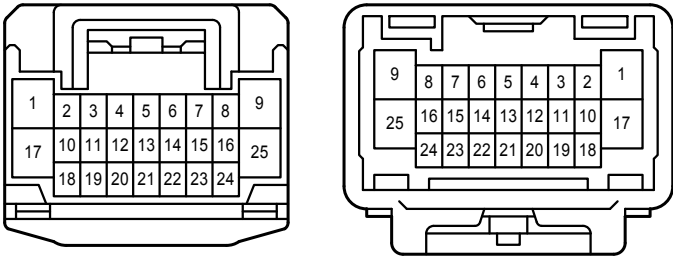

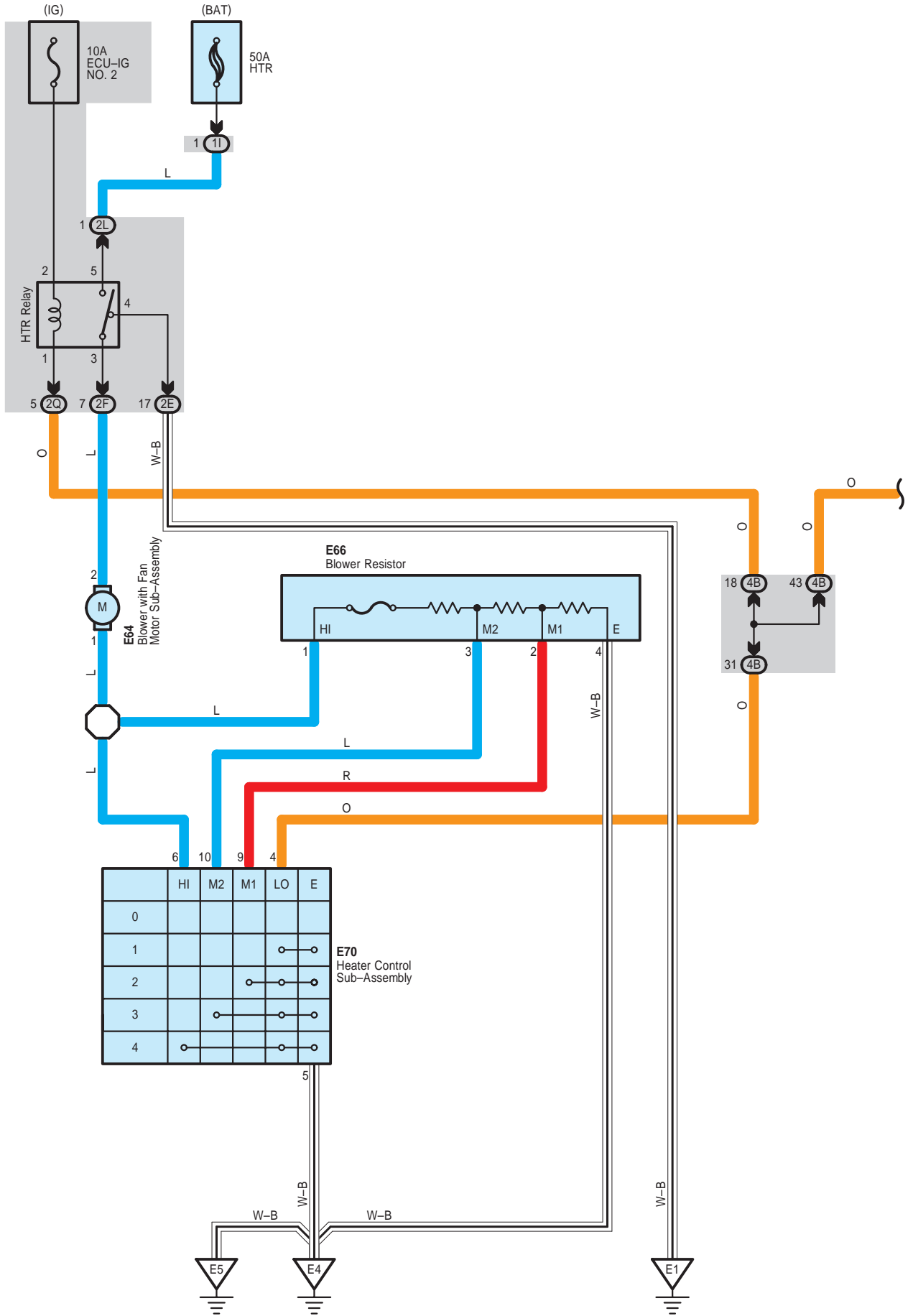

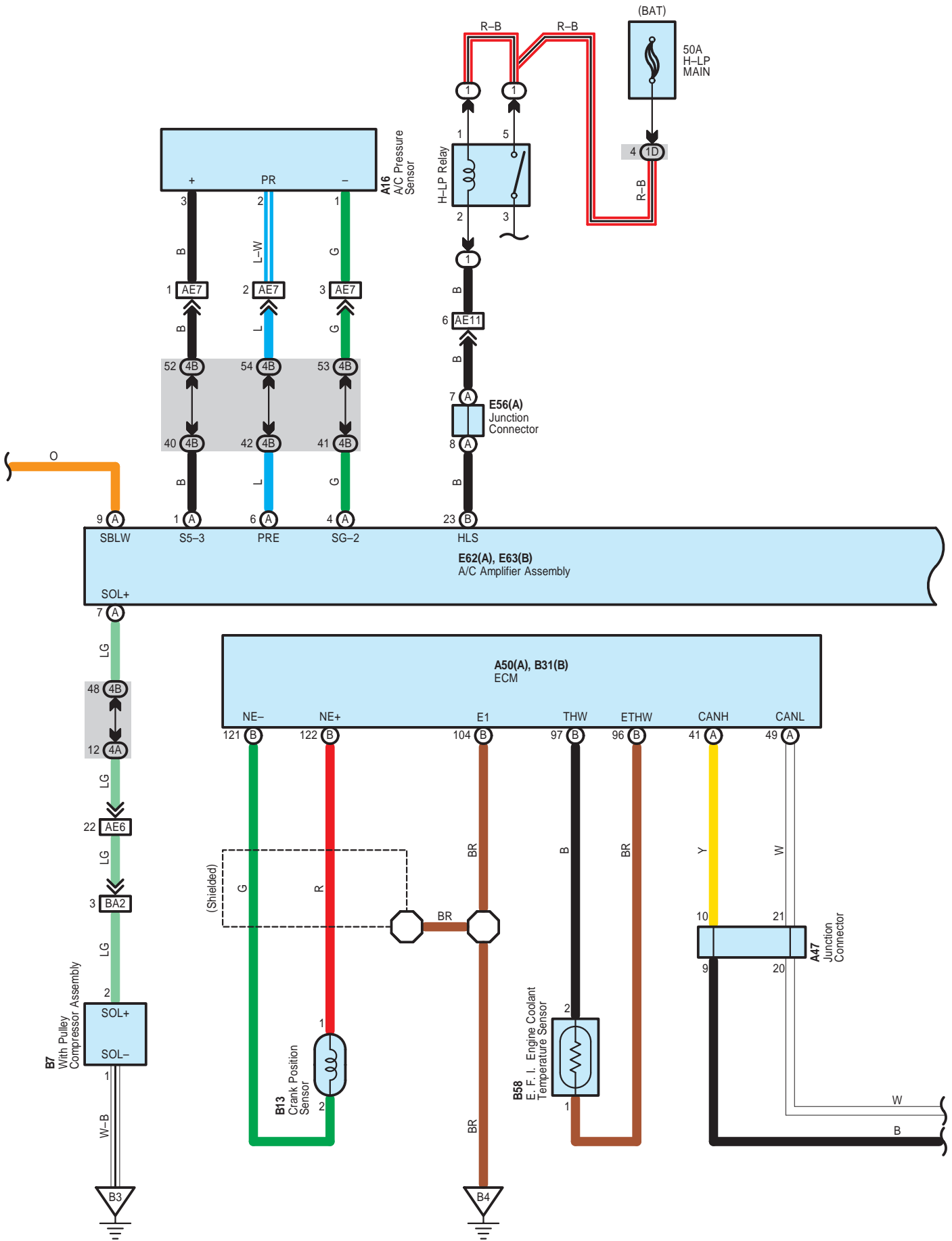

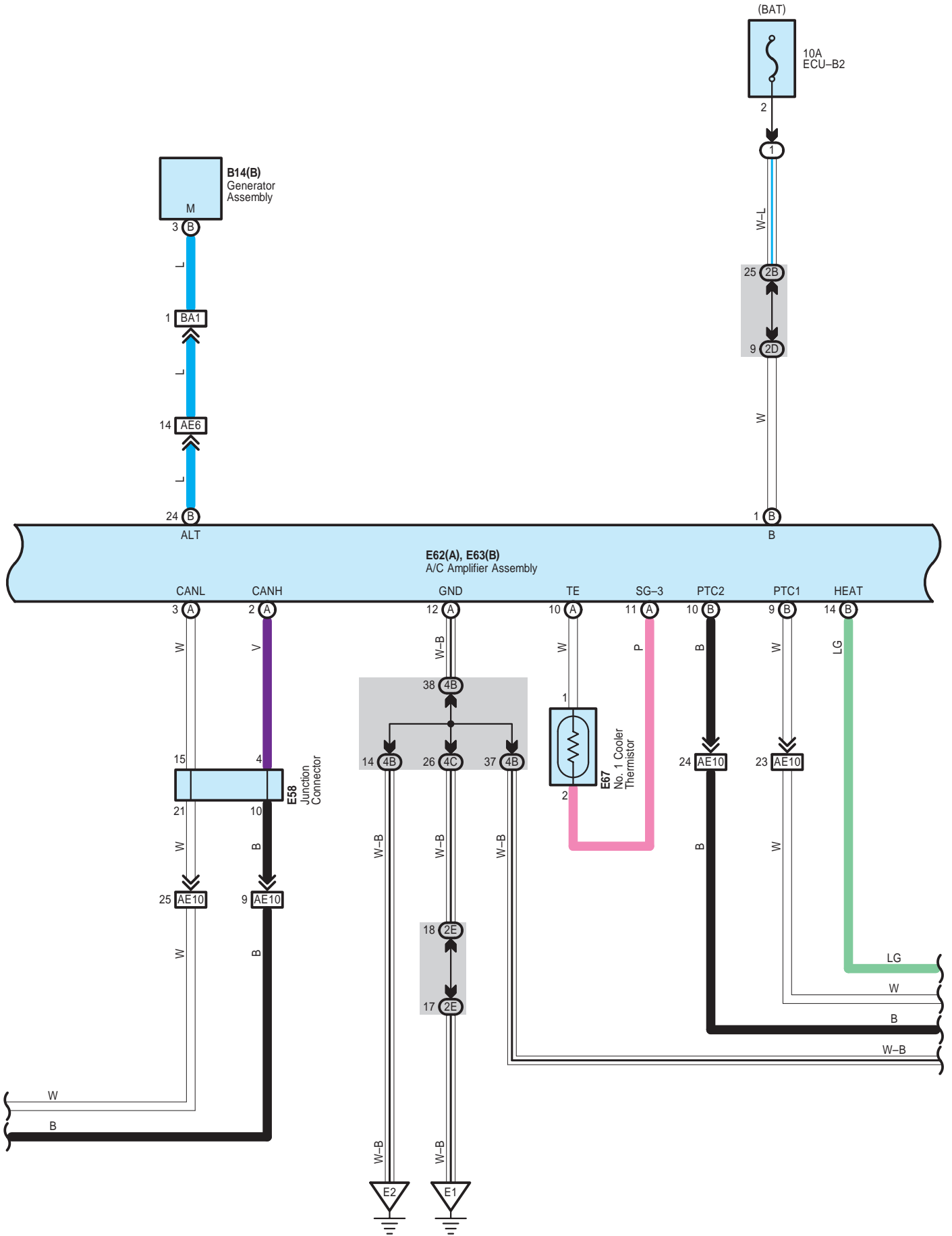

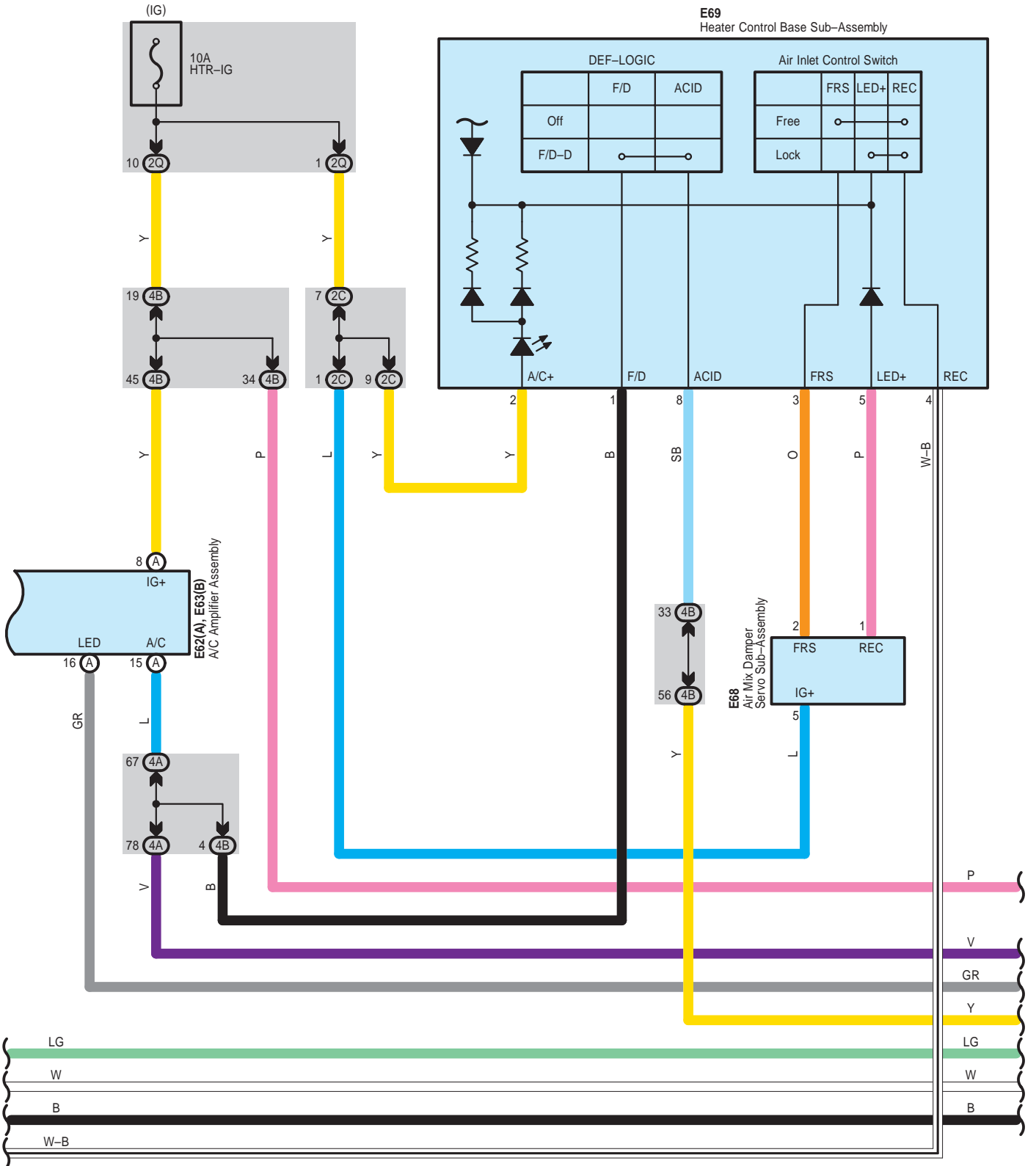

E65  
No. 3 Heater Control Sub-Assembly

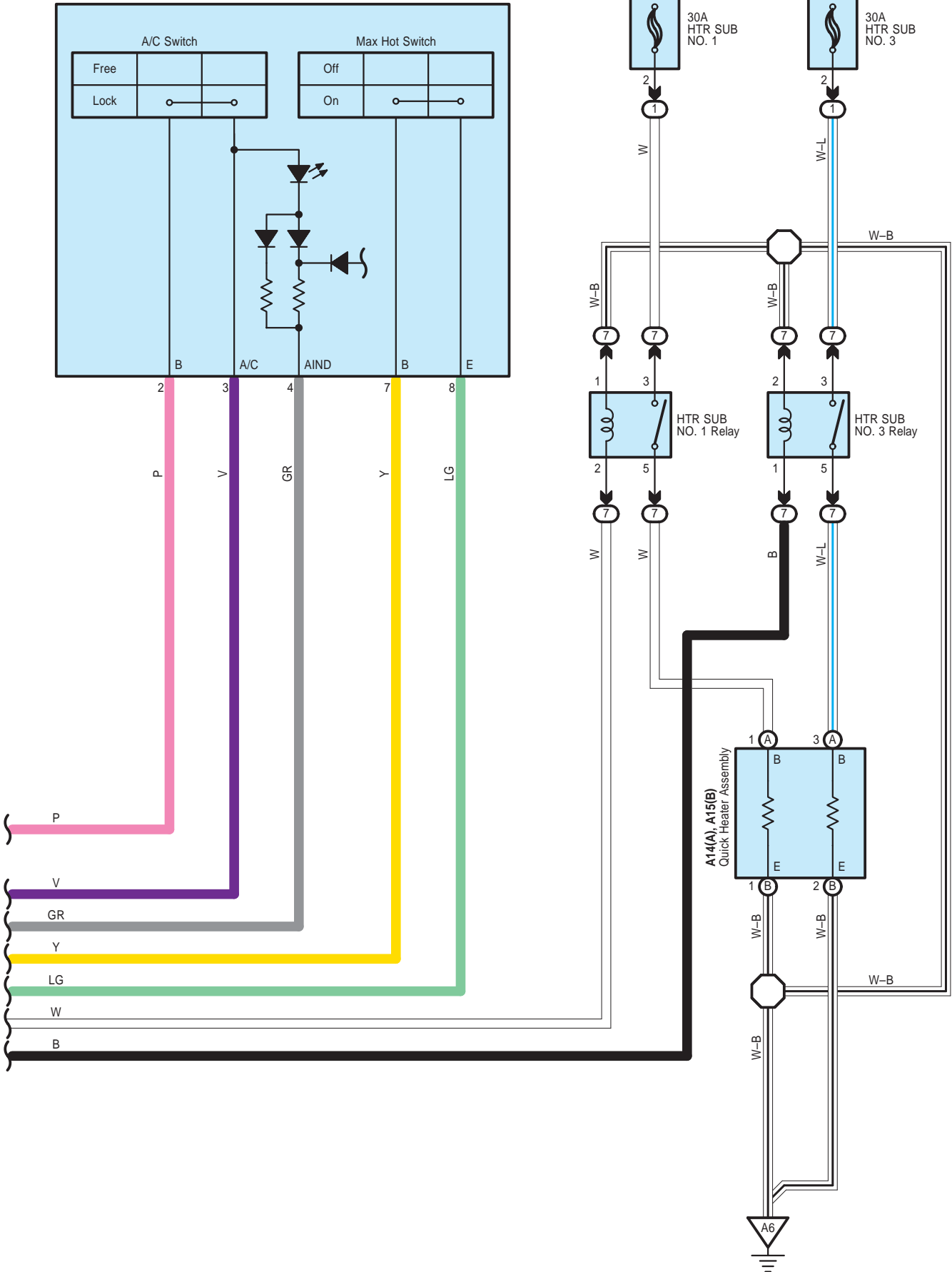

Manual Air Conditioning <TMC Made>

A 14

White

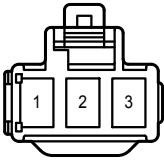

A 15

White

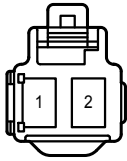

A 16

Black

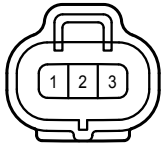

A 47

White

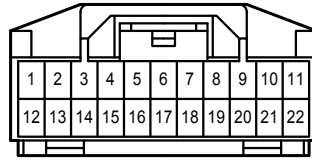

A 50

Black

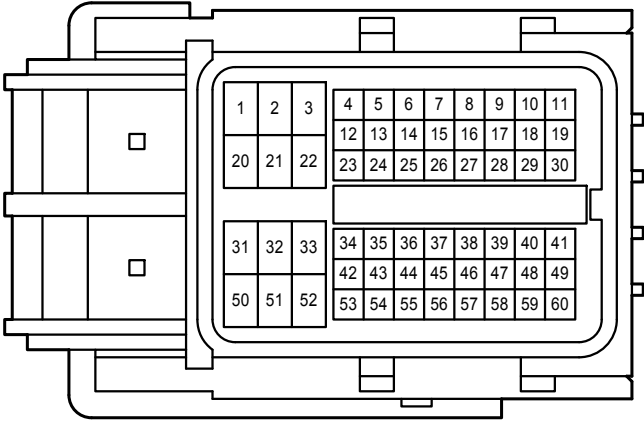

B 7

Black

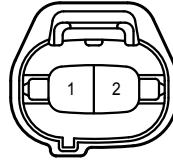

B 13

Black

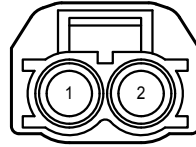

B 14

Black



B 31

Black

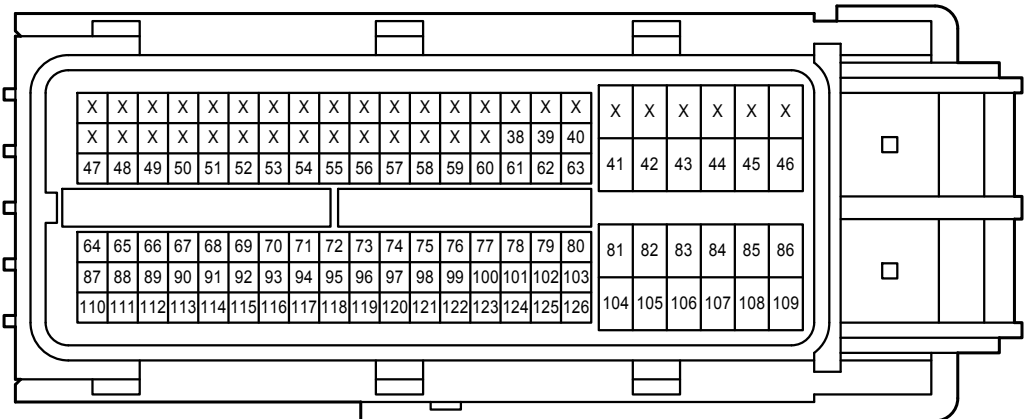

B 58

Gray



E 56

White

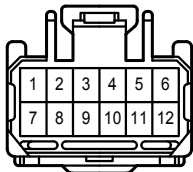

E 58

Gray

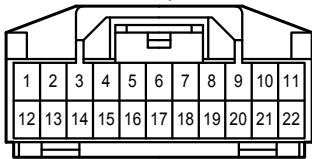

E 62

White

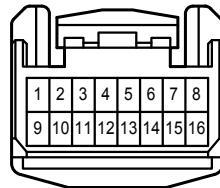

E 63

White

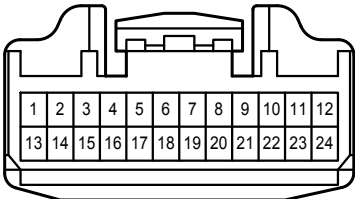

E 64

Black

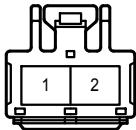

E 65

Black

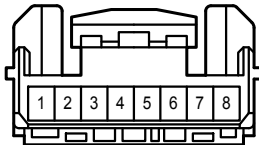

E 66

Black

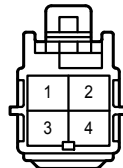



Manual Air Conditioning <TMC Made>

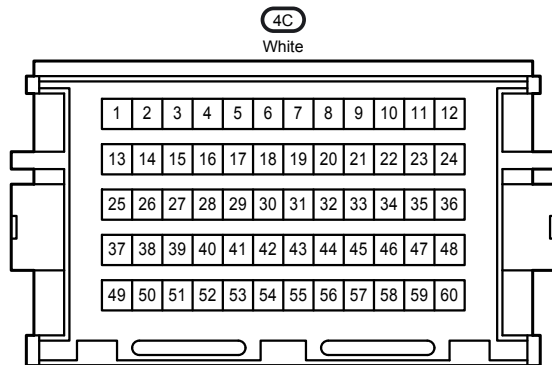
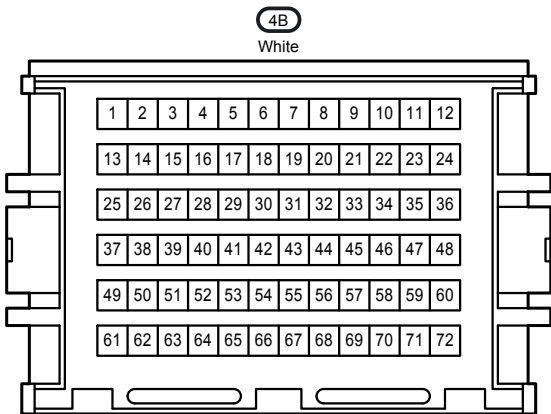
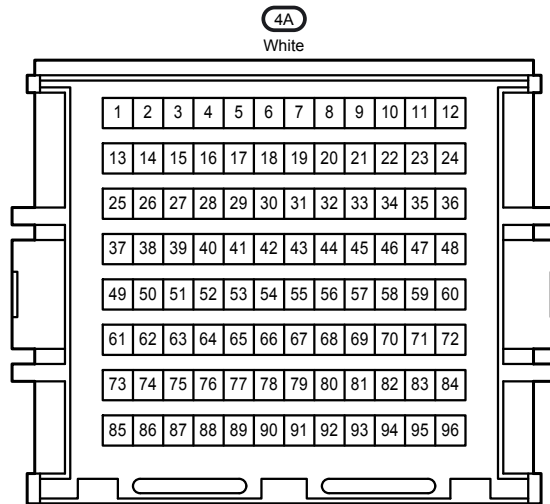
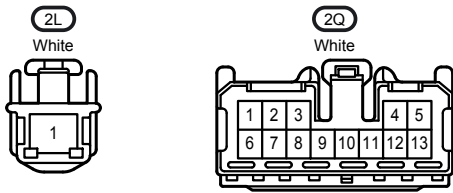
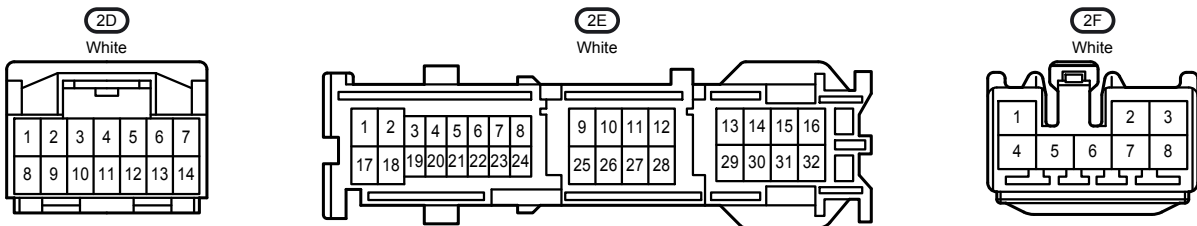
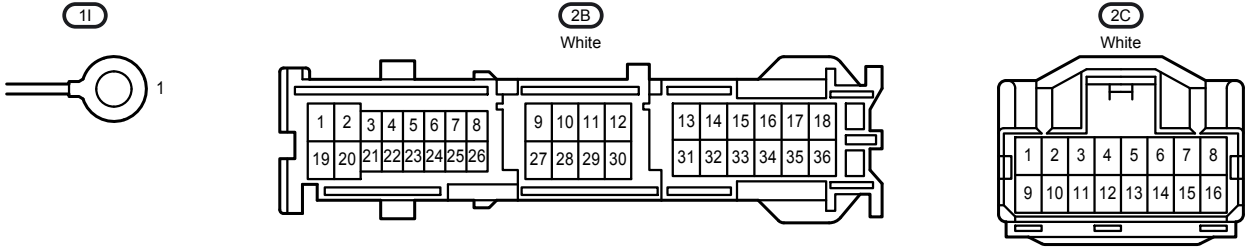
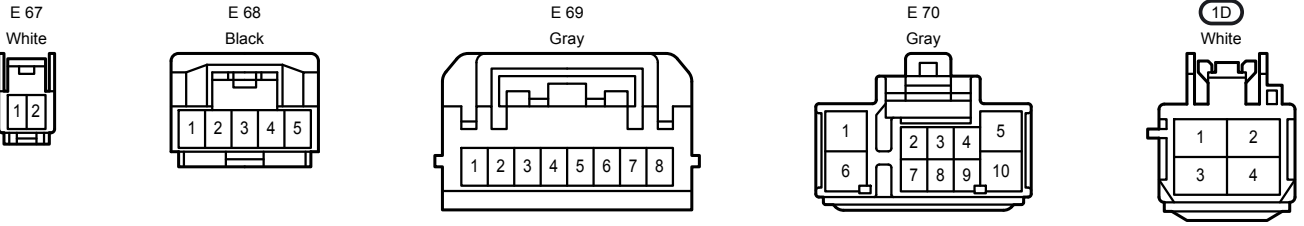

AE6  
Gray

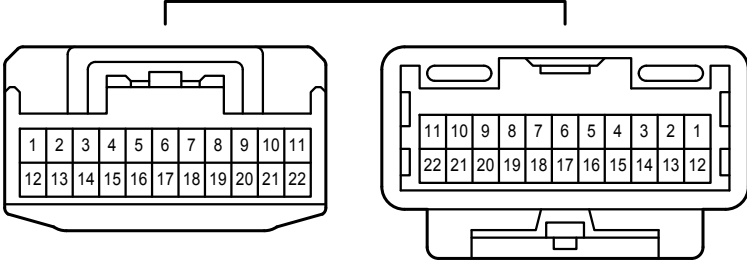

AE7  
Blue

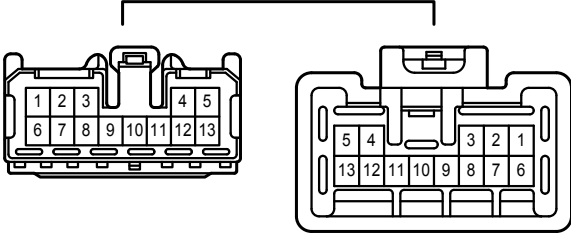

AE10  
Gray

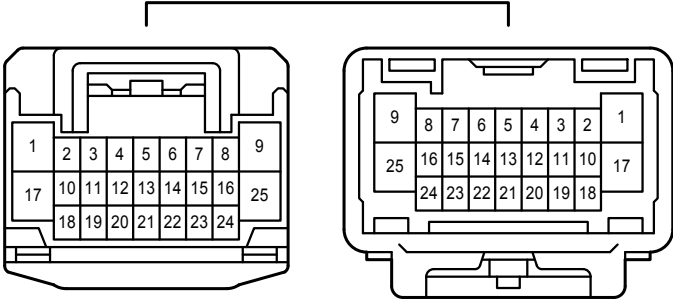

AE11  
White

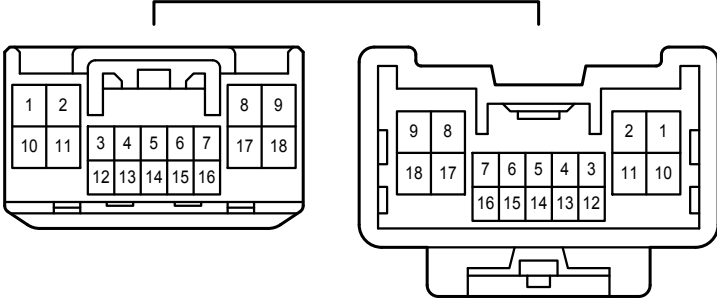

BA1  
White

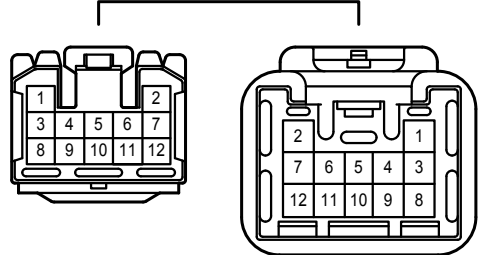

BA2  
White

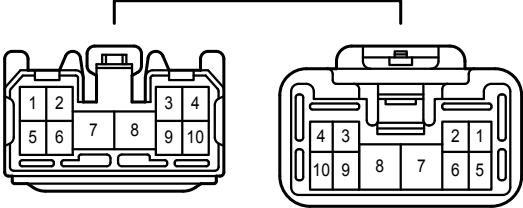

Mirror Heater <Except TMC Made> , Rear Window Defogger <Except TMC Made>

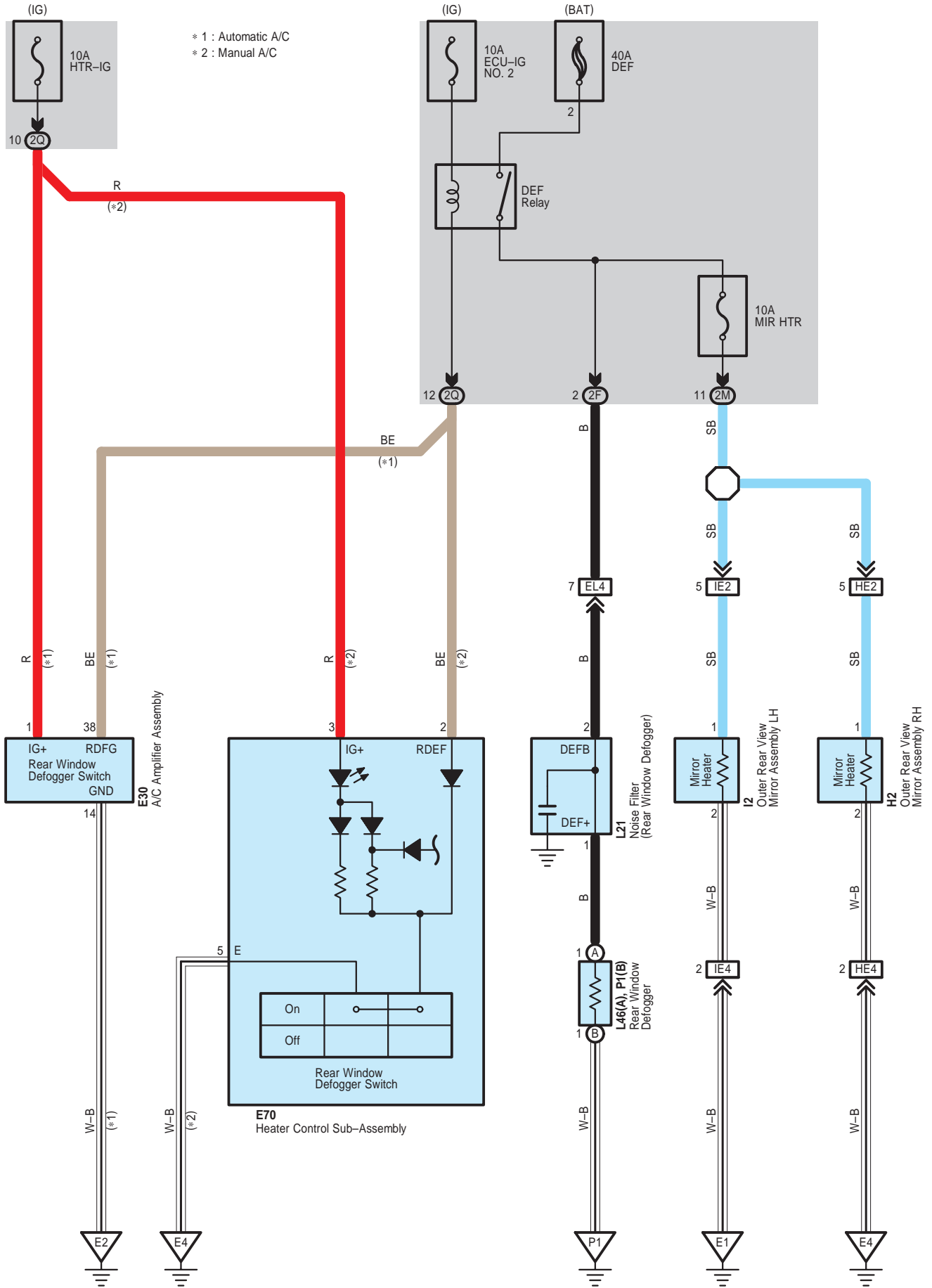

Mirror Heater <Except TMC Made> , Rear Window Defogger <Except TMC Made>

E 30  
White

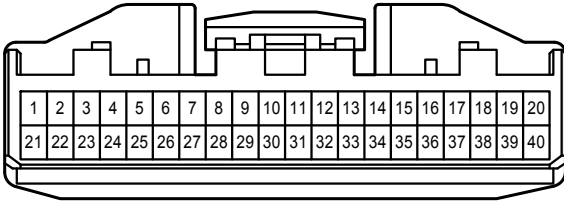

E 70  
Gray

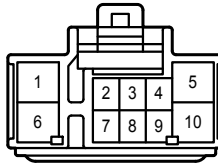

H 2  
White

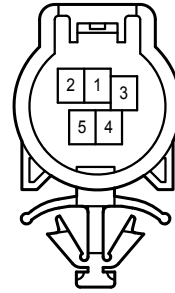

I 2  
White

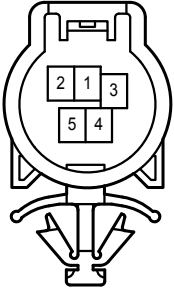

L 21  
Gray

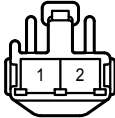

L 46  
Black



P 1  
Black



2F  
White

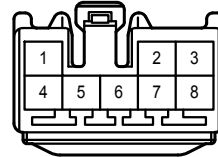

2M  
White

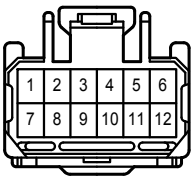

2Q  
White

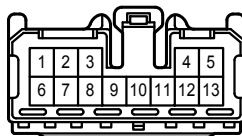

EL4  
Gray

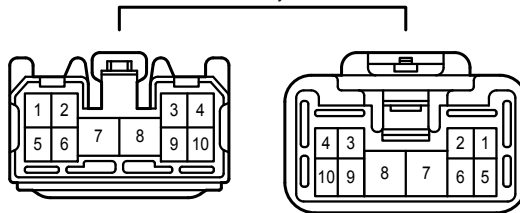

HE2  
White

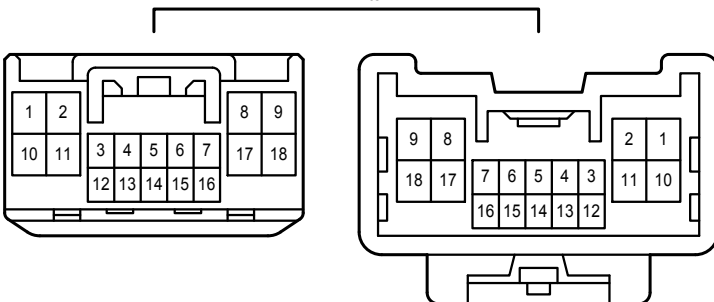

HE4  
White

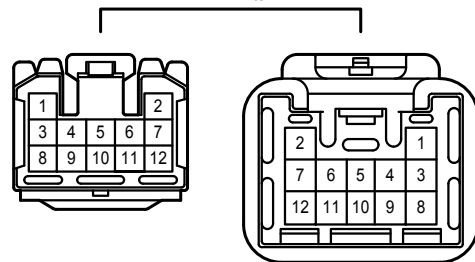

IE2  
White

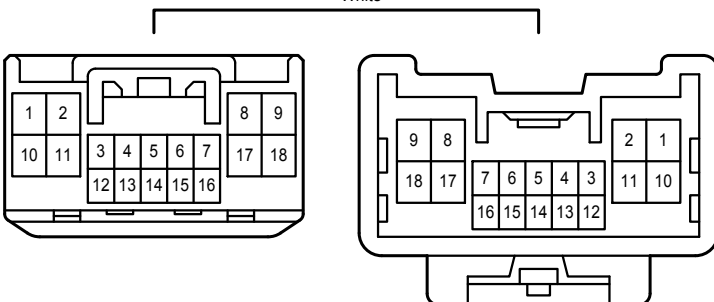

IE4  
White

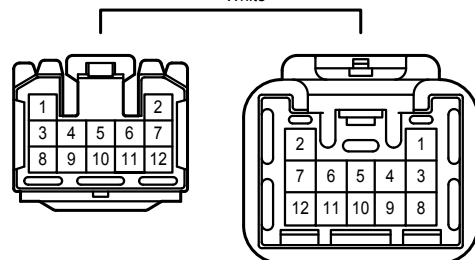

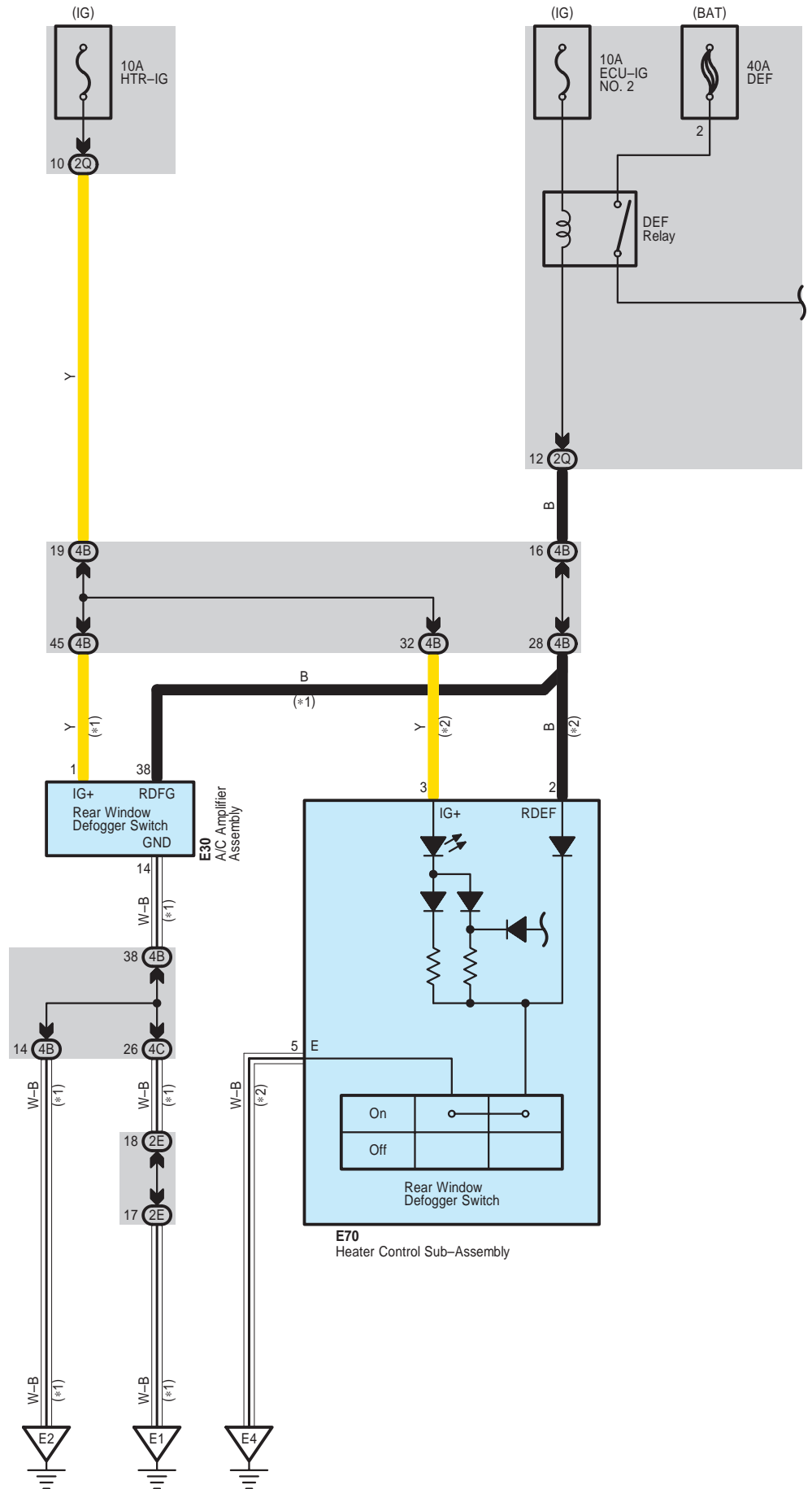

Mirror Heater <TMC Made> , Rear Window Defogger <TMC Made>

- \* 1 : Automatic A/C
- \* 2 : Manual A/C

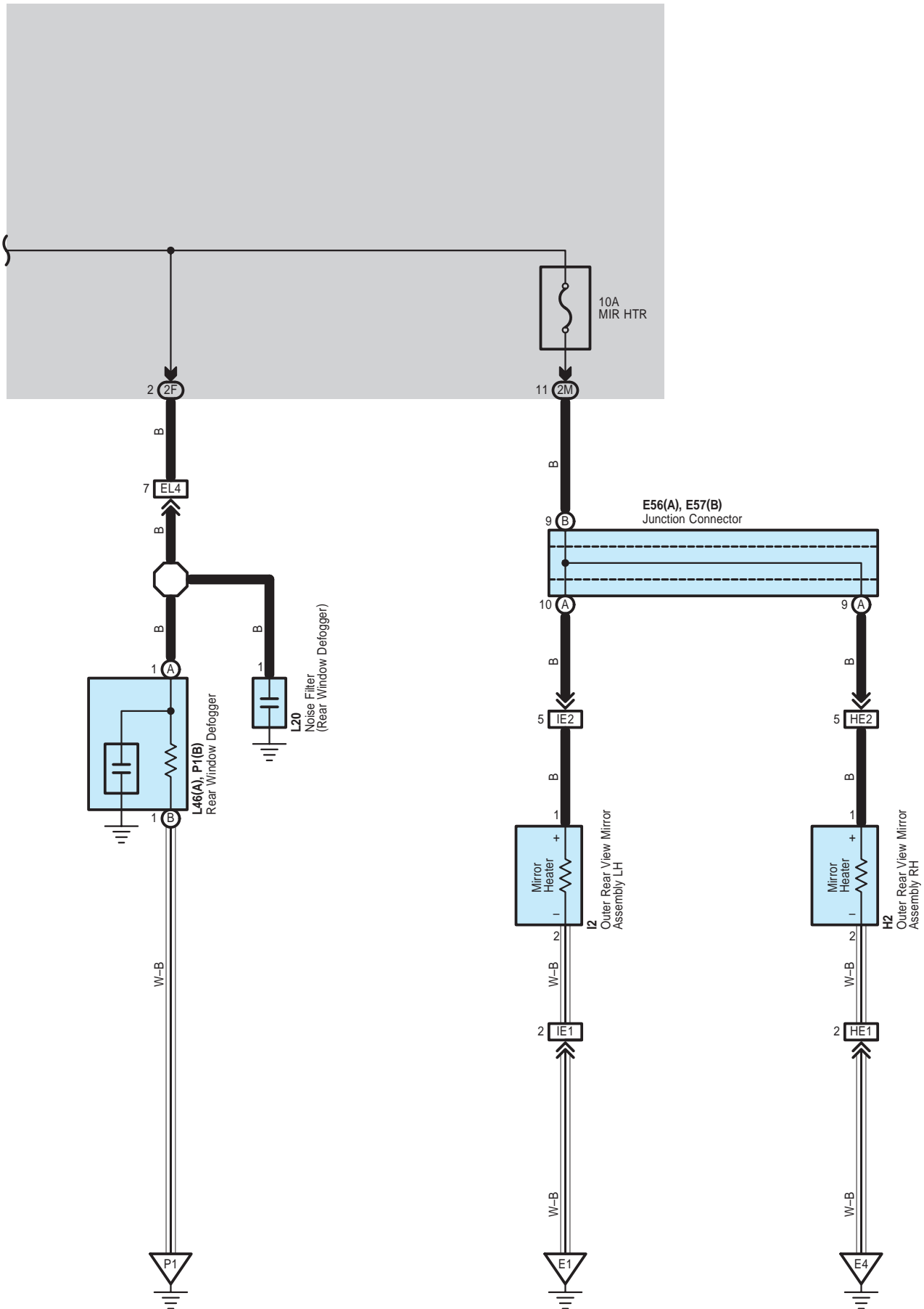

Mirror Heater <TMC Made> , Rear Window Defogger <TMC Made>

E 30  
White

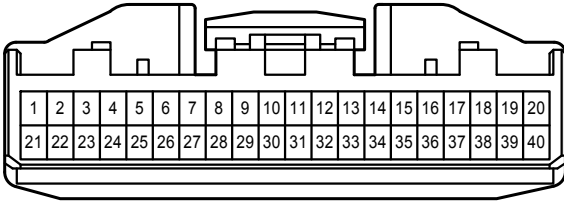

E 56  
White

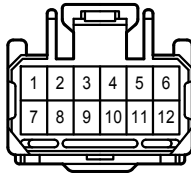

E 57  
White

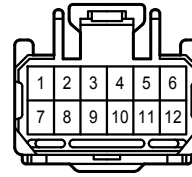

E 70  
Gray

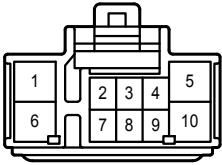

H 2  
White

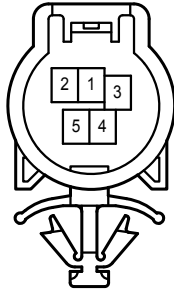

I 2  
White

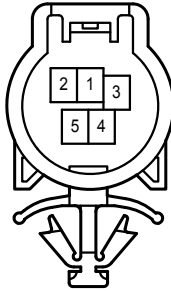

L 20  
White

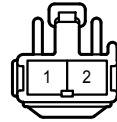

L 46  
Black



P 1  
Black



2E  
White

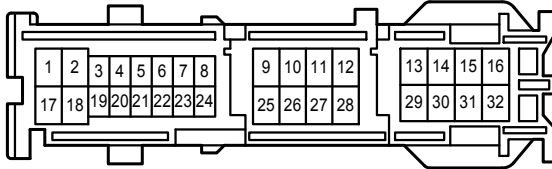

2F  
White

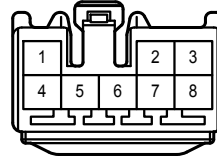

2M  
White

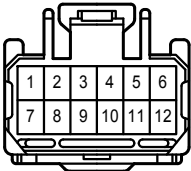

2Q  
White

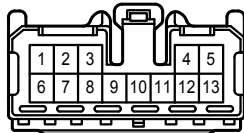

4B  
White

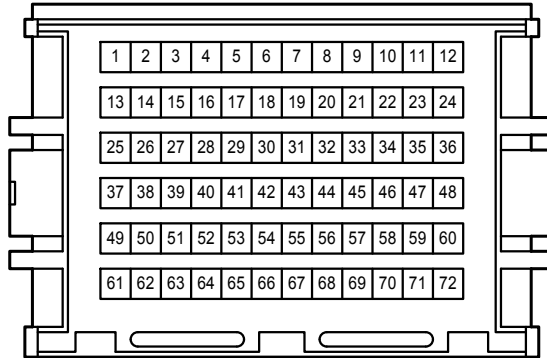

4C  
White

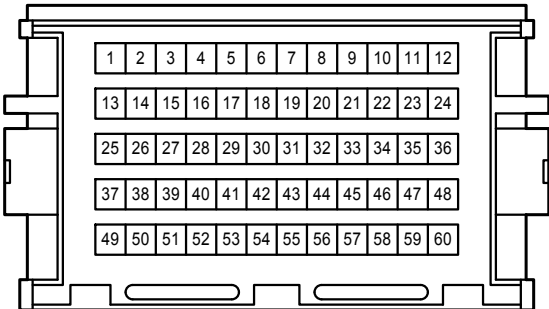

EL4  
Gray

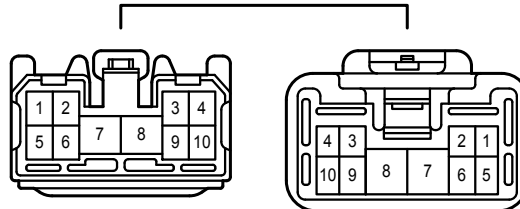

Mirror Heater <TMC Made> , Rear Window Defogger <TMC Made>

HE1  
Blue

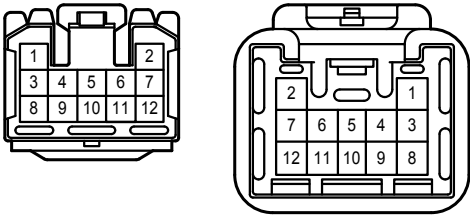

HE2  
White

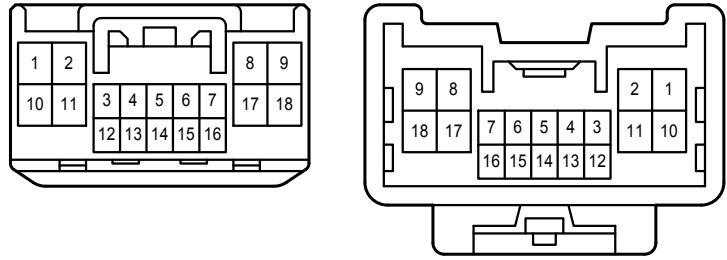

IE1  
Blue

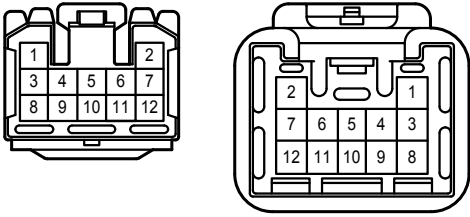

IE2  
White

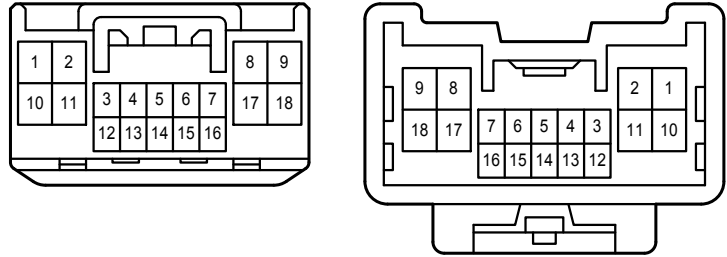



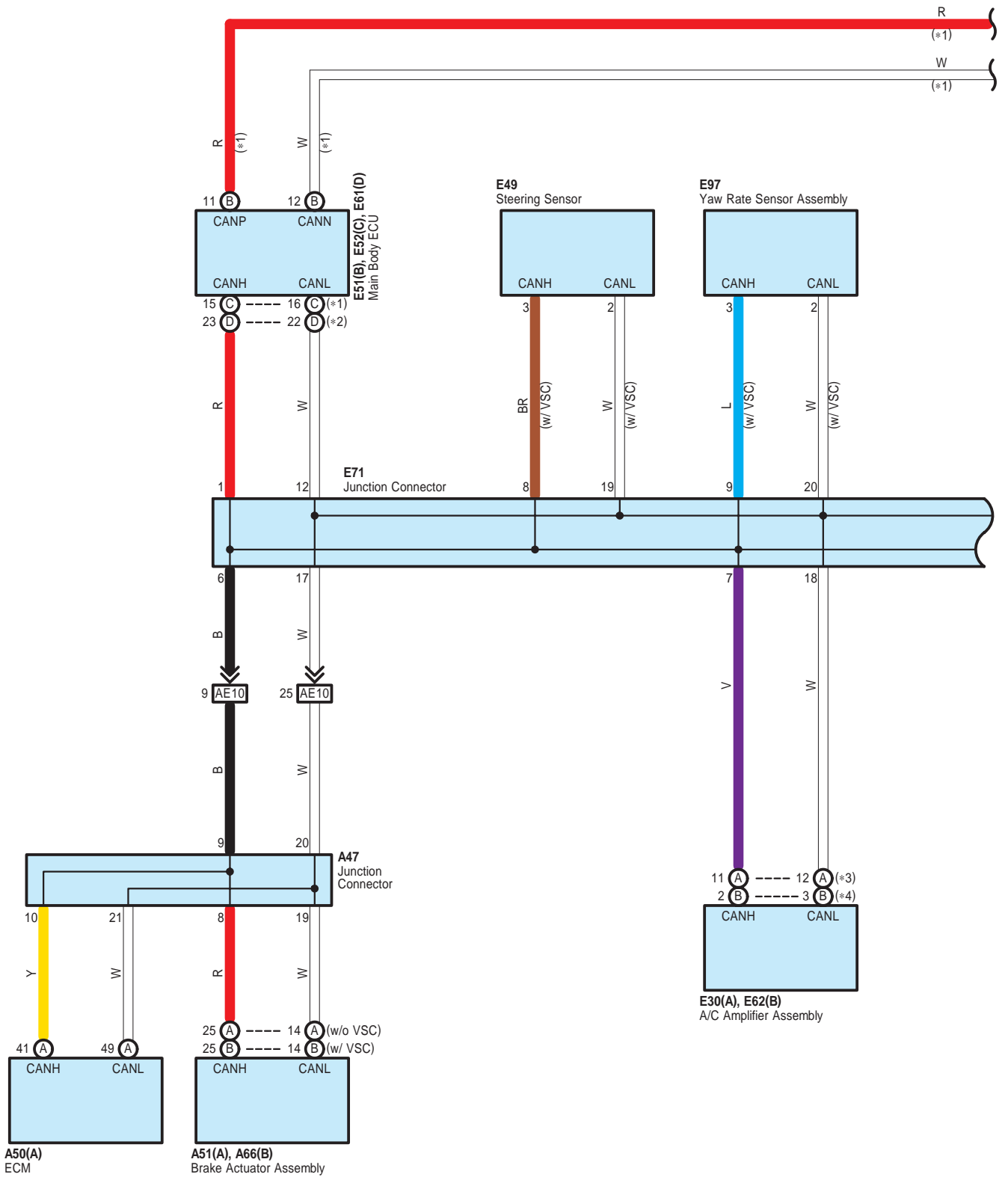

Multiplex Communication System <CAN , Except TMC Made>

- \* 1 : w/ Smart Key System
- \* 2 : w/o Smart Key System
- \* 3 : Automatic A/C
- \* 4 : Manual A/C

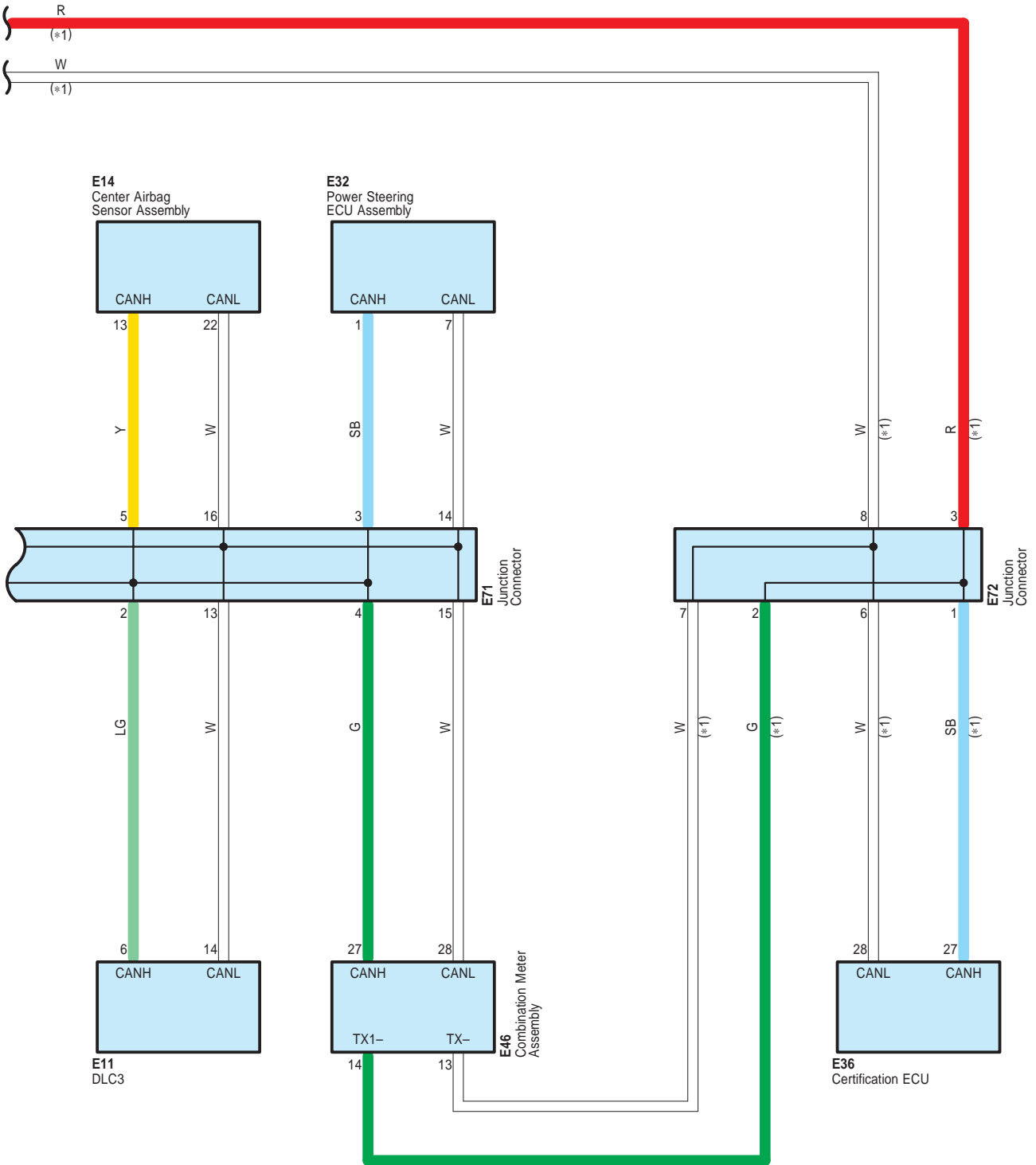

Multiplex Communication System <CAN , Except TMC Made>

A 47  
White

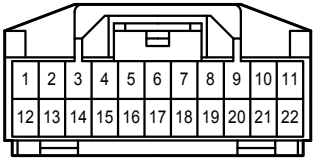

A 50  
Black

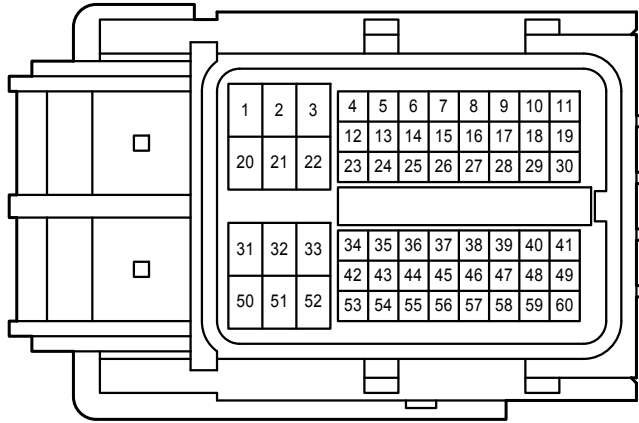

A 51  
Gray

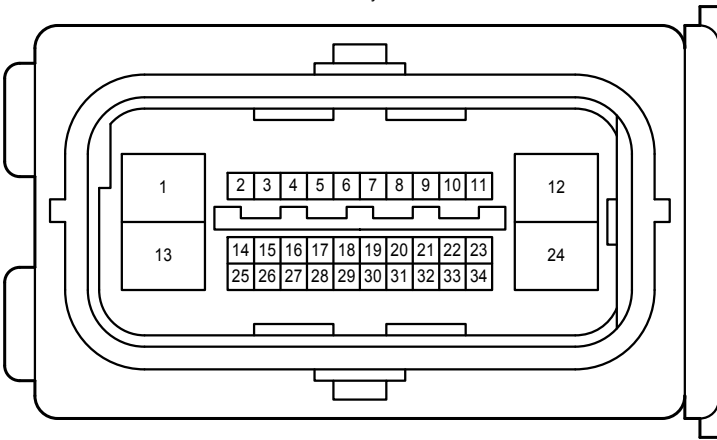

A 66  
Black

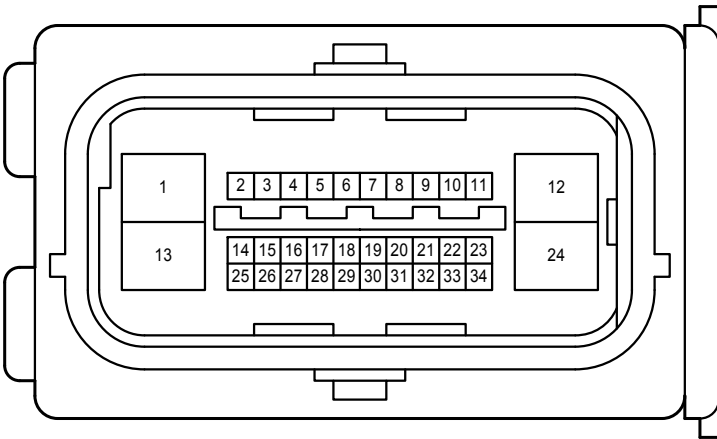

E 11  
White

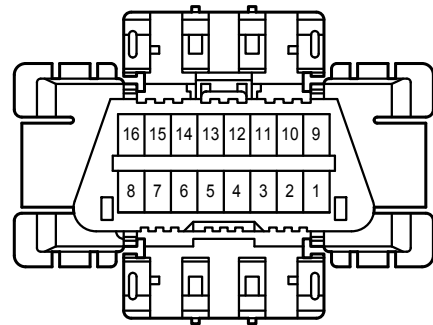

Multiplex Communication System <CAN , Except TMC Made>

E 14  
Yellow

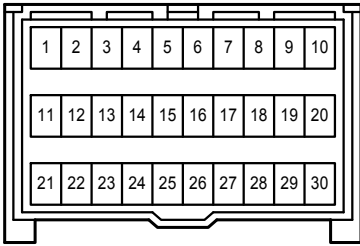

E 30  
White

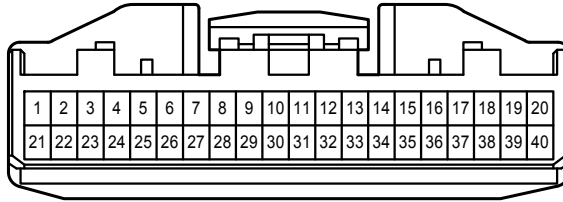

E 32  
White

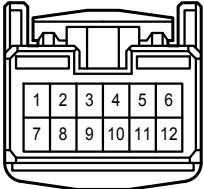

E 36  
White

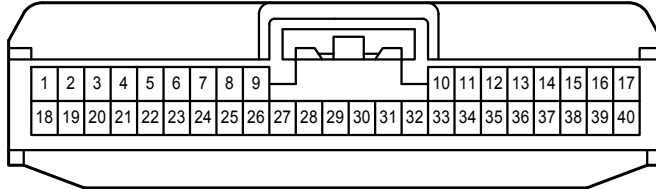

E 46  
White

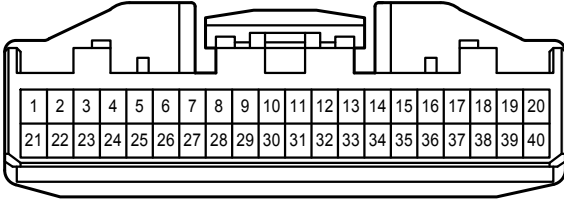

E 49  
Black

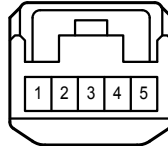

E 51  
White

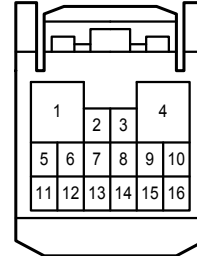

E 52  
White

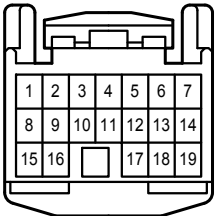

E 61  
White

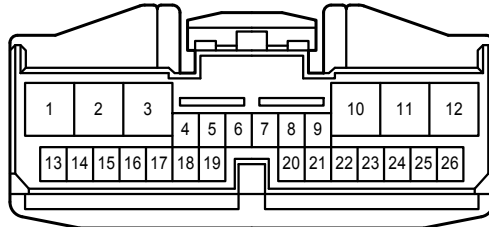

E 62  
White

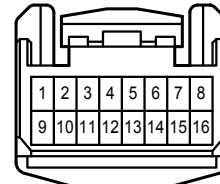

E 71  
White

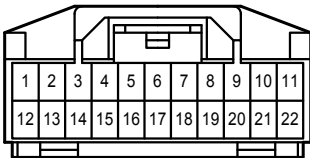

E 72  
Black

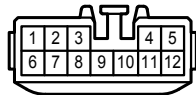

E 97  
Black

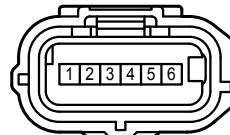

AE10  
Gray

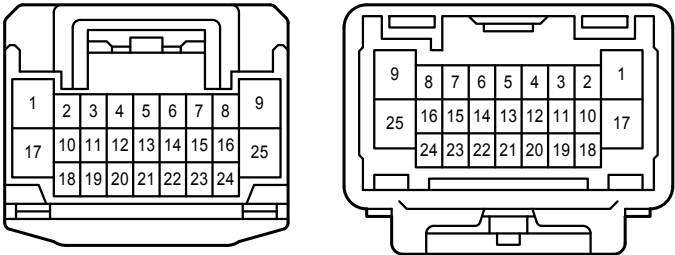

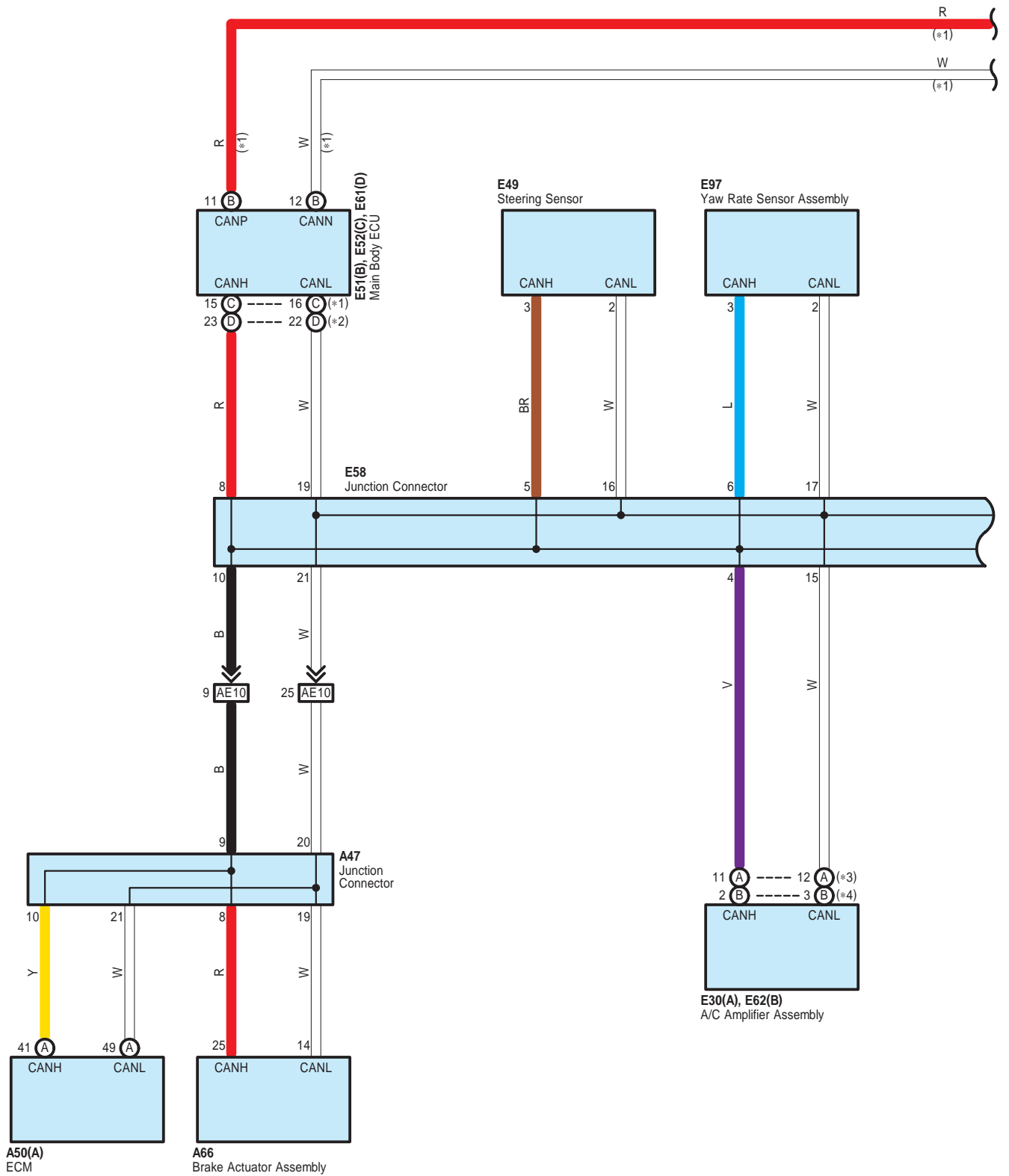

- \* 1 : w/ Smart Key System
- \* 2 : w/o Smart Key System
- \* 3 : Automatic A/C
- \* 4 : Manual A/C

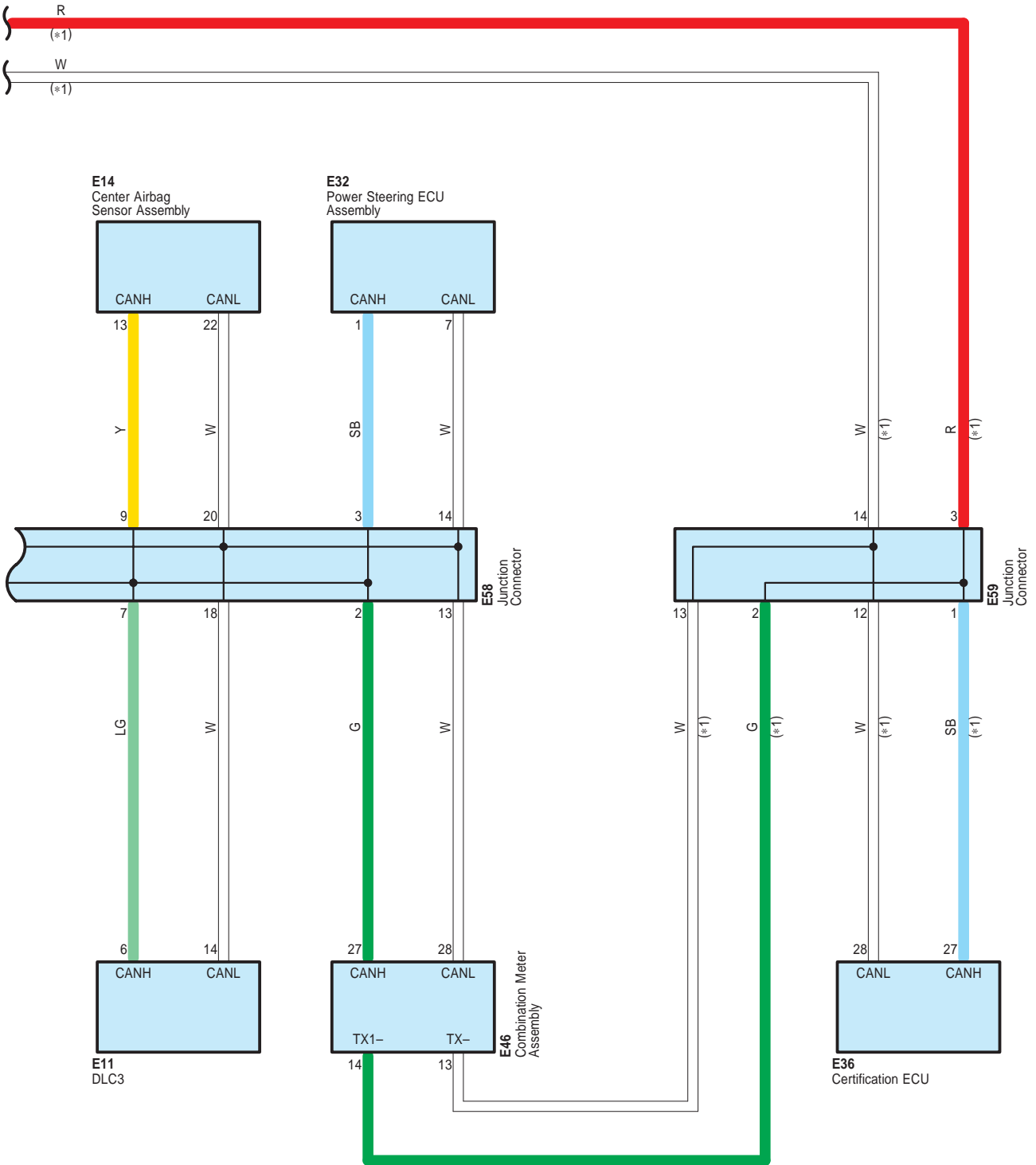

A 47  
White

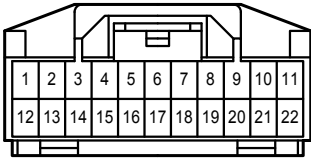

A 50  
Black

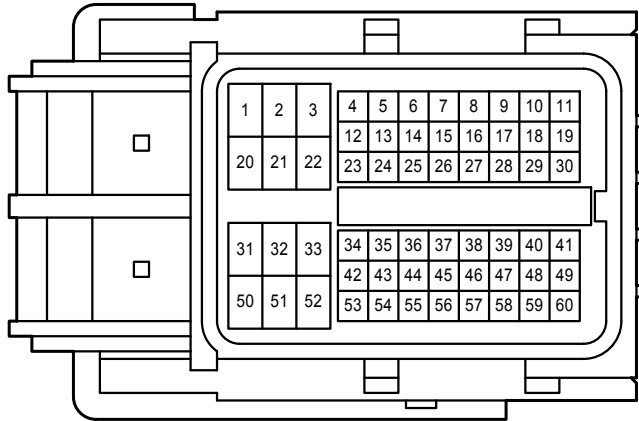

A 66  
Black

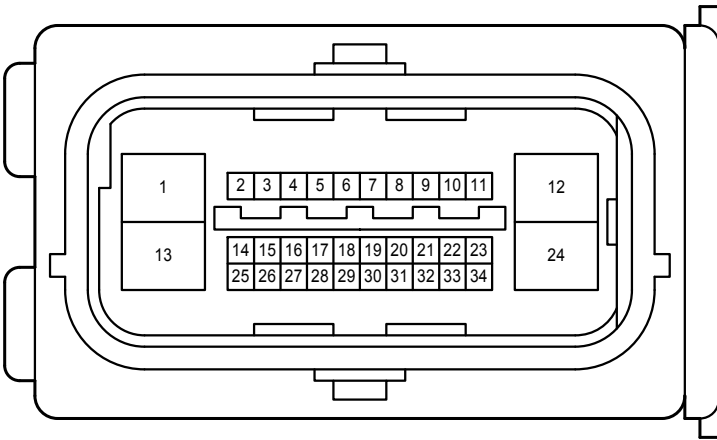

E 11  
White

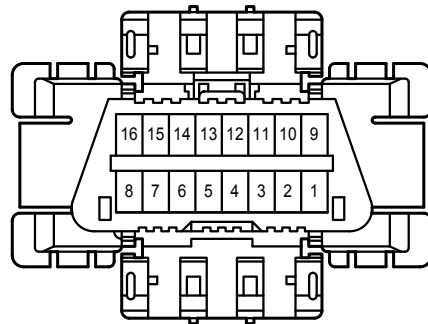

E 14  
Yellow

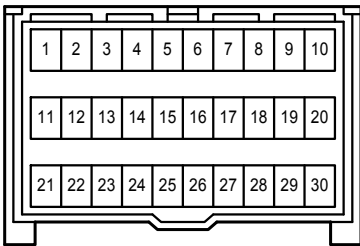

E 30  
White

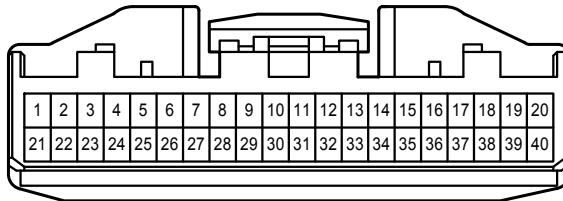

E 32  
White

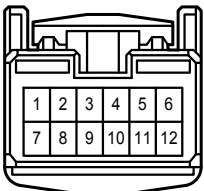

E 36  
White

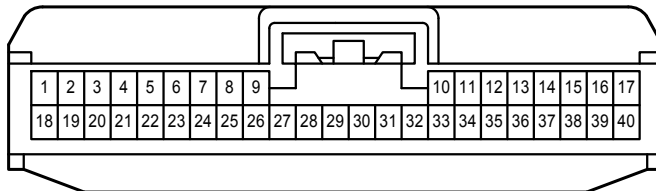



E 46  
White

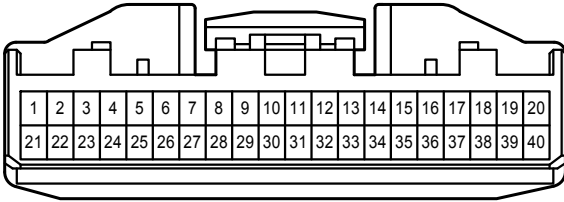

E 49  
Black

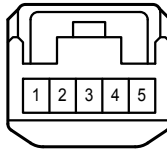

E 51  
White

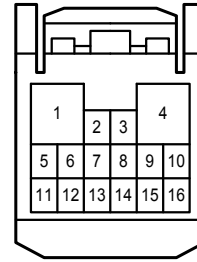

E 52  
White

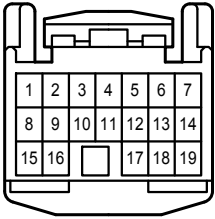

E 58  
Gray

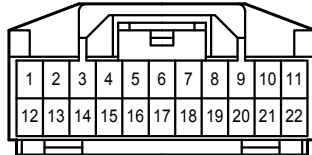

E 59  
White

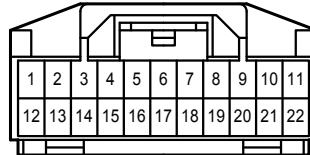

E 61  
White

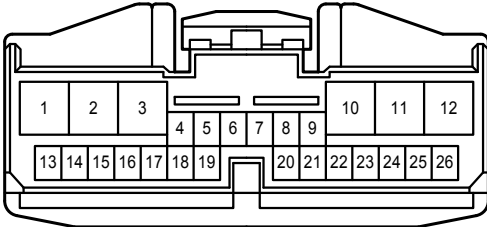

E 62  
White

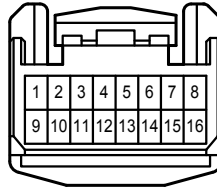

E 97  
Black

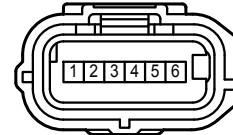

AE10  
Gray

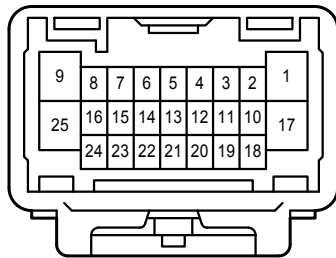
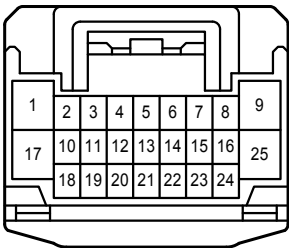

Power Outlet <TMC Made>

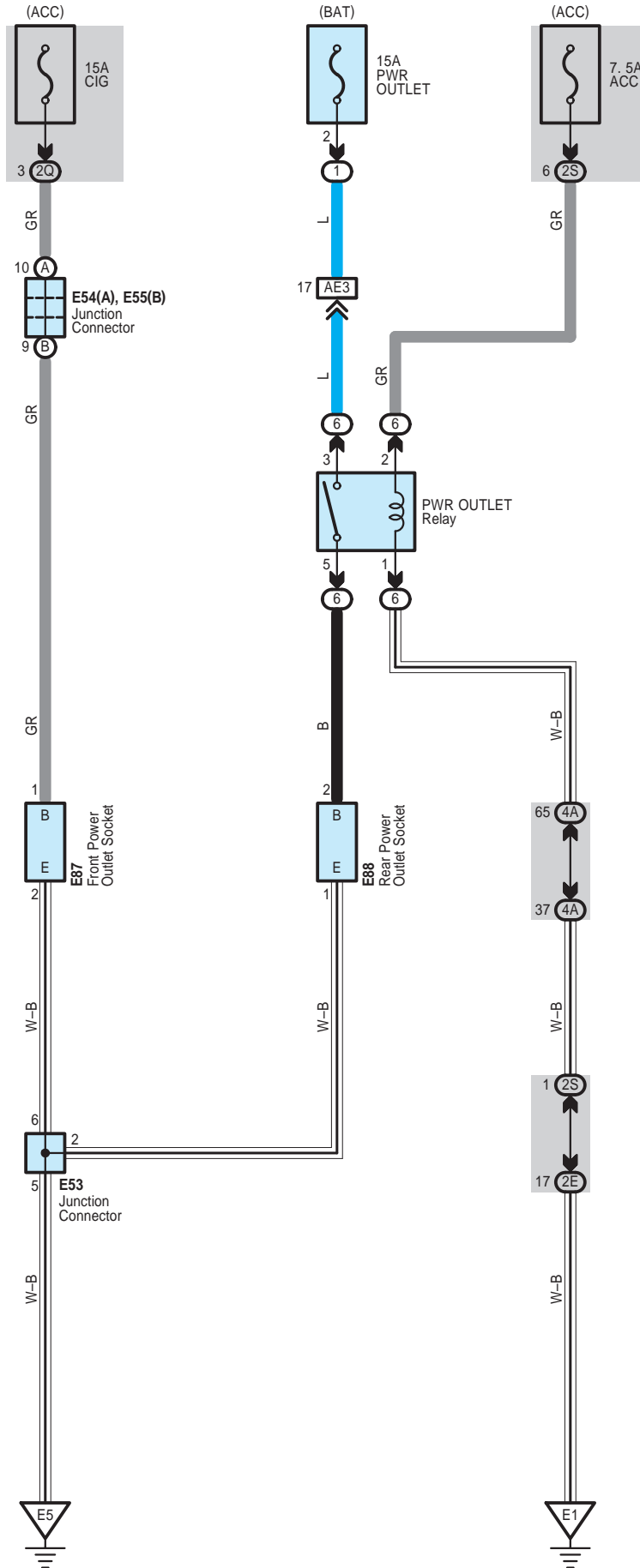

Power Outlet <TMC Made>

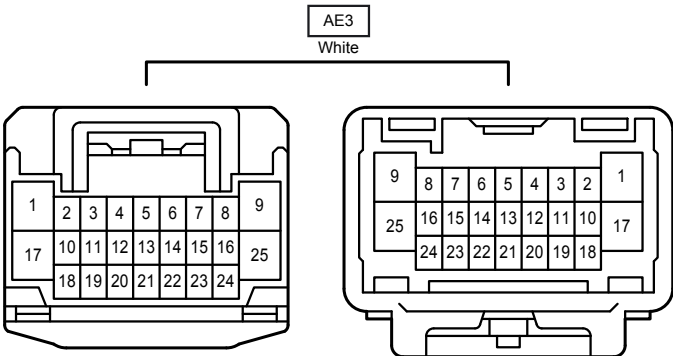
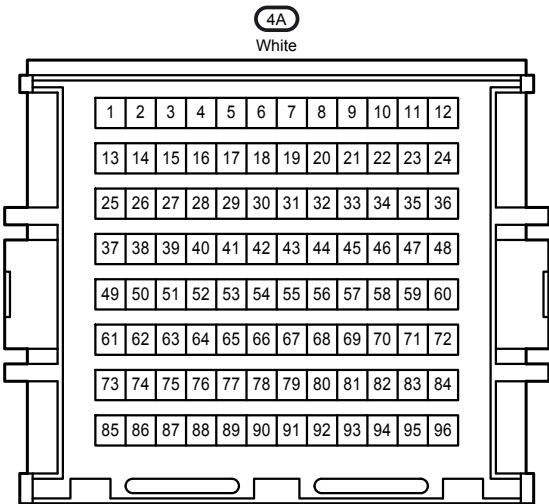
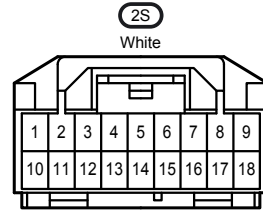
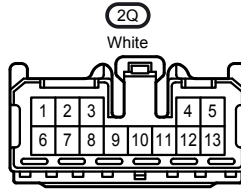
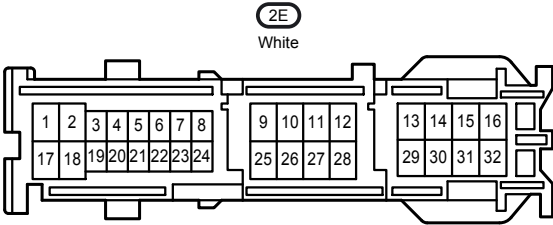
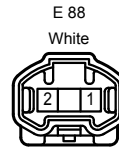
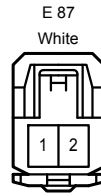
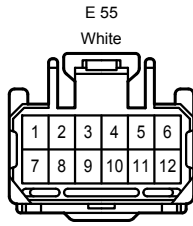
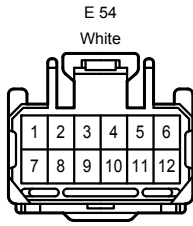
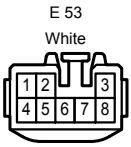

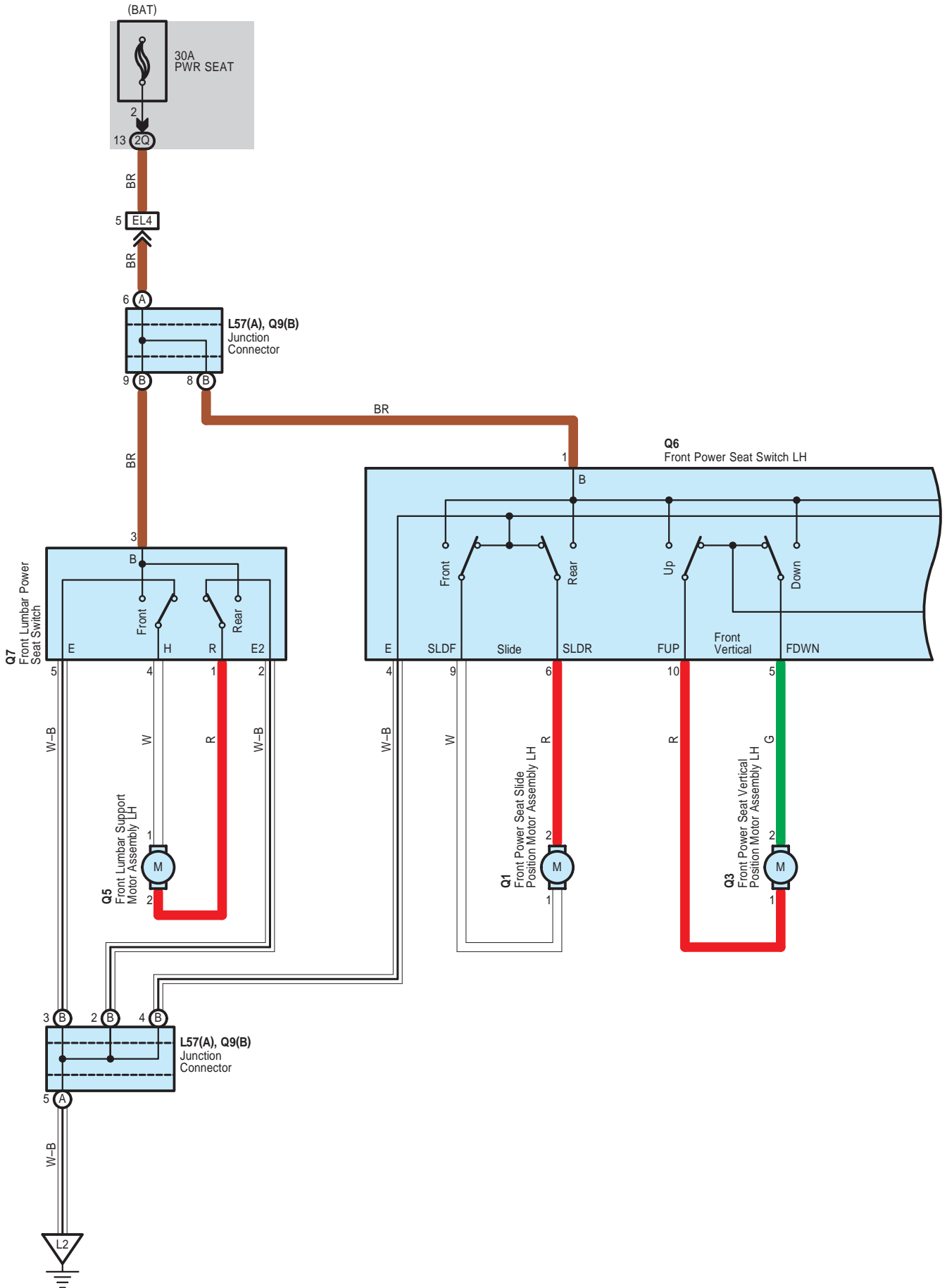

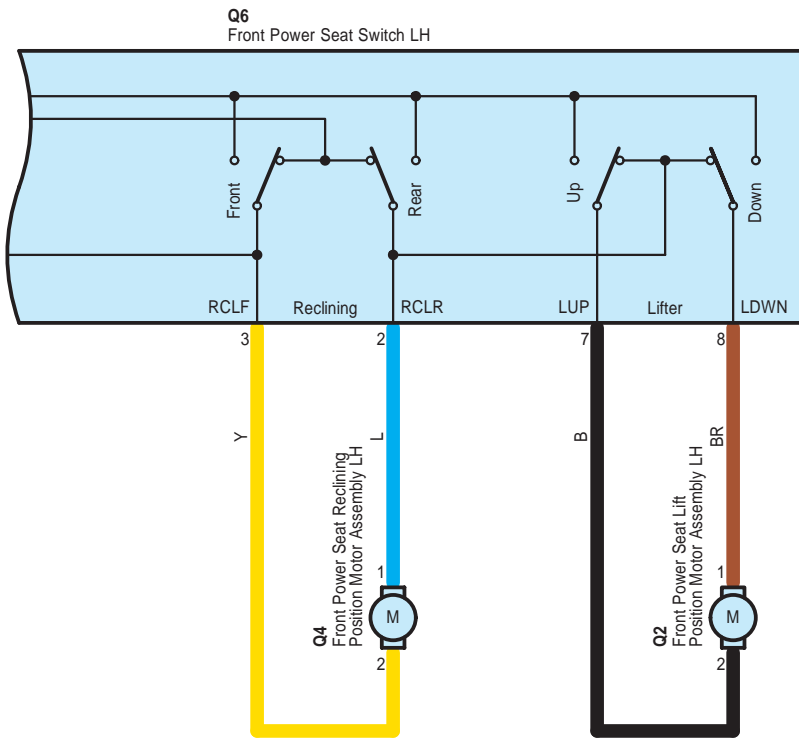

Power Seat <Except TMC Made>

L 57  
White

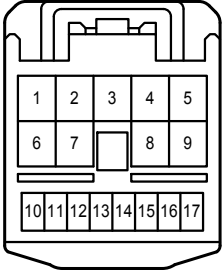

Q 1  
Black



Q 2  
Black

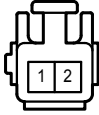

Q 3  
Black

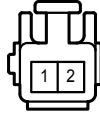

Q 4  
Black



Q 5  
White

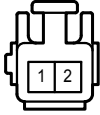

Q 6  
White

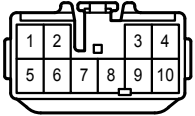

Q 7  
White



Q 9  
White

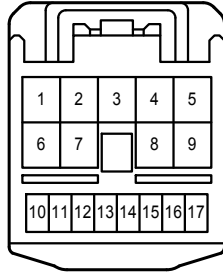

2Q  
White

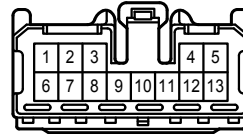

EL4  
Gray

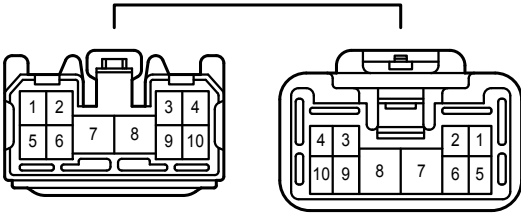

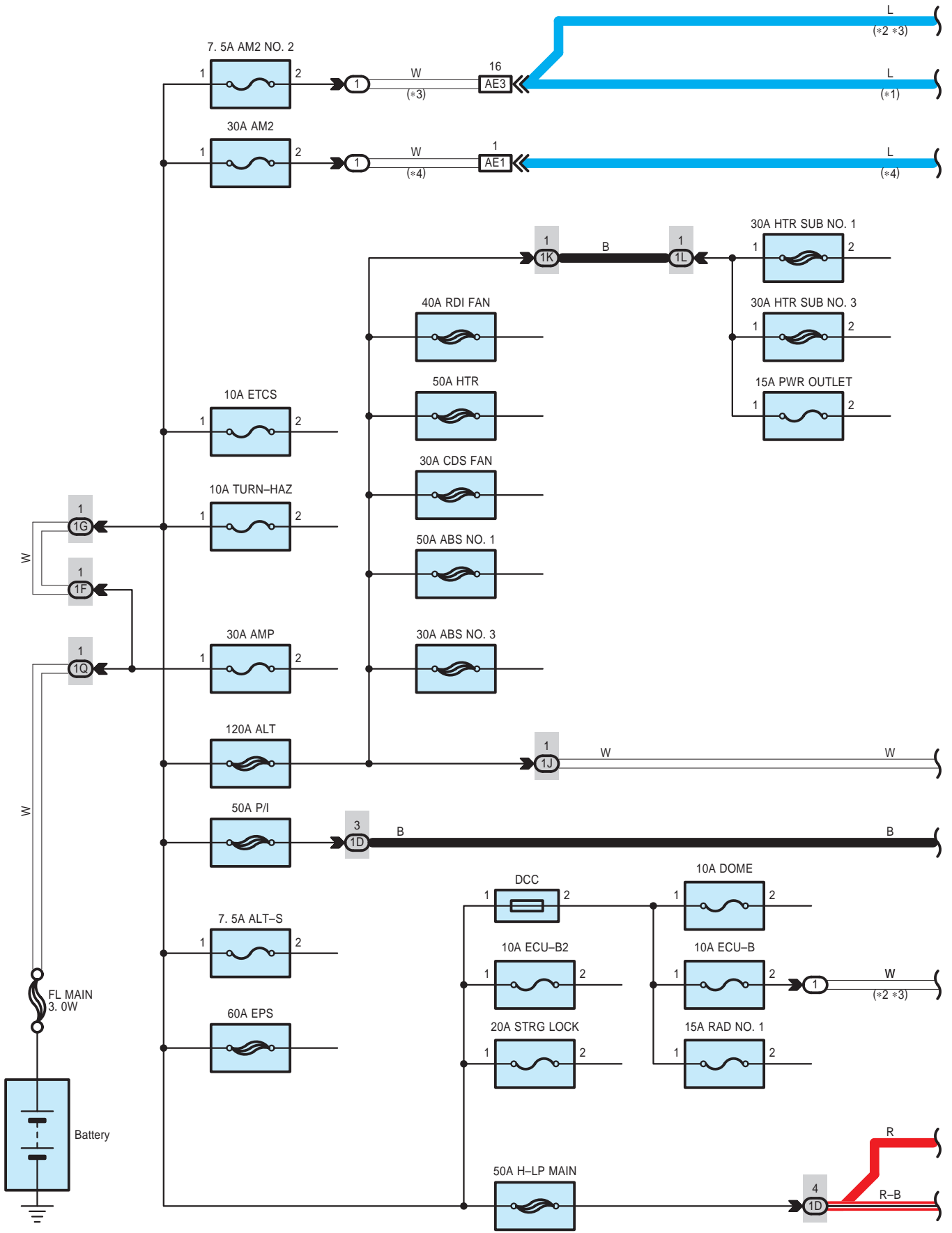

Power Source <Except TMC Made>

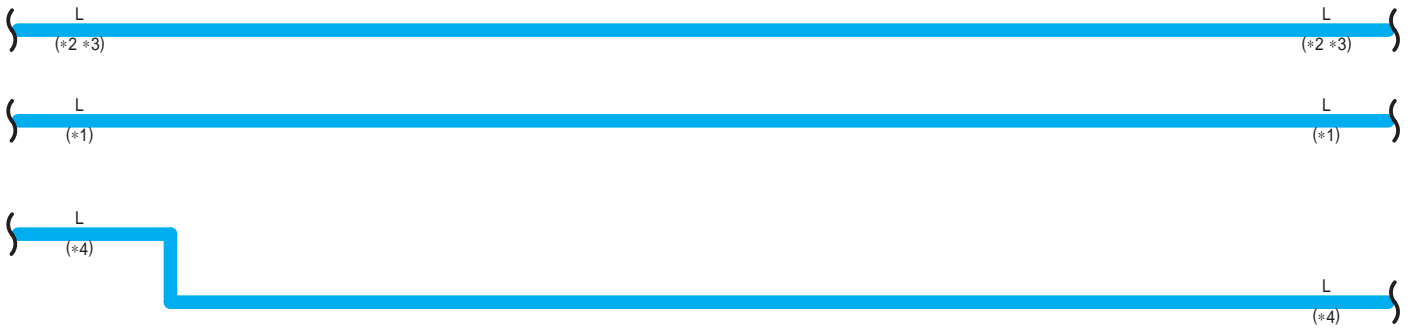

- \* 1 : w/ Smart Key System
- \* 2 : w/o Smart Key System
- \* 3 : 2ZR-FE
- \* 4 : 2AZ-FE

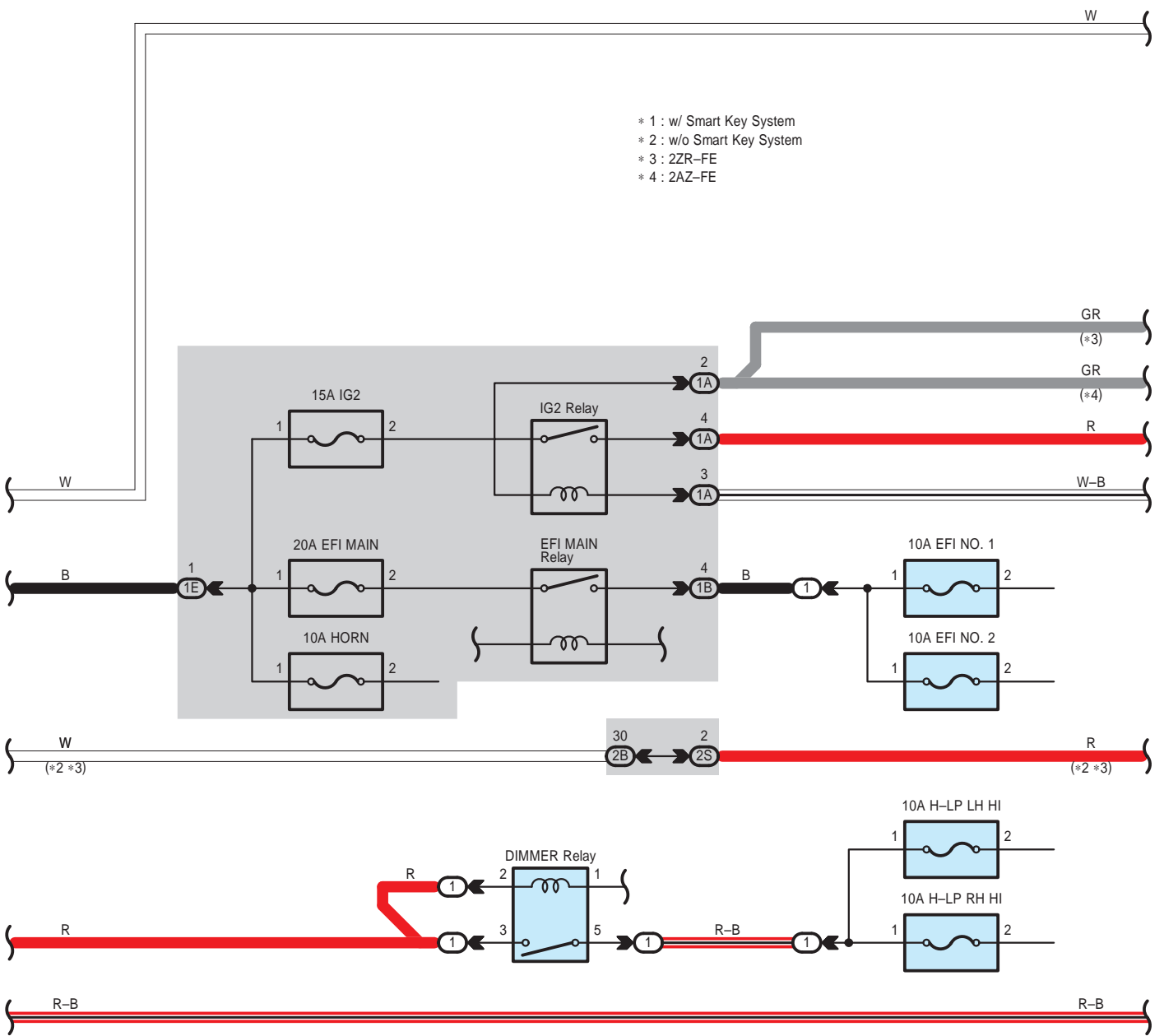



Power Source <Except TMC Made>

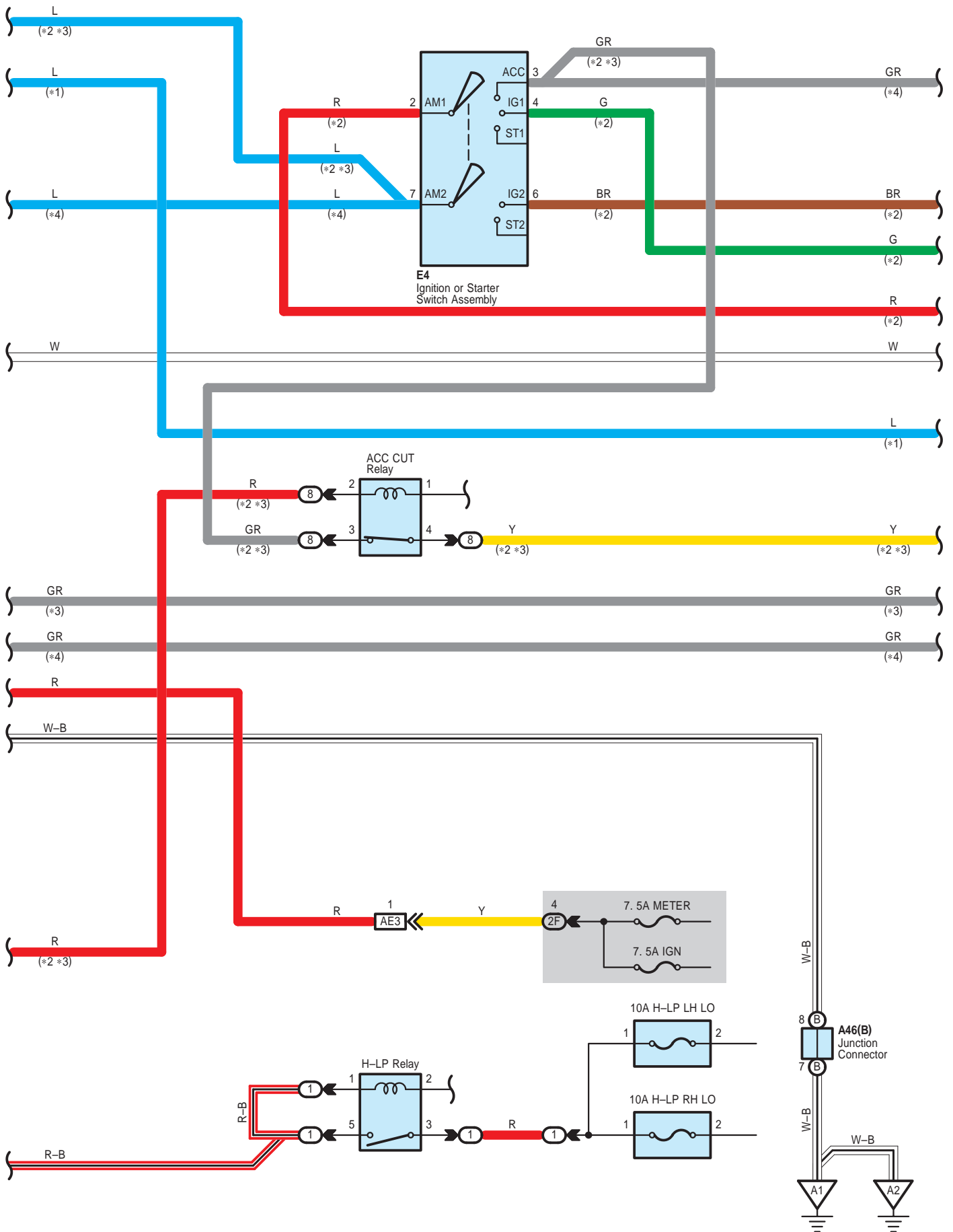

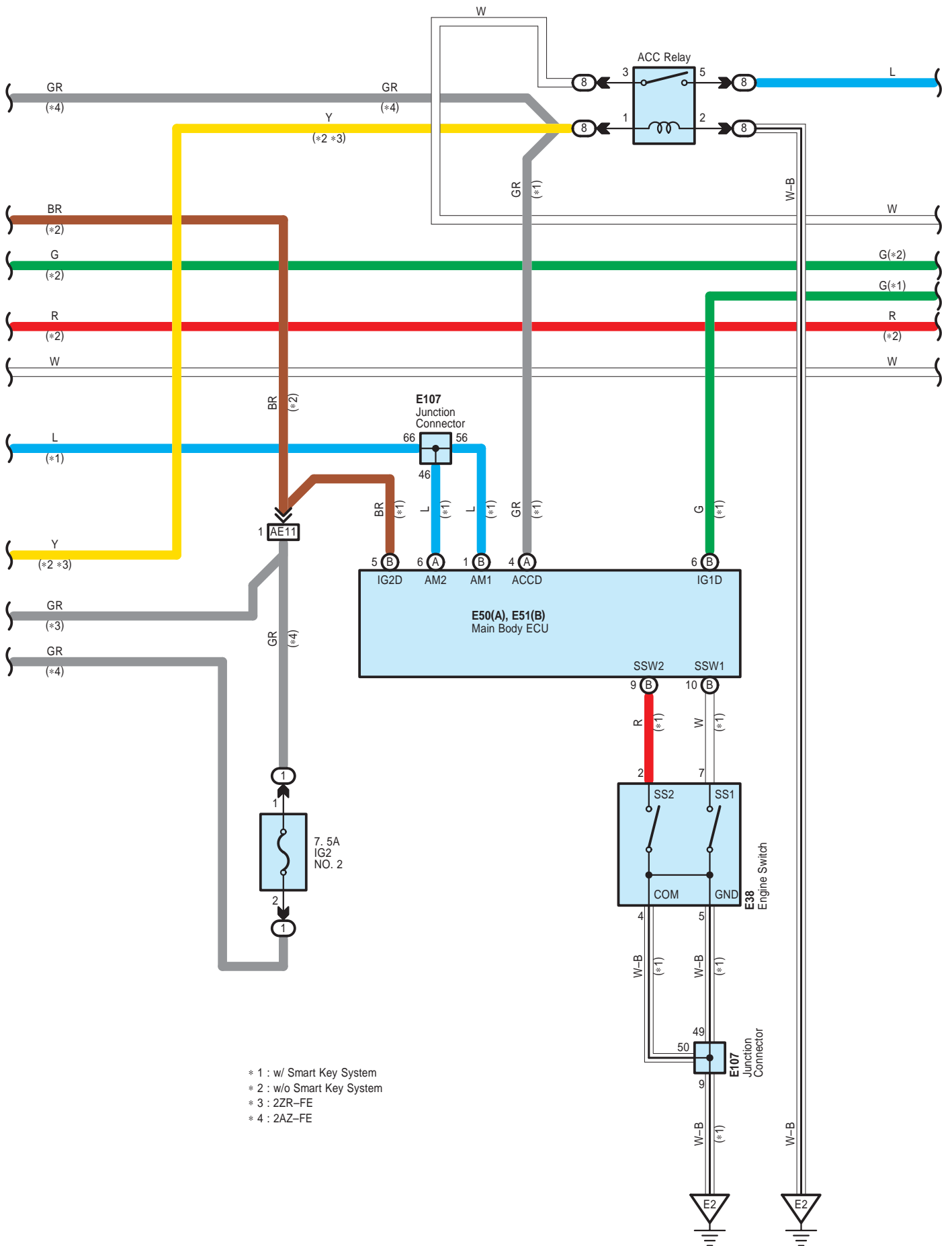

- \* 1 : w/ Smart Key System
- \* 2 : w/o Smart Key System
- \* 3 : 2ZR-FE
- \* 4 : 2AZ-FE

Power Source <Except TMC Made>

\* 1 : w/ Smart Key System  
 \* 2 : w/o Smart Key System

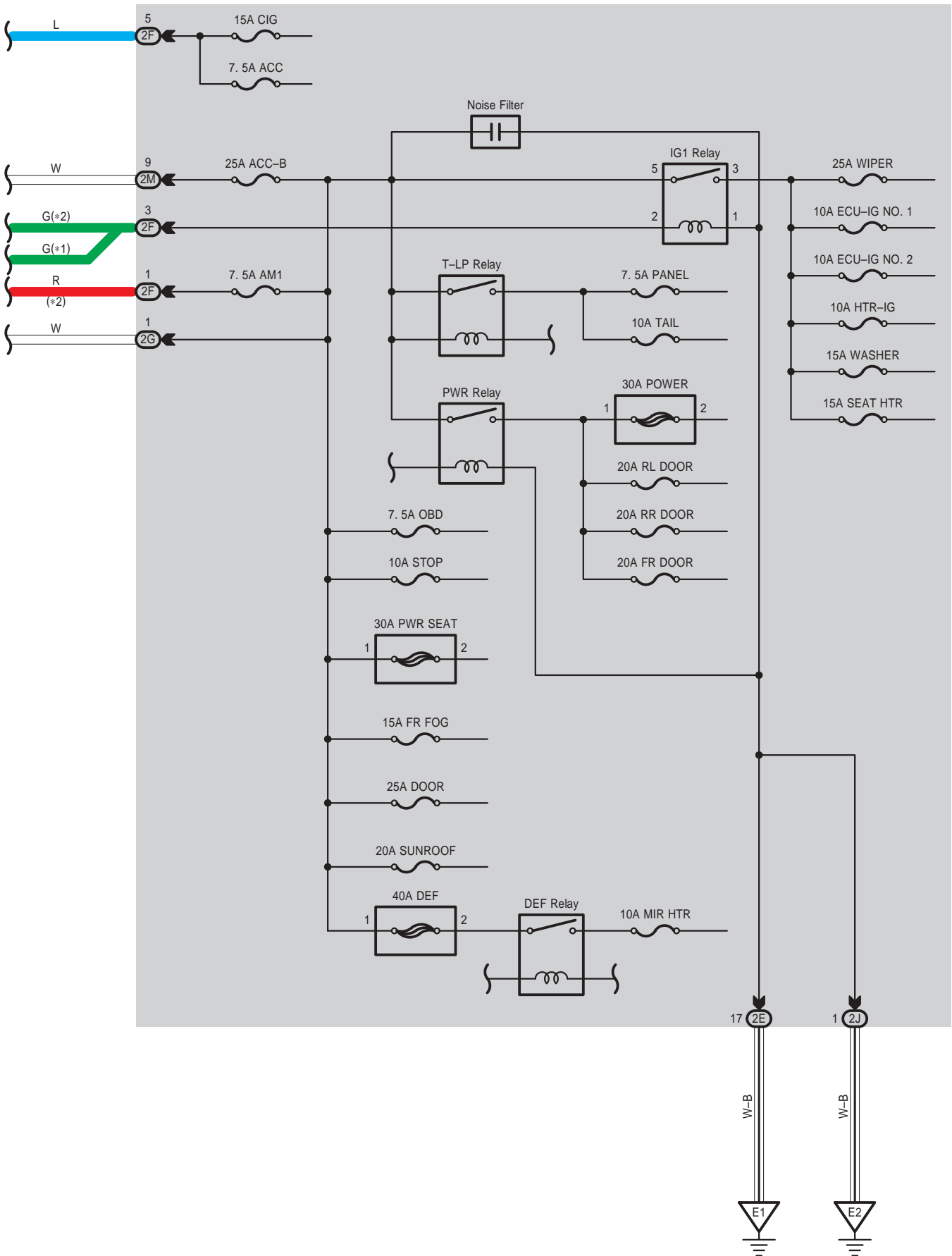

Power Source <Except TMC Made>

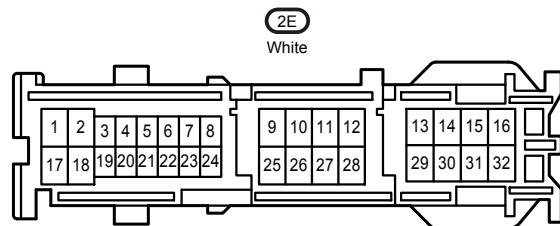
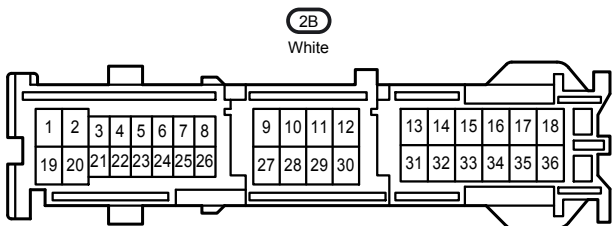
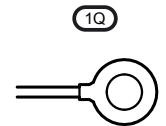
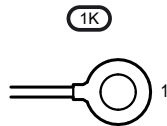
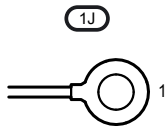
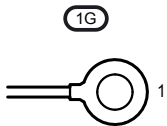
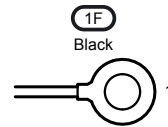
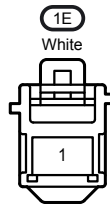
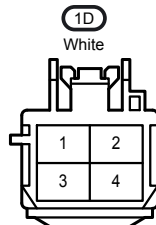
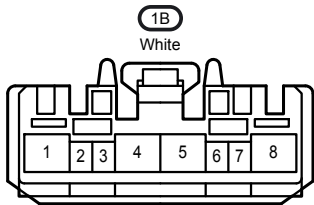
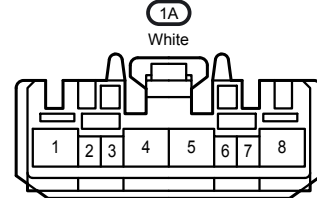
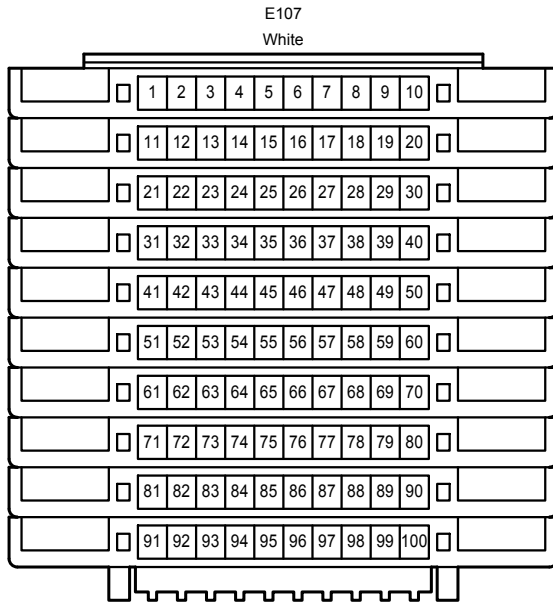
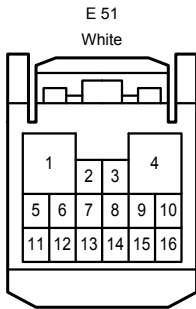
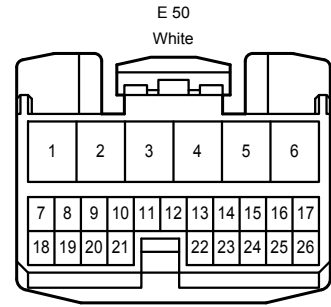
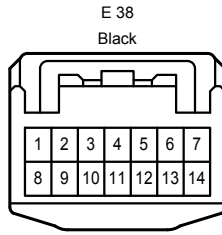
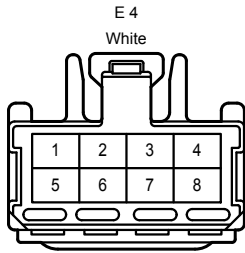
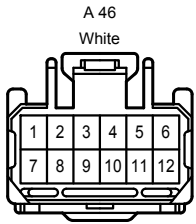

Power Source <Except TMC Made>

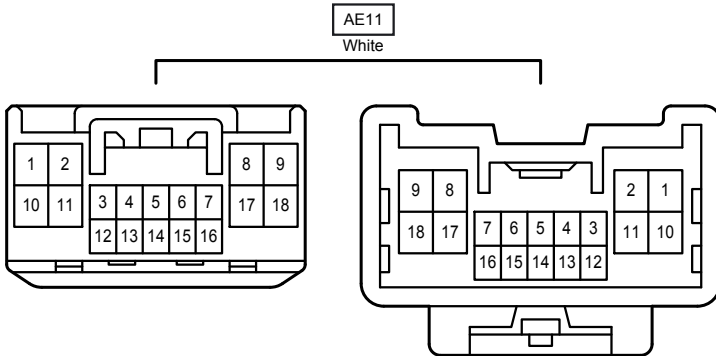
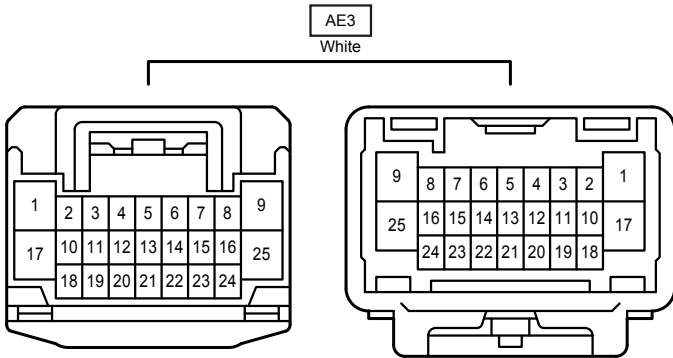
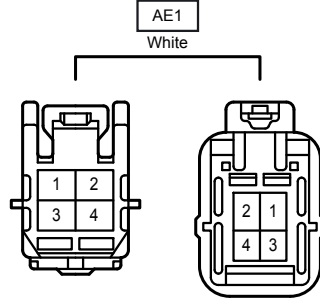
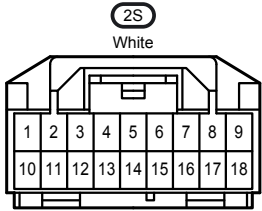
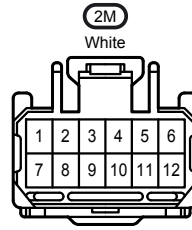
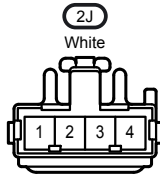
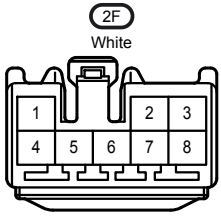

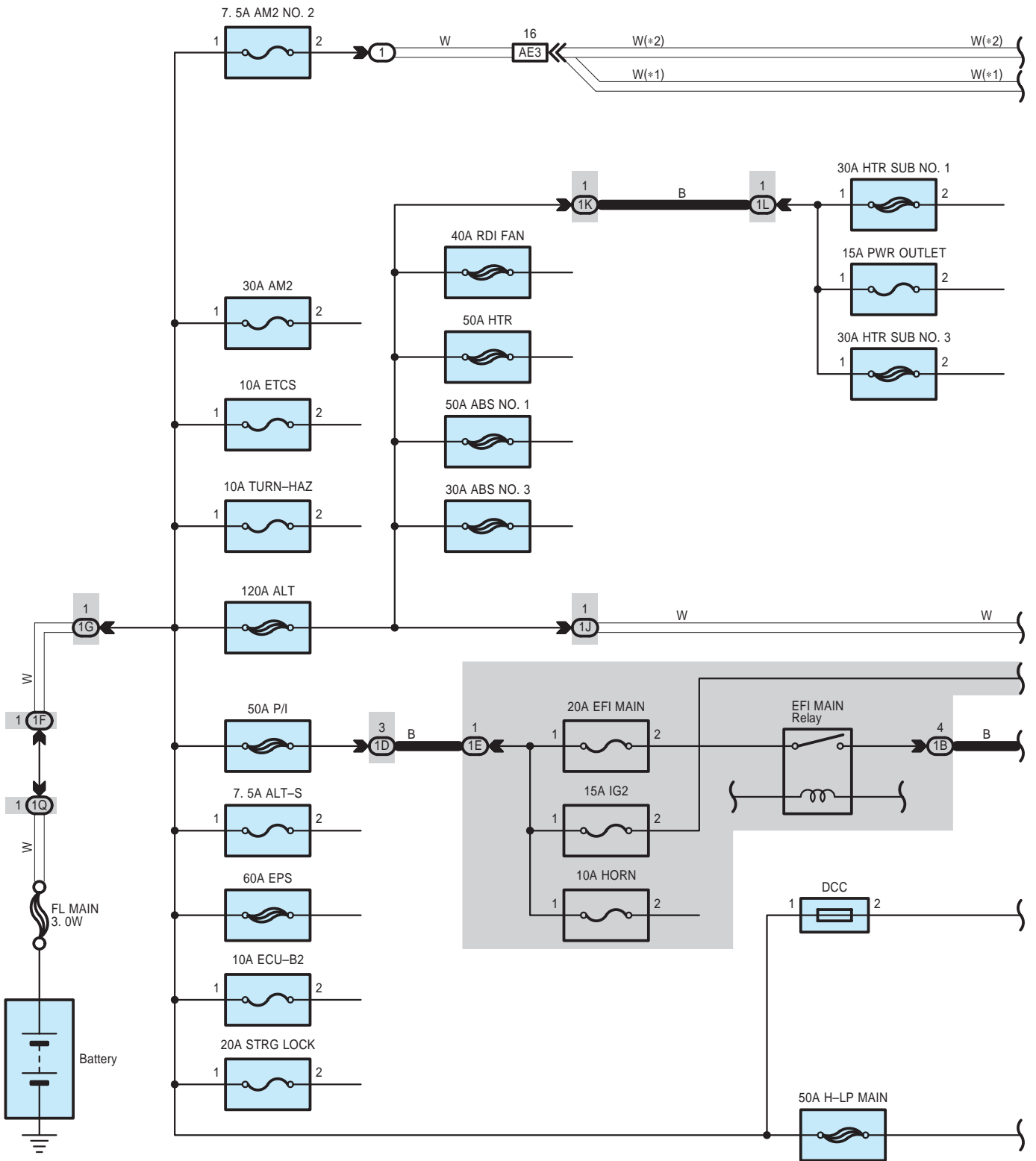

\* 1 : w/ Smart Key System  
 \* 2 : w/o Smart Key System

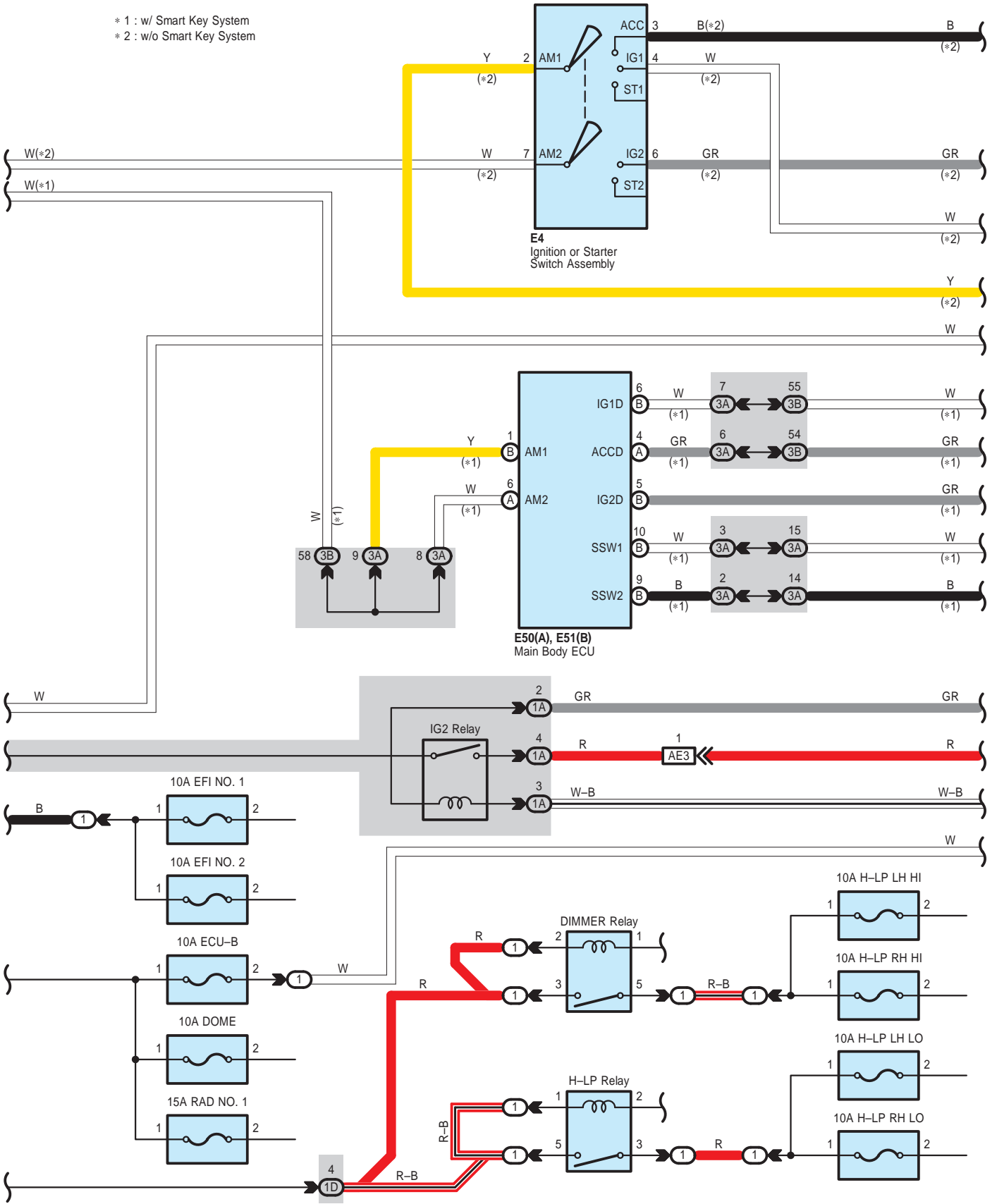

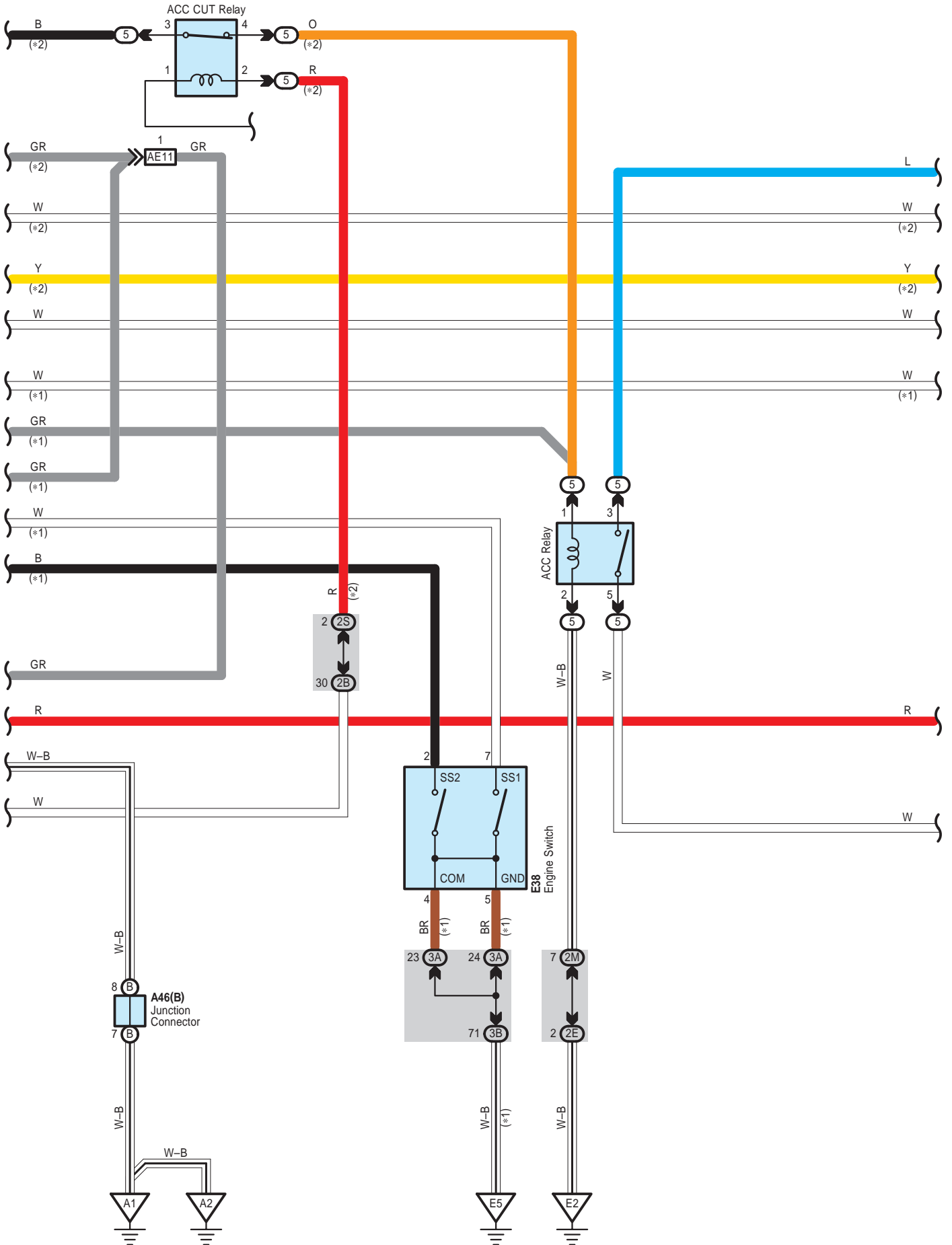



Power Source <TMC Made>

- \* 1 : w/ Smart Key System
- \* 2 : w/o Smart Key System

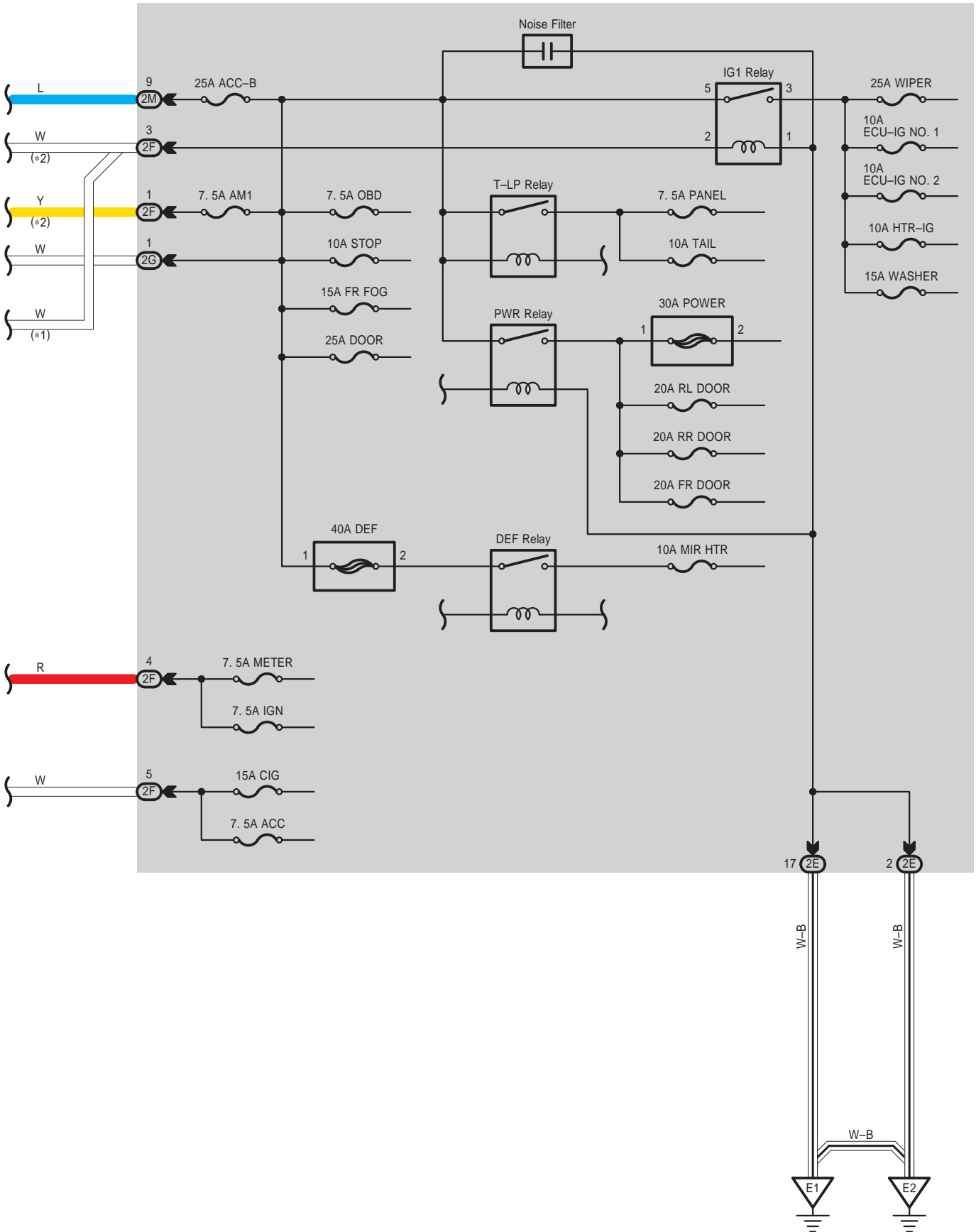

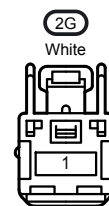
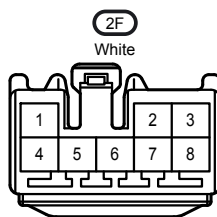
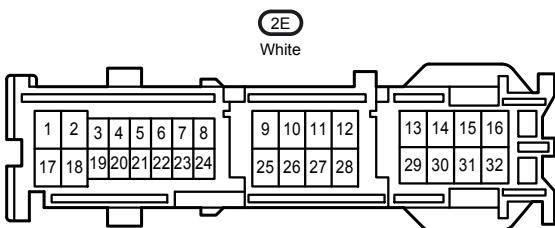
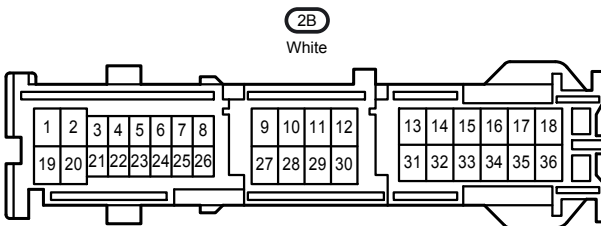
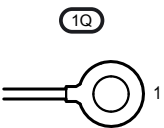
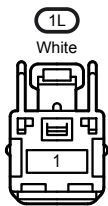
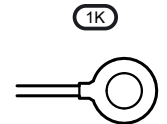
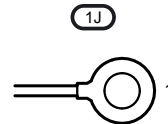
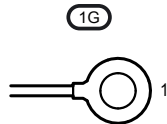
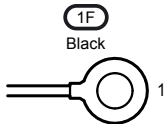
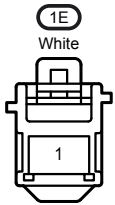
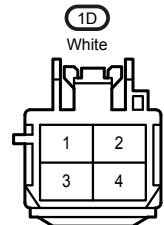
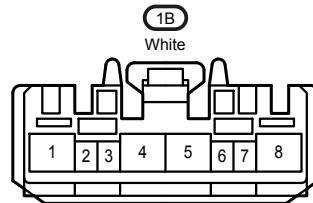
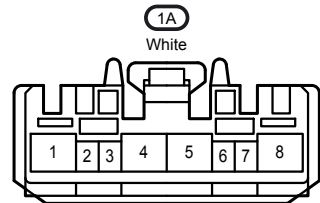
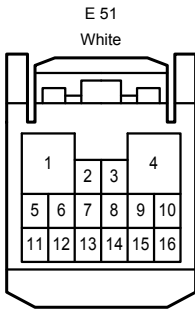
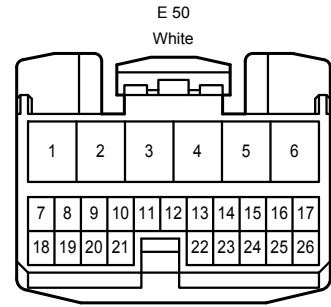
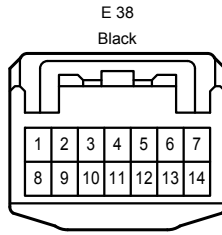
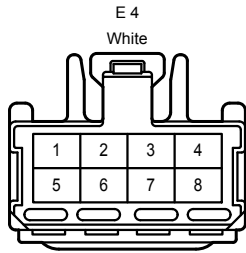
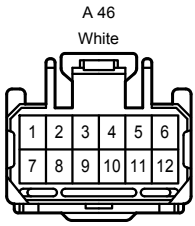

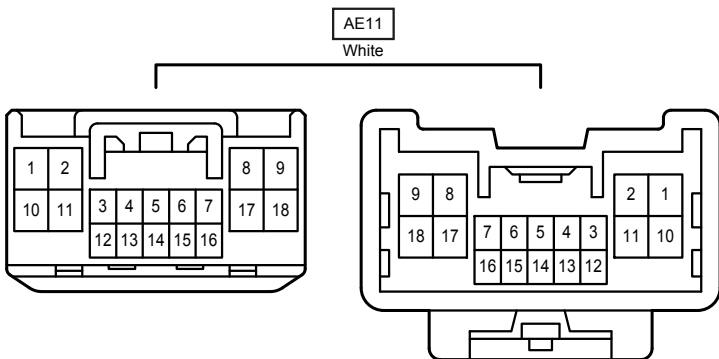
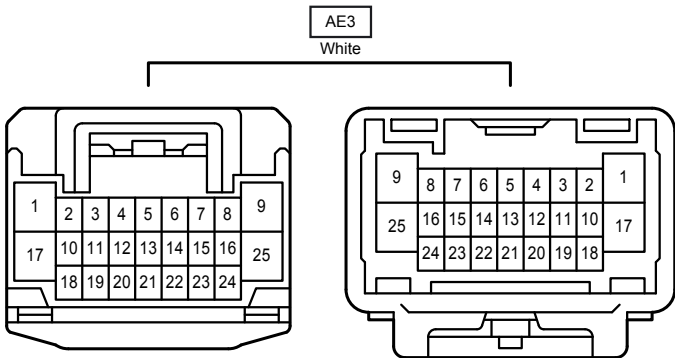
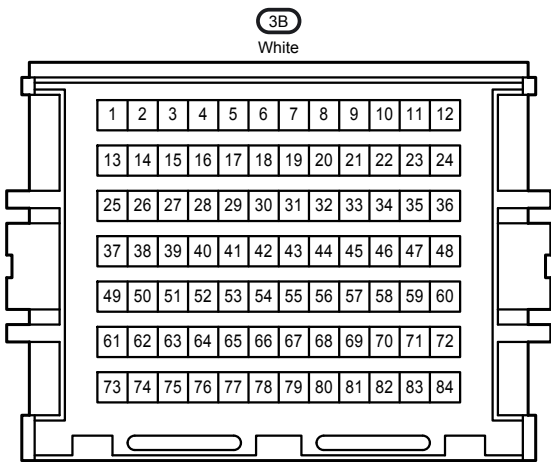
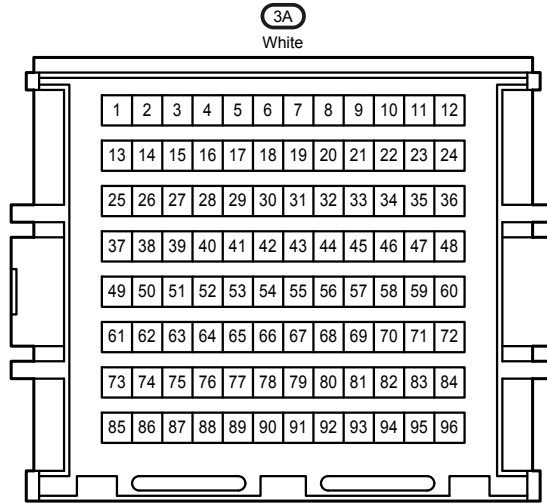
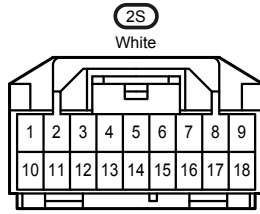
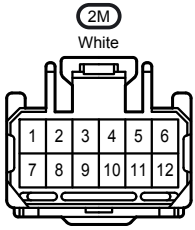

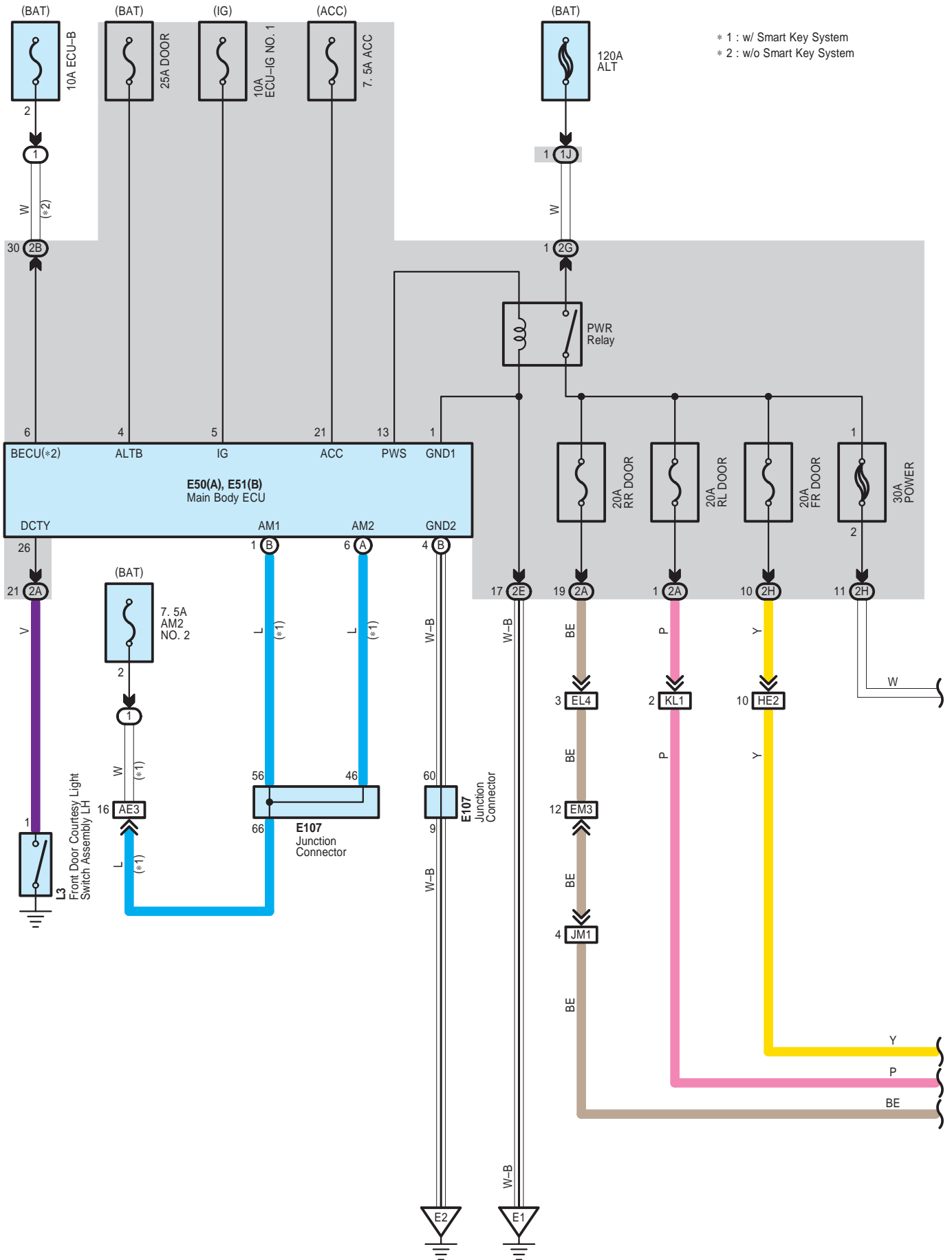

\* 1 : w/ Smart Key System  
 \* 2 : w/o Smart Key System

Power Window <Except TMC Made>

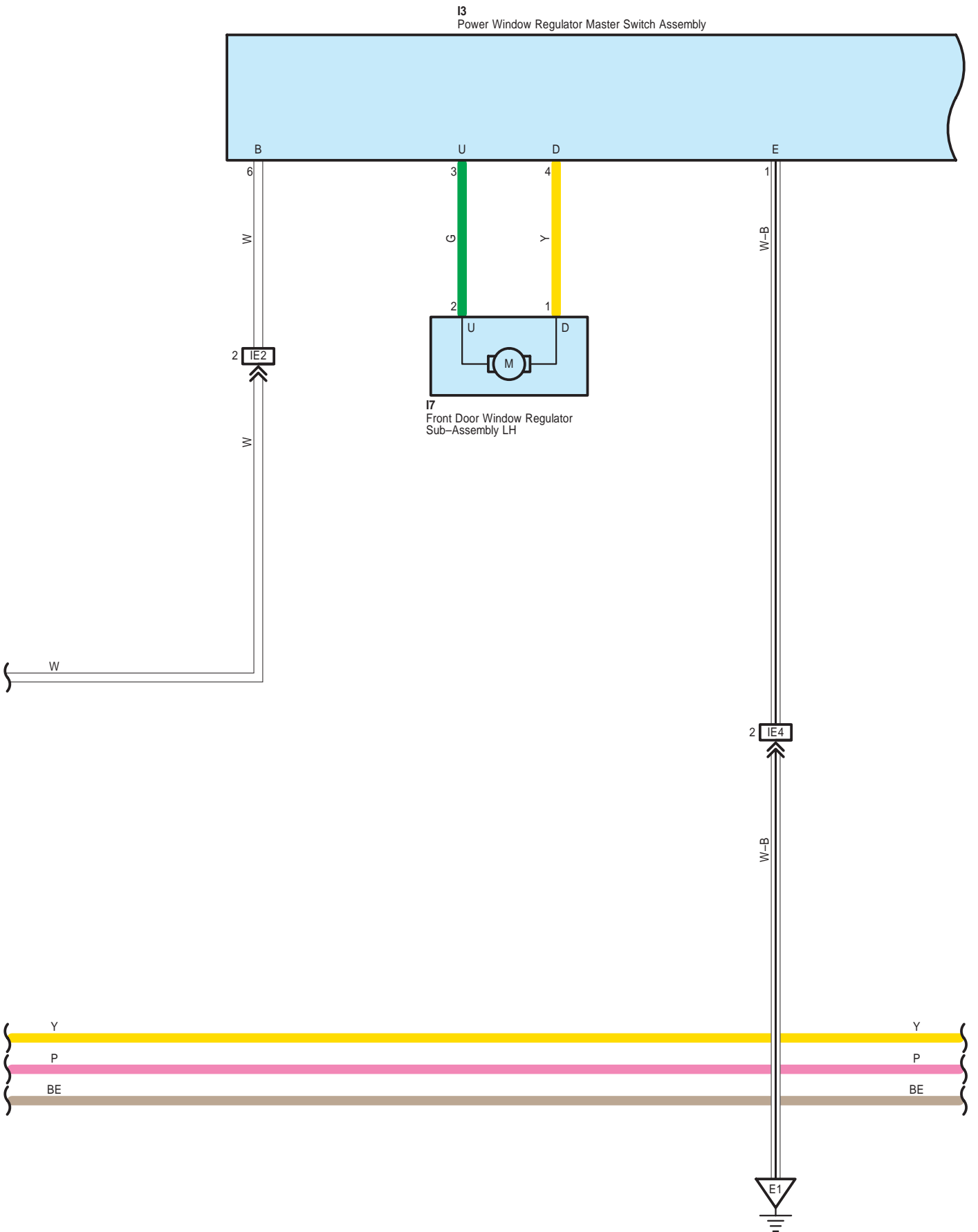

I3  
Power Window Regulator Master Switch Assembly

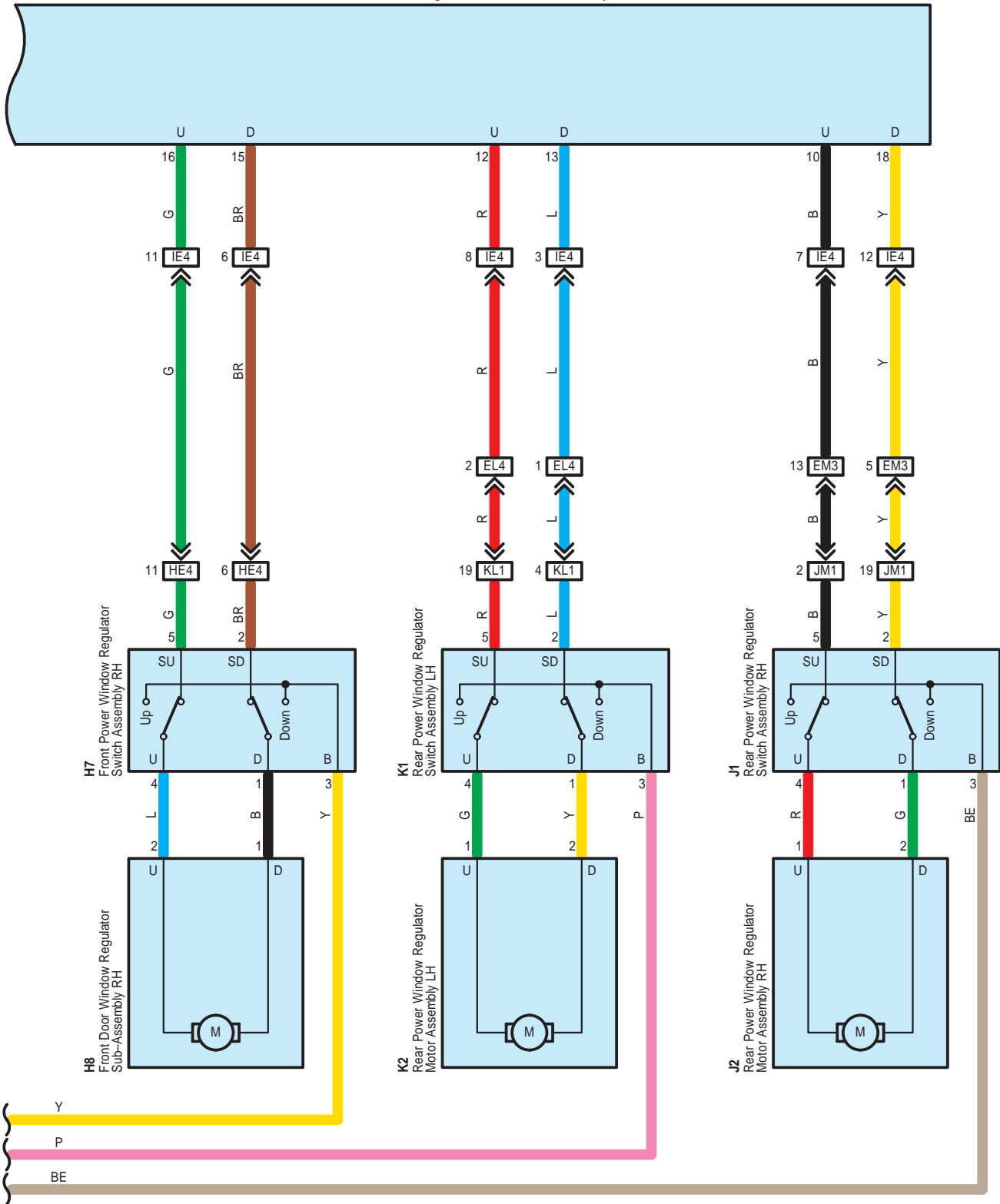

Power Window <Except TMC Made>

E 50  
White

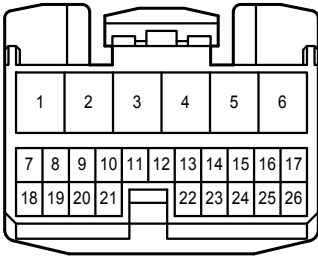

E 51  
White

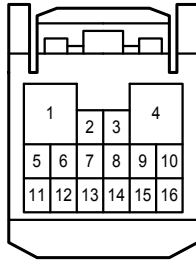

E107  
White

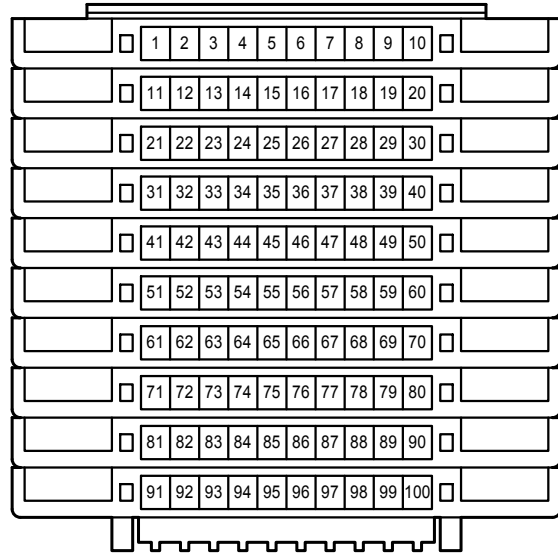

H 7  
White

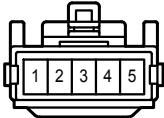

H 8  
Black

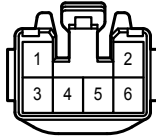

I 3  
White

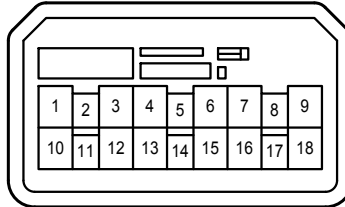

I 7  
Black

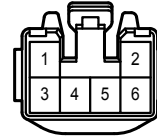

J 1  
White

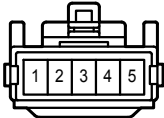

J 2  
Black

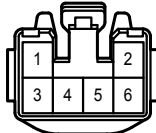

K 1  
White

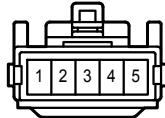

K 2  
Black

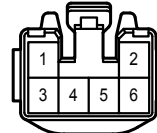

L 3  
Black



1J

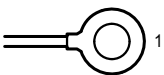

2A

White

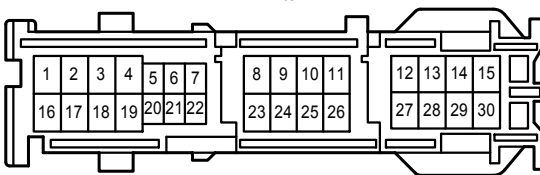

2B

White

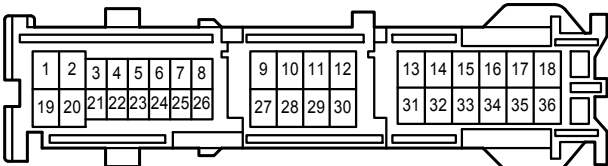

2E

White

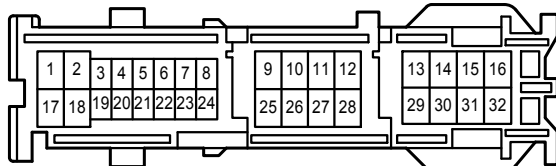

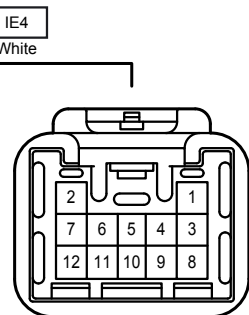
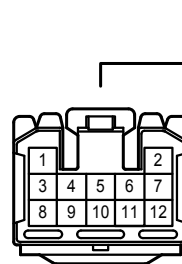
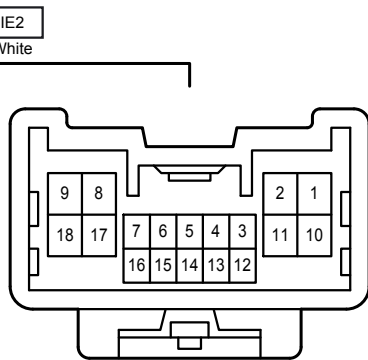
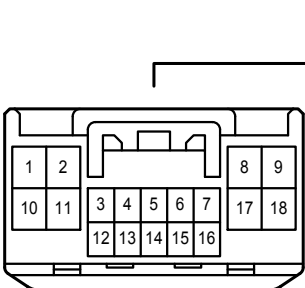
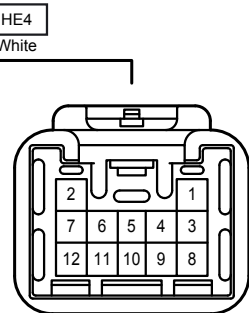
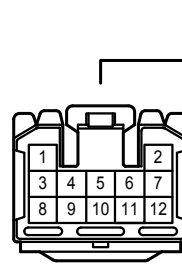
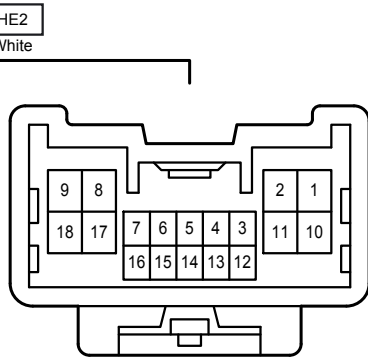
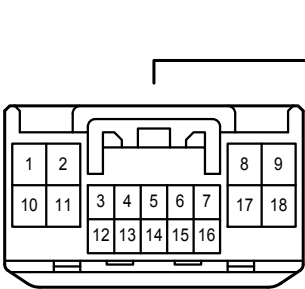
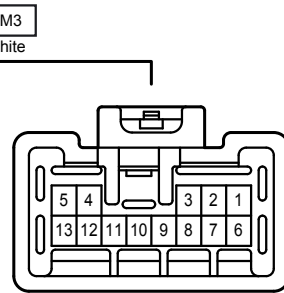
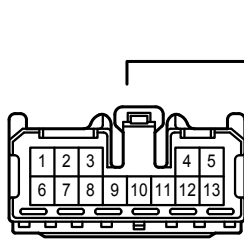
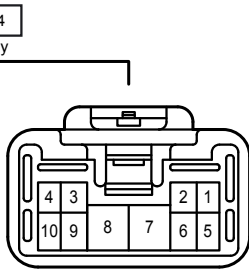
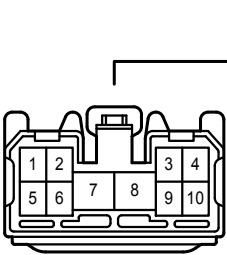
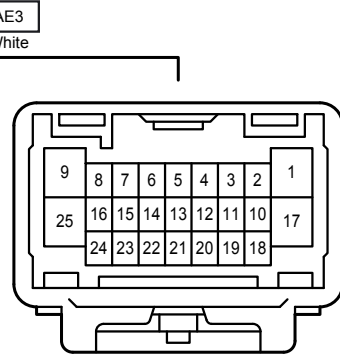
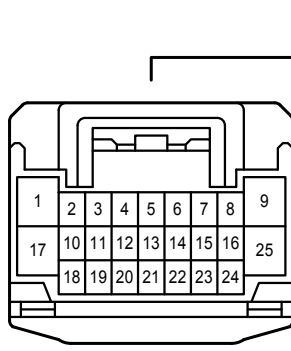
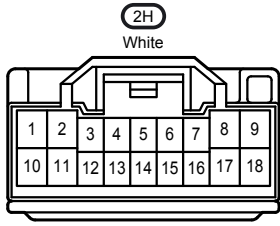
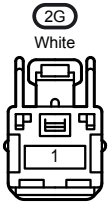



Power Window <Except TMC Made>

JM1  
White

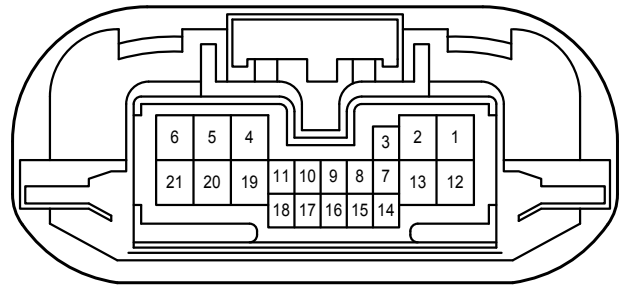
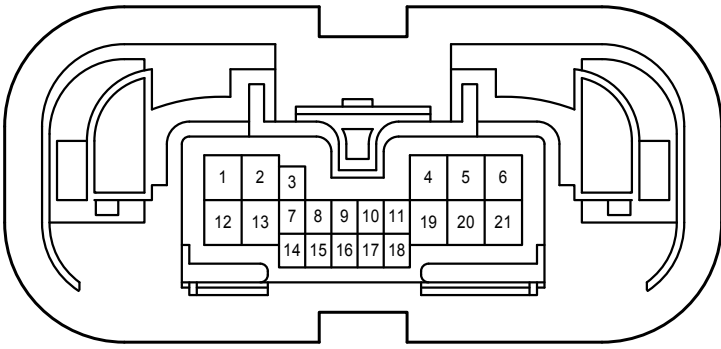

KL1  
White

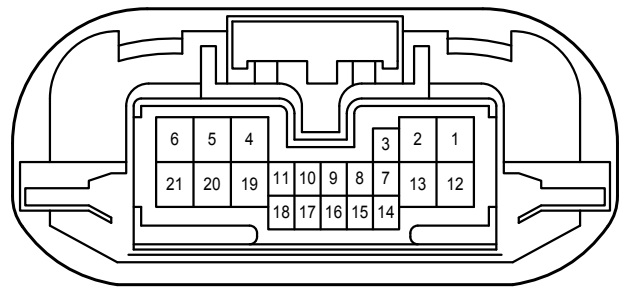
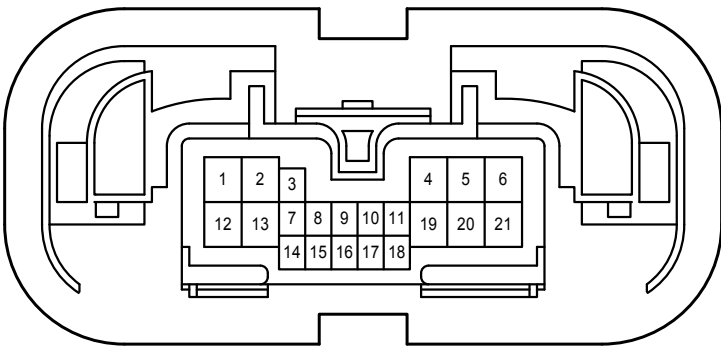

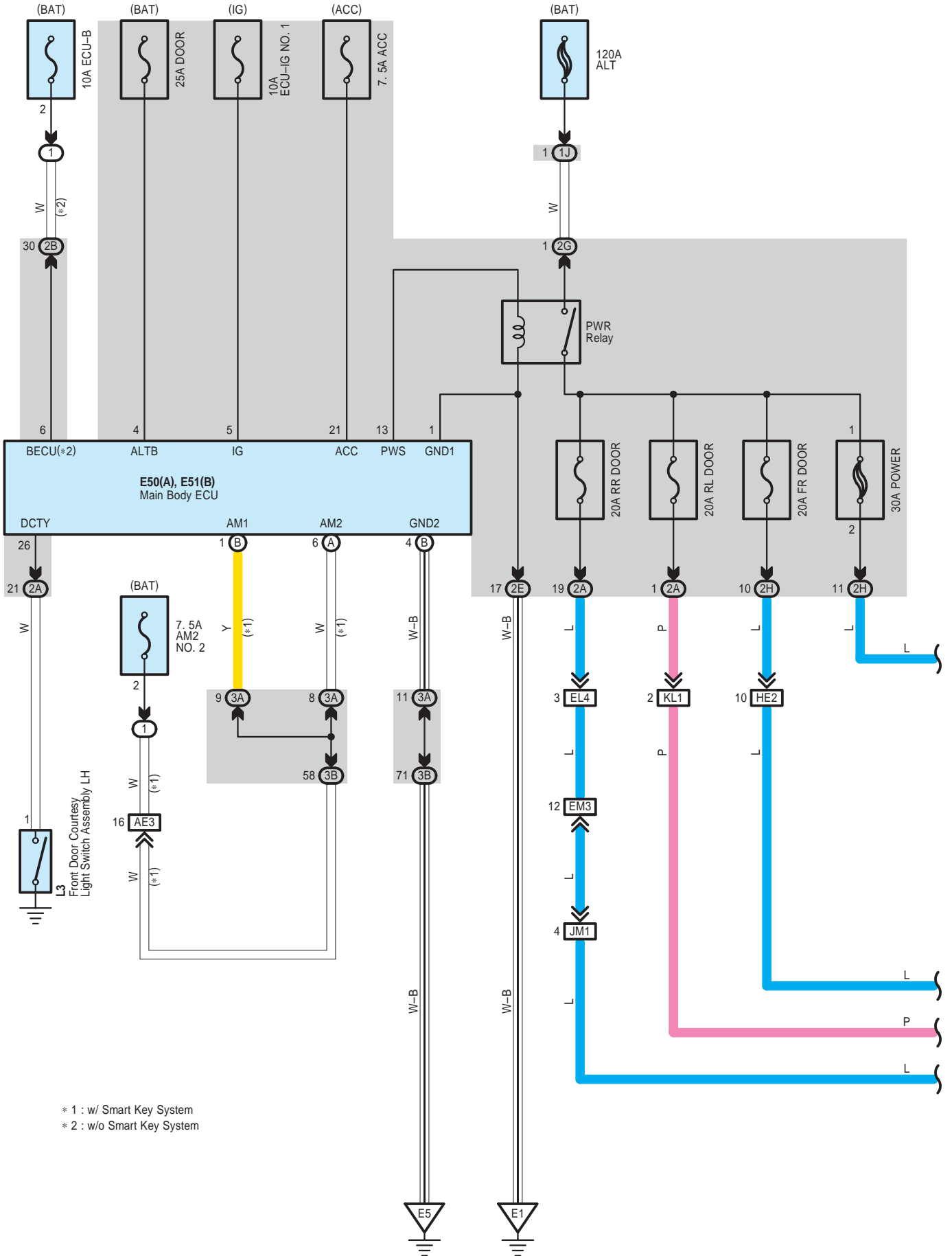

I3  
Power Window Regulator Master Switch Assembly

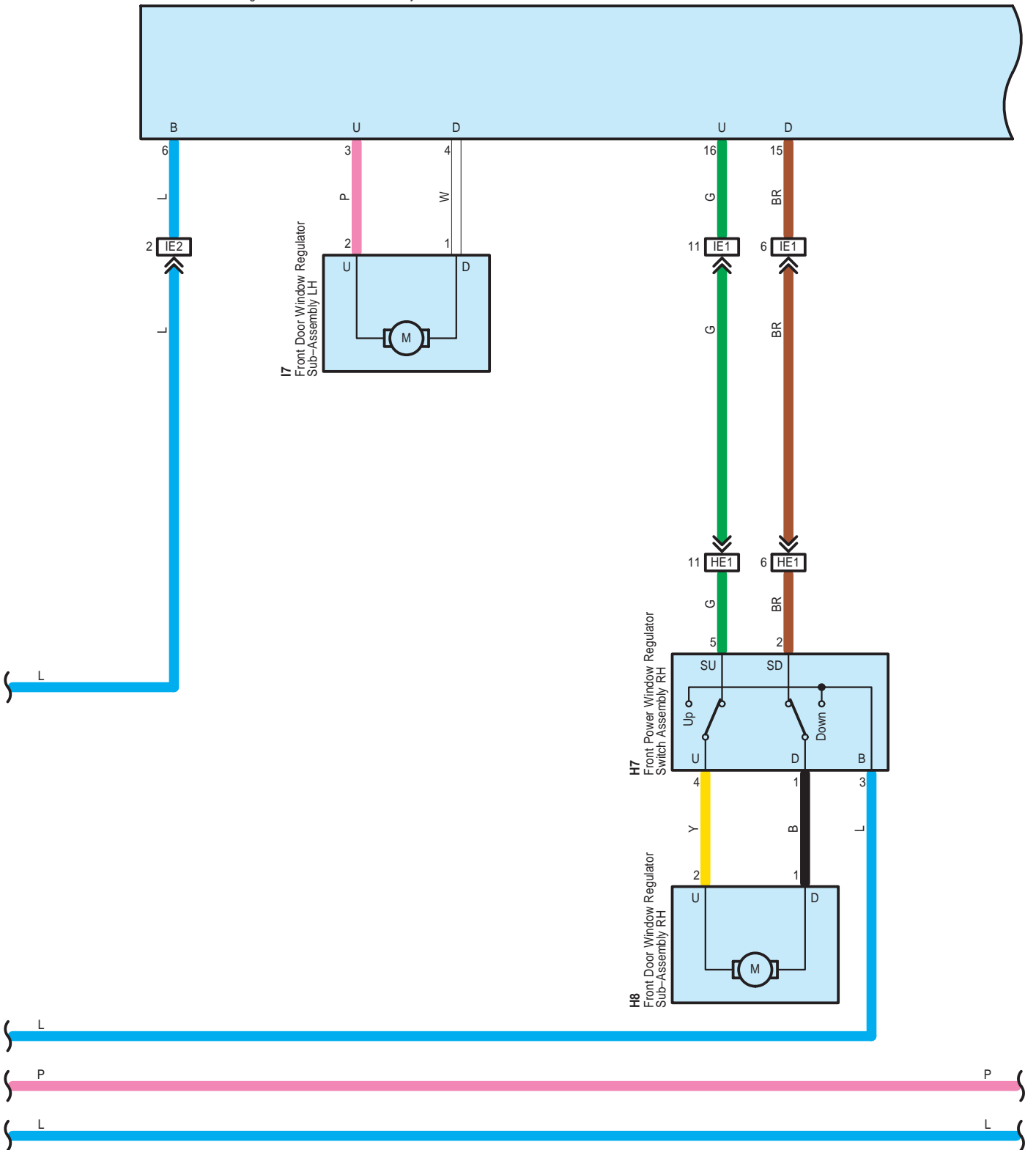

13  
Power Window Regulator Master Switch Assembly

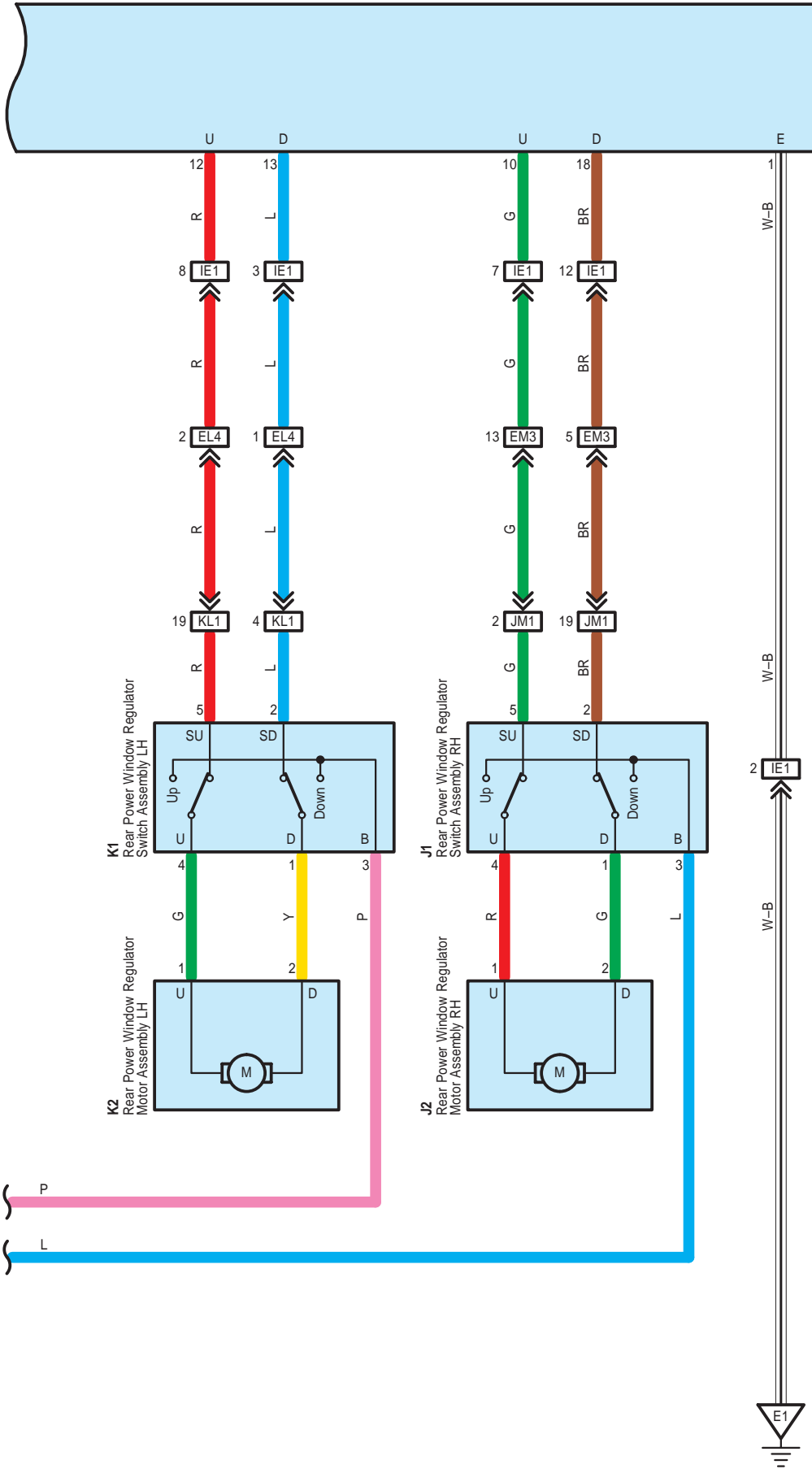

E 50  
White

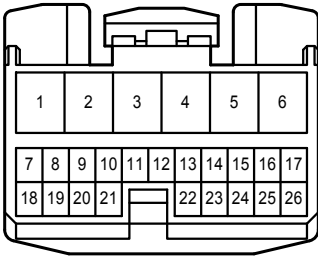

E 51  
White

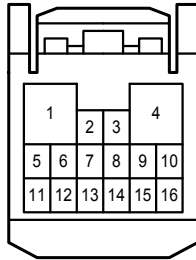

H 7  
White

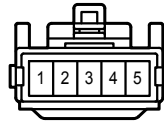

H 8  
Black

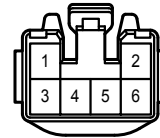

I 3  
White

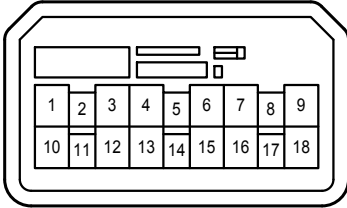

I 7  
Black



J 1  
White

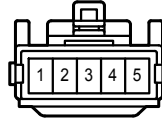

J 2  
Black

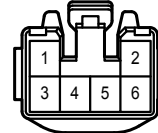

K 1  
White

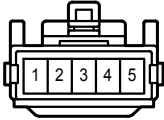

K 2  
Black

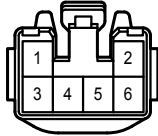

L 3  
Black



(1J)

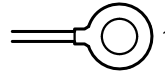

(2A)  
White

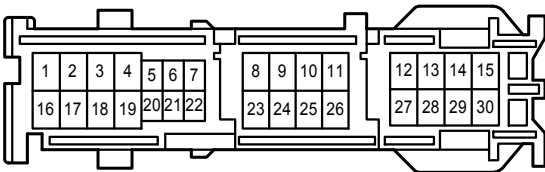

(2B)  
White

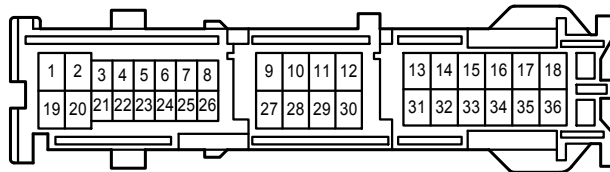

(2E)  
White

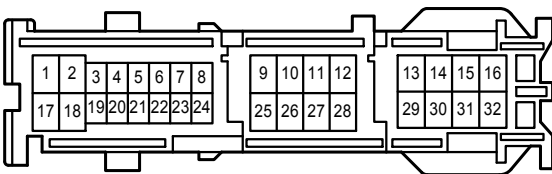

(2G)  
White

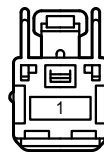

(2H)  
White

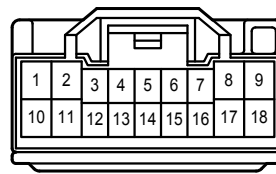

3A  
White

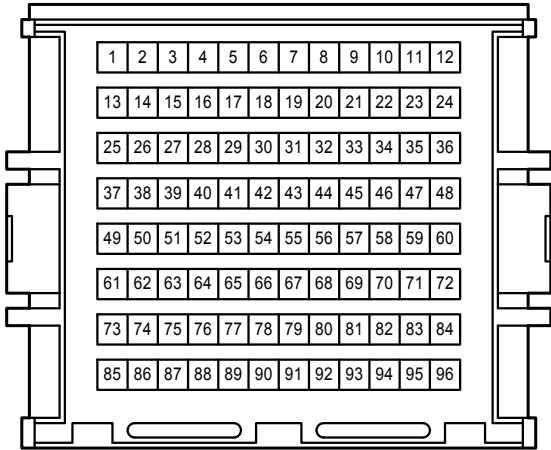

3B  
White

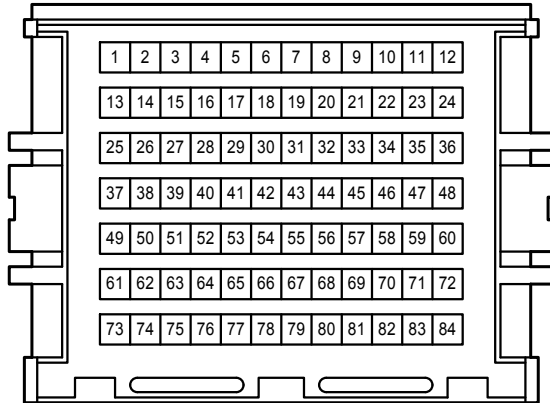

AE3  
White

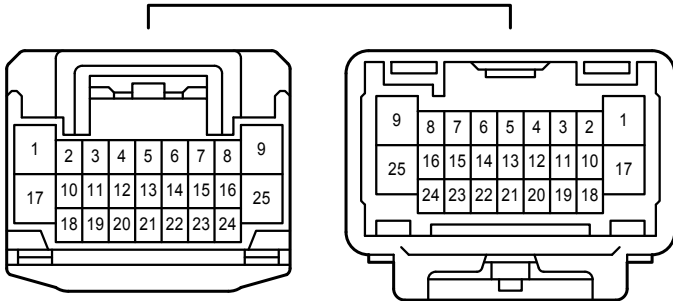

EL4  
Gray

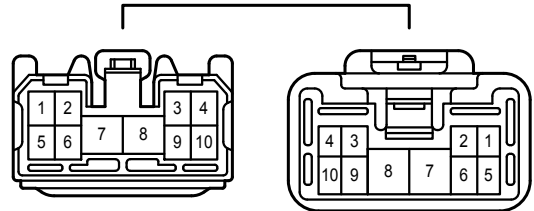

EM3  
White

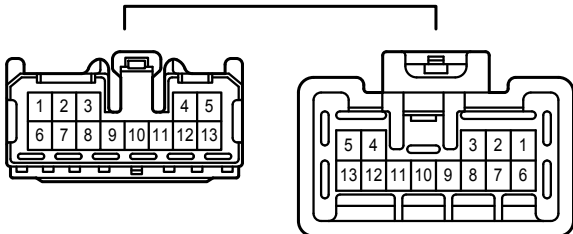

HE1  
Blue

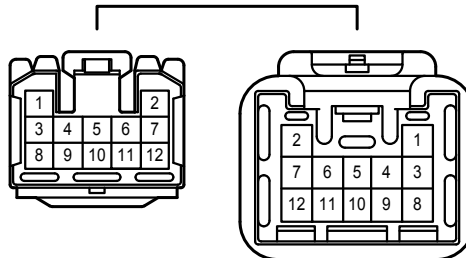

HE2  
White

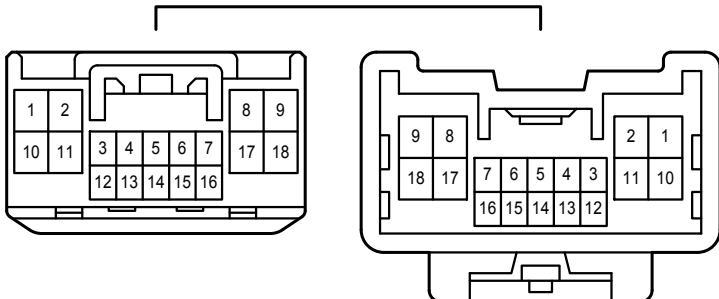

IE1  
Blue

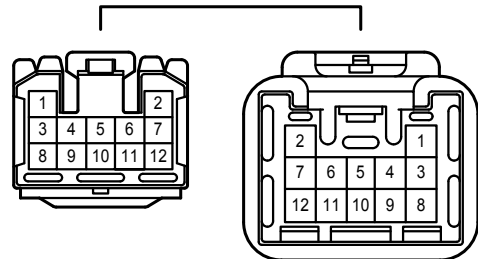

IE2  
White

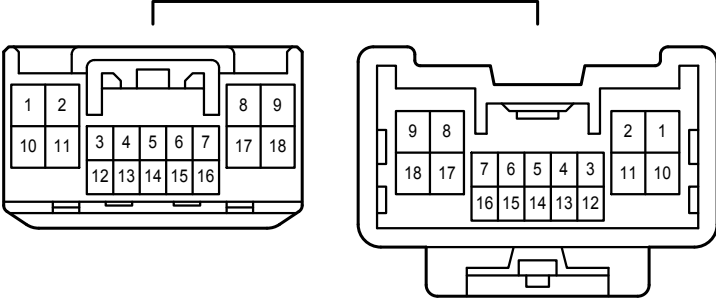

JM1  
White

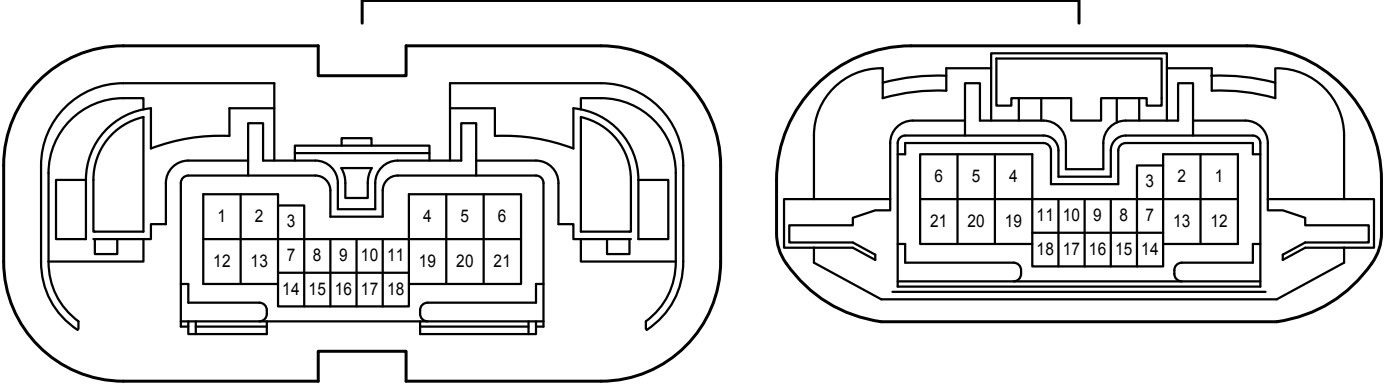

KL1  
White

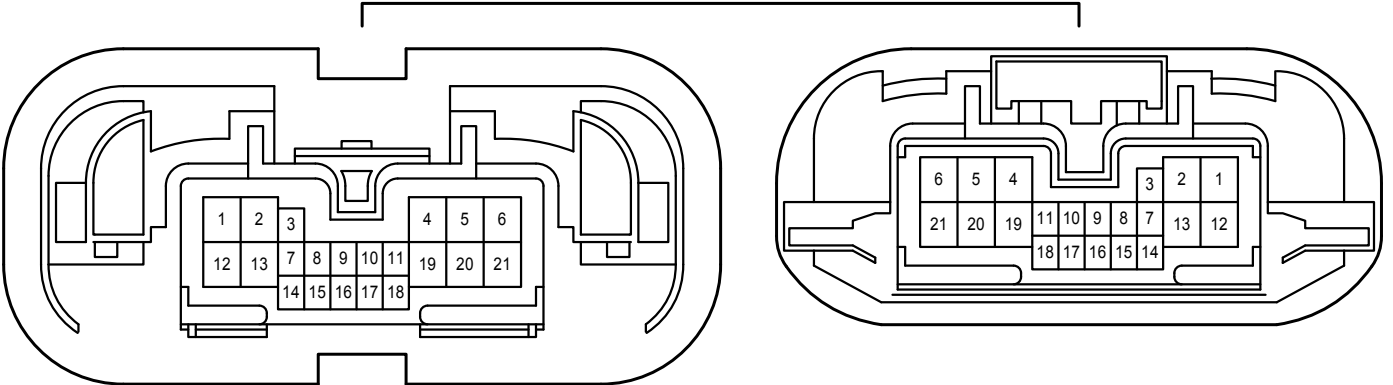

Remote Control Mirror <Except TMC Made>

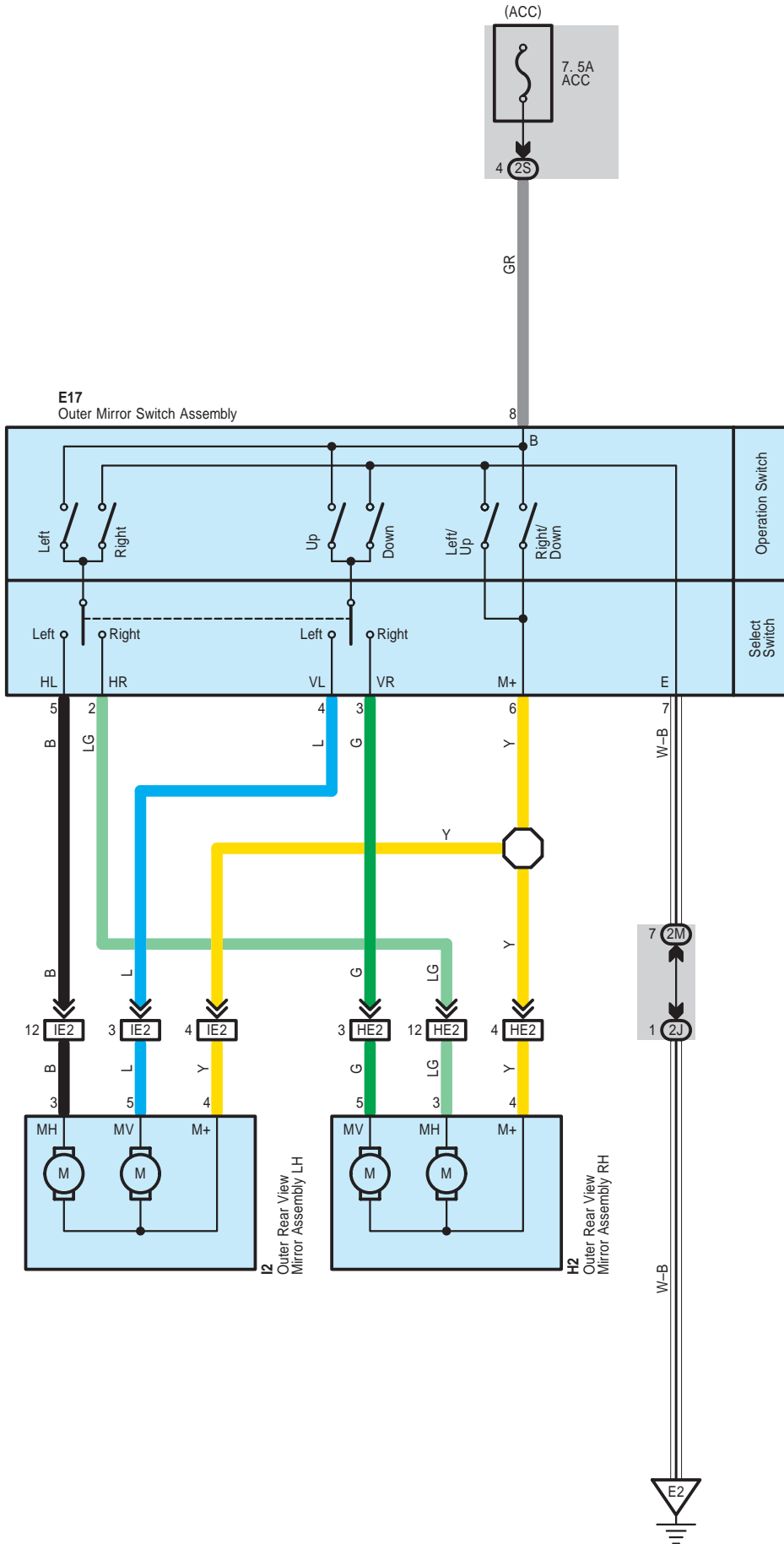



Remote Control Mirror <Except TMC Made>

E 17

White

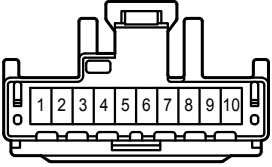

H 2

White

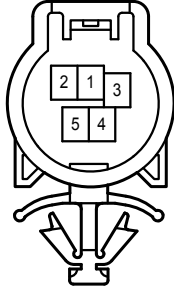

I 2

White

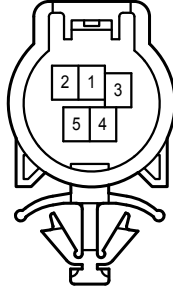

2J

White

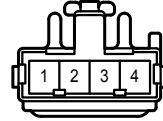

2M

White

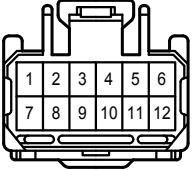

2S

White

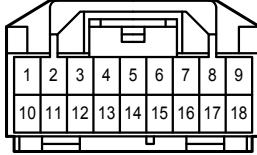

HE2

White

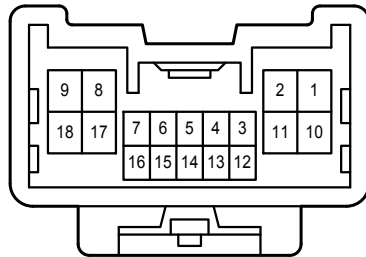
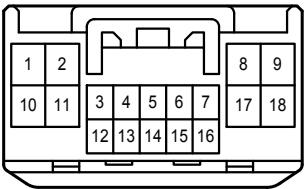

IE2

White

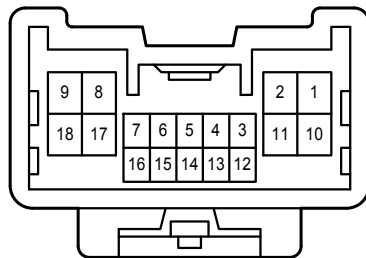
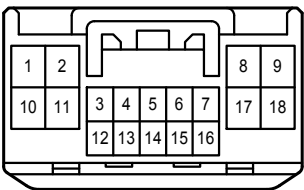

Remote Control Mirror <TMC Made>

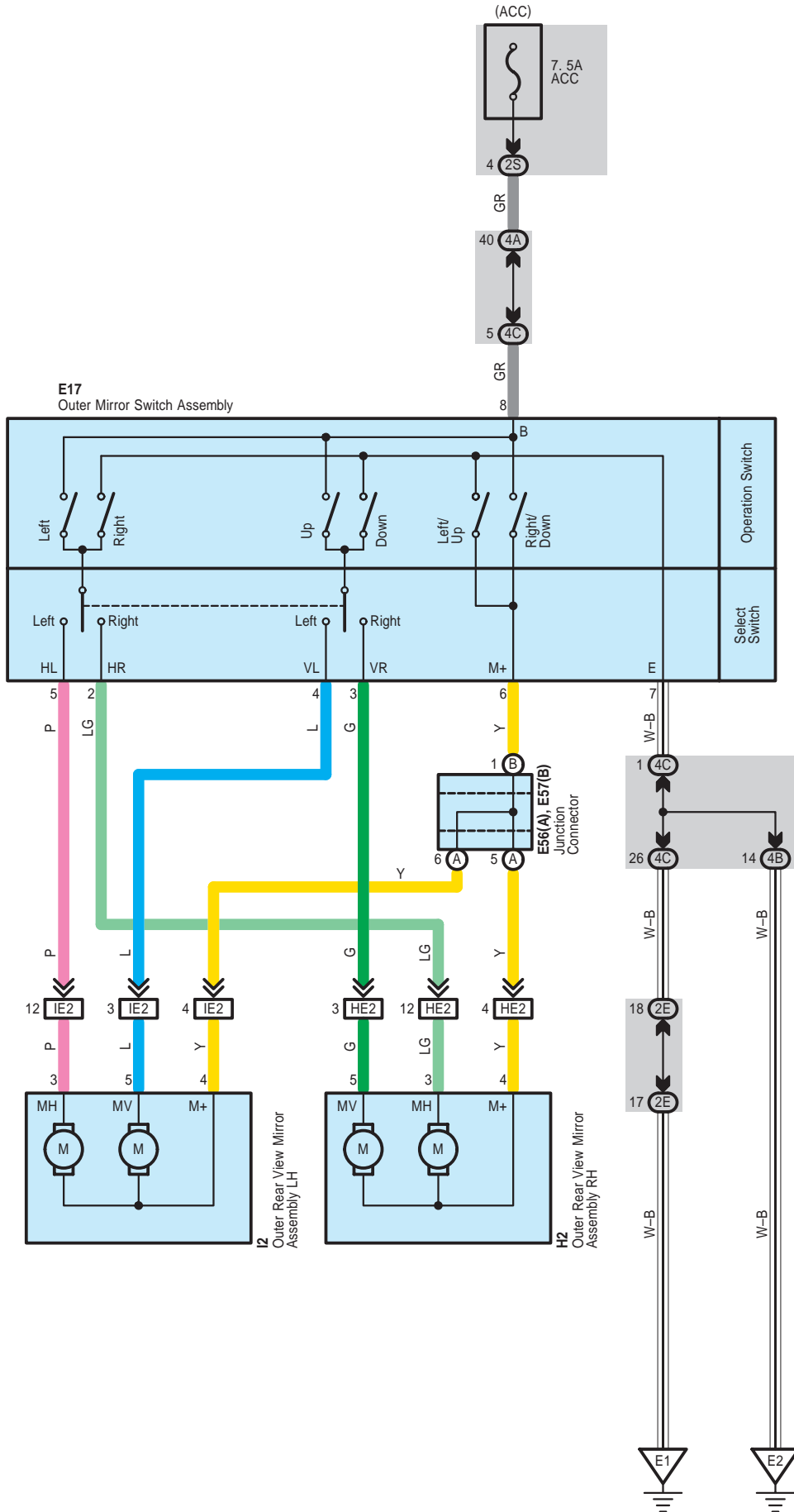

Remote Control Mirror <TMC Made>

E 17

White

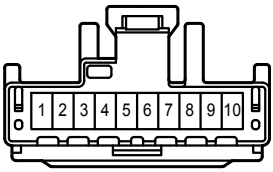

E 56

White

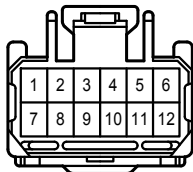

E 57

White

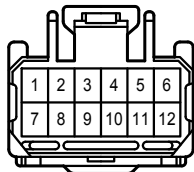

H 2

White

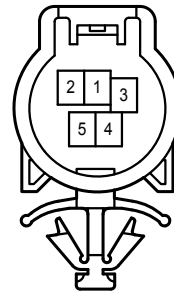

I 2

White

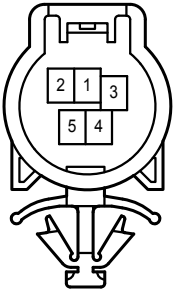

2E

White

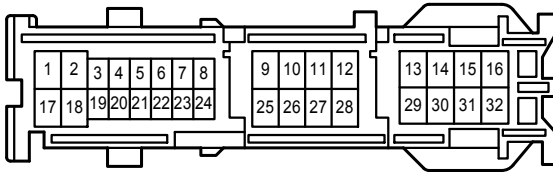

2S

White

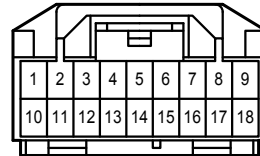

4A

White

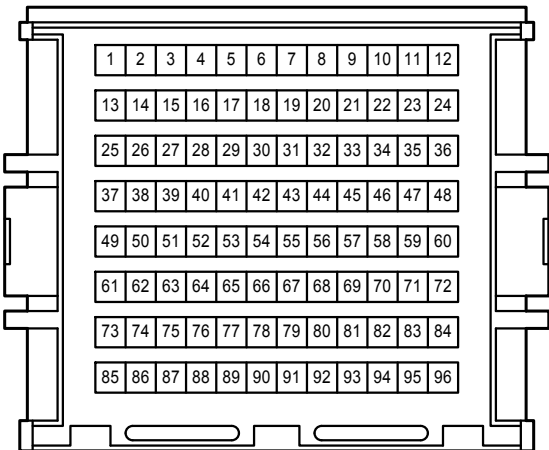

4B

White

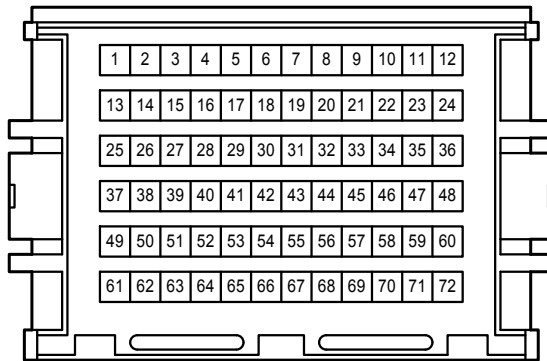

4C

White

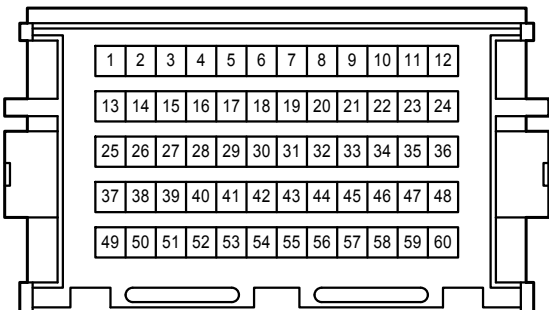

HE2  
White

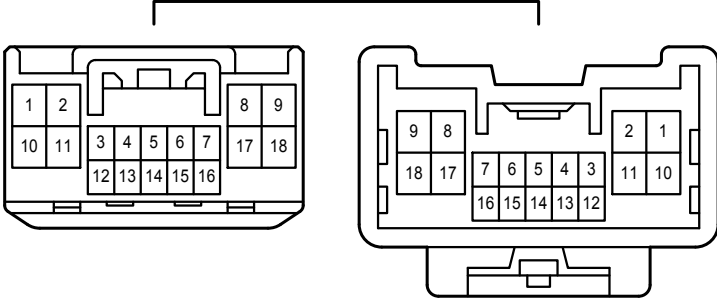

IE2  
White

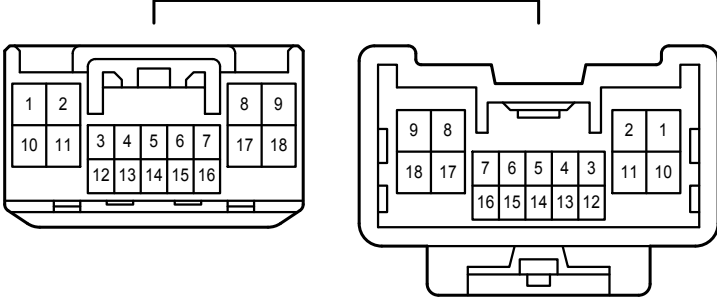

Seat Belt Warning <TMC Made>

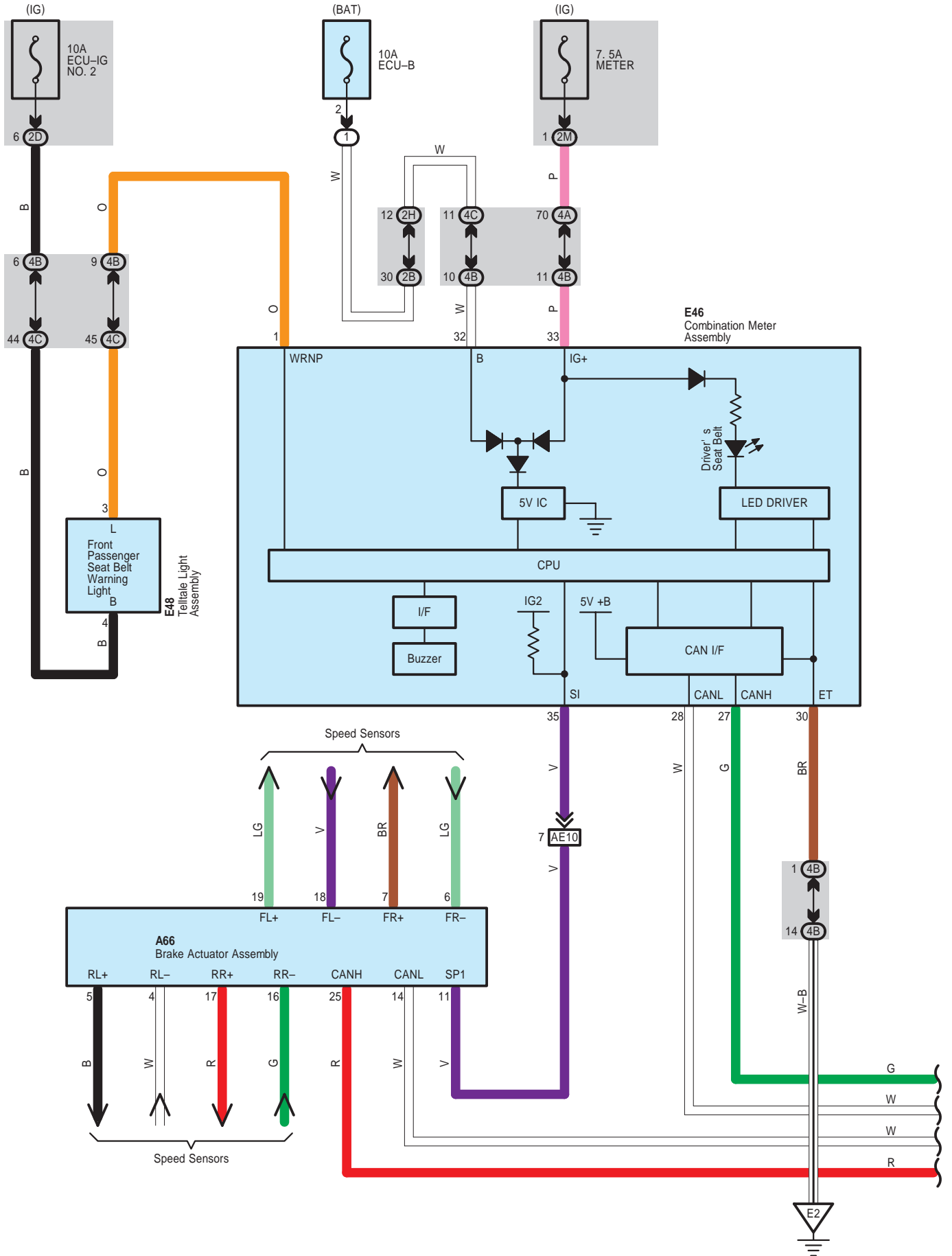

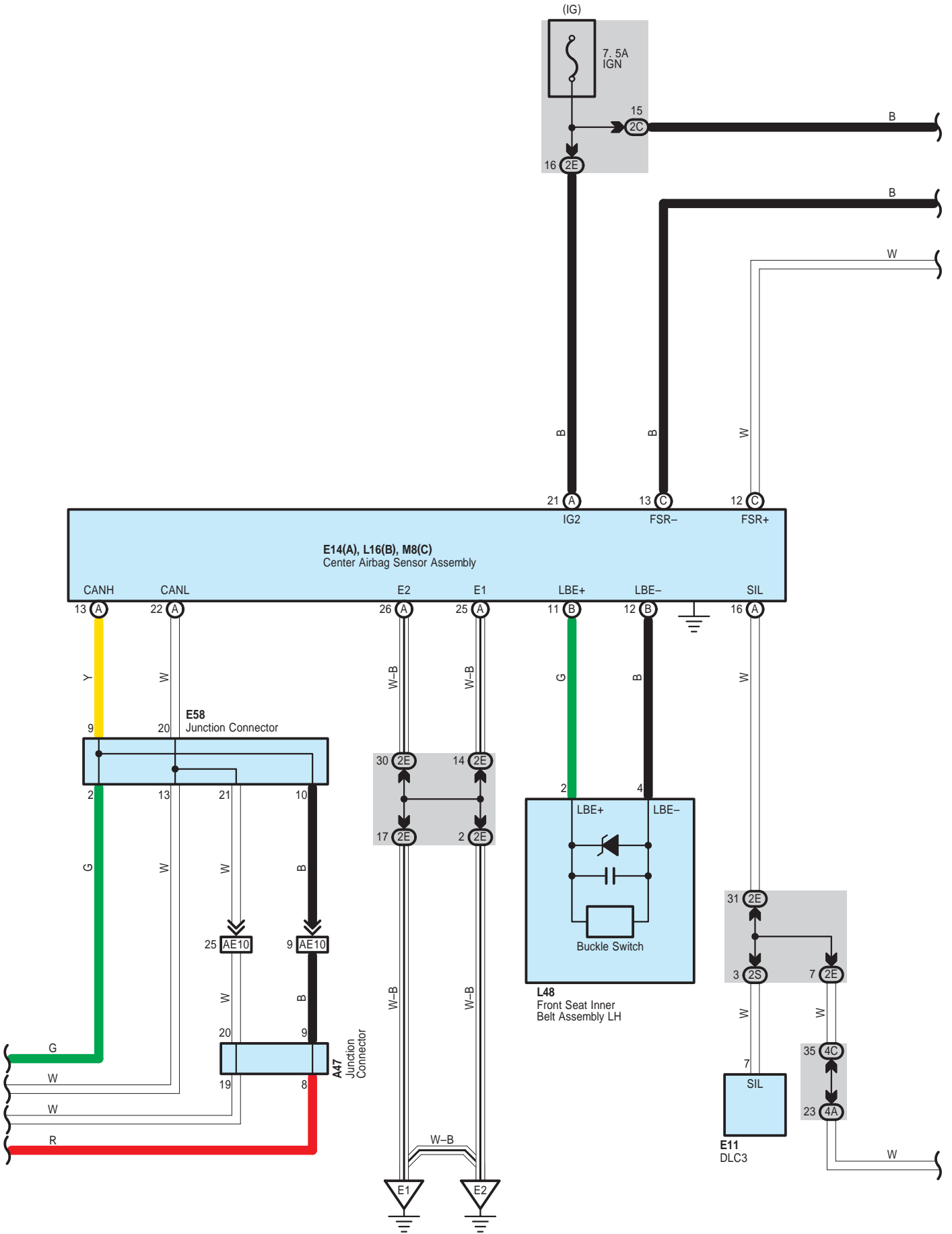

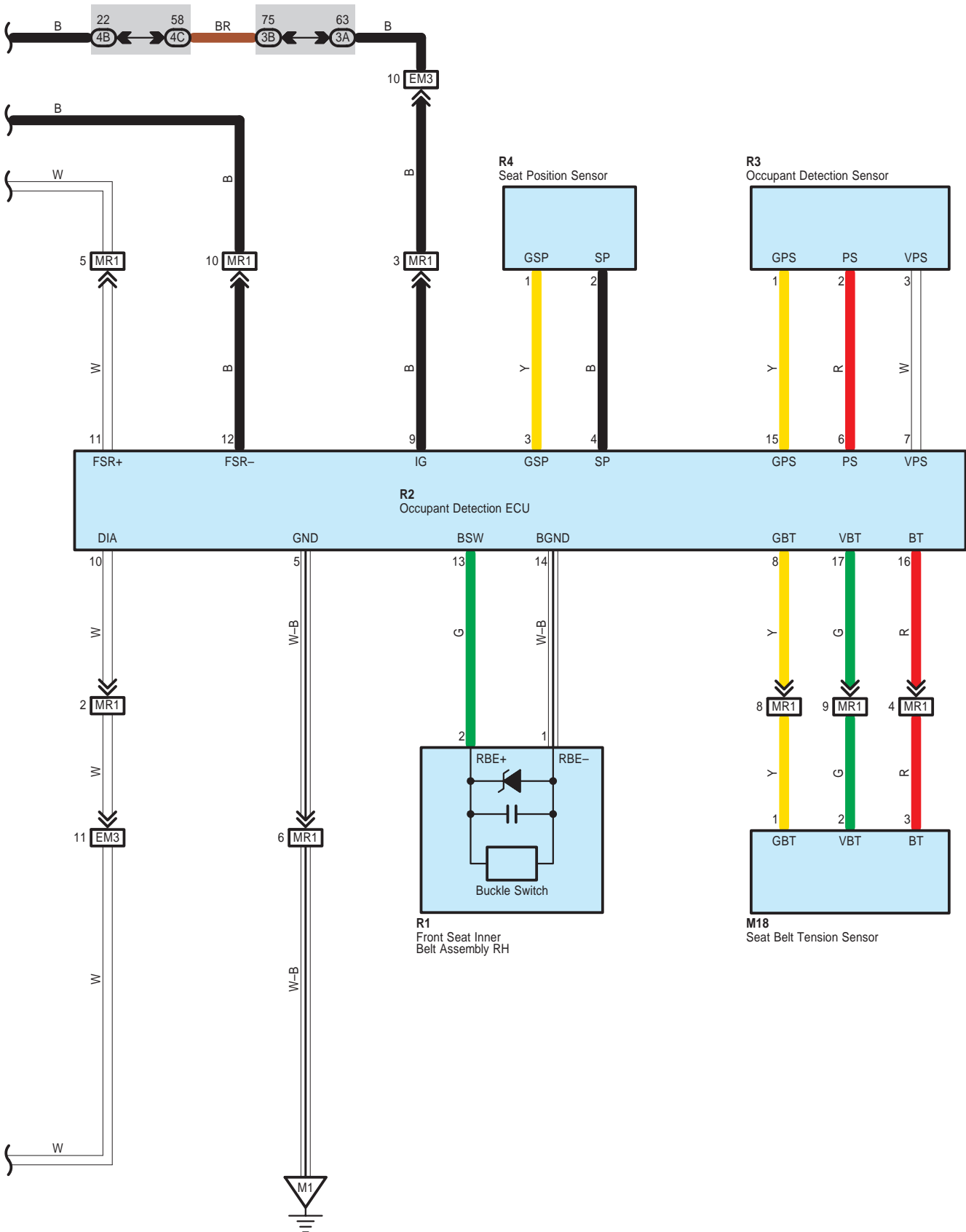

Seat Belt Warning <TMC Made>

A 47  
White

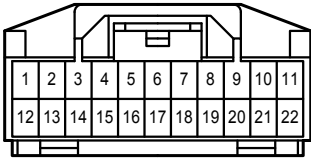

A 66  
Black

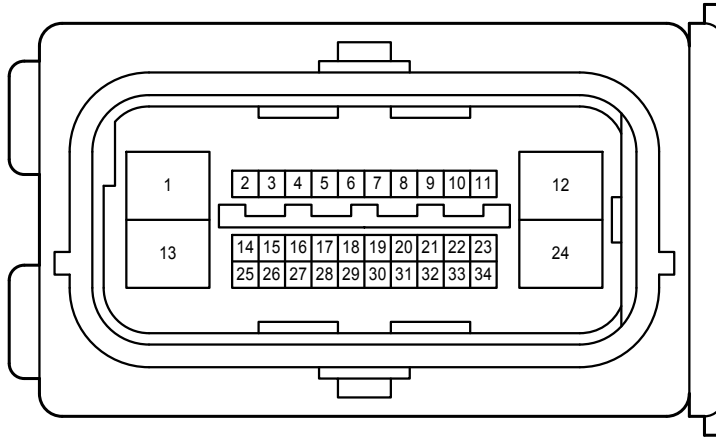

E 11  
White

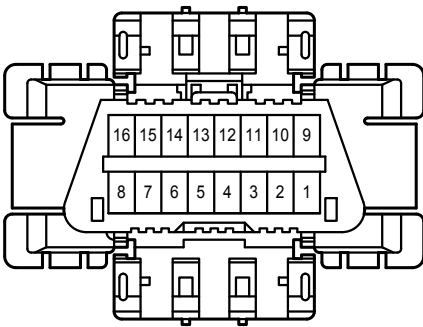

E 14  
Yellow

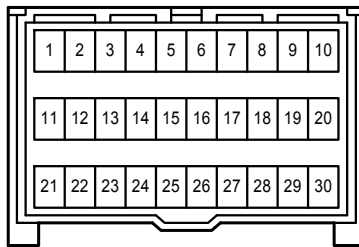

E 46  
White

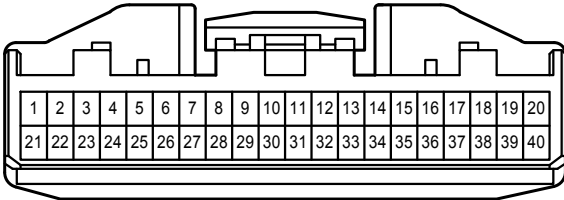

E 48  
Black

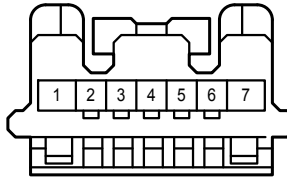

E 58  
Gray

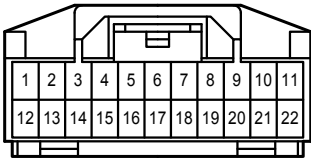

L 16  
Yellow

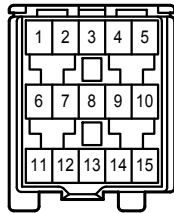

L 48  
White



M 8  
Yellow

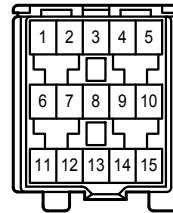

M 18  
White

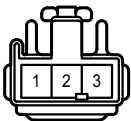

R 1  
White

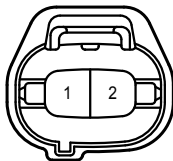

R 2  
Black

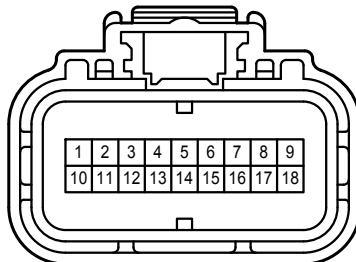

R 3  
Gray

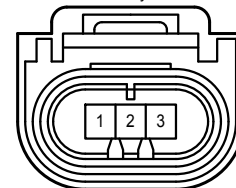



Seat Belt Warning <TMC Made>

R 4

Black



2B

White

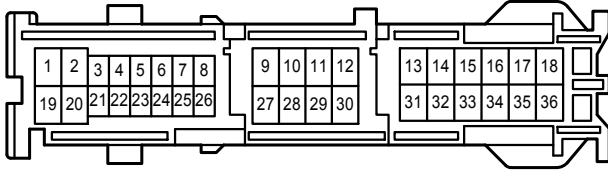

2C

White

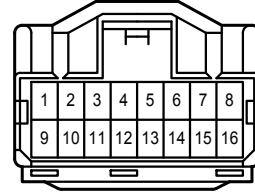

2D

White

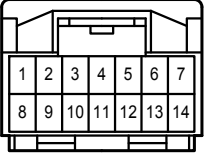

2E

White

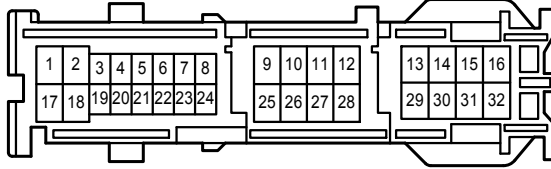

2H

White

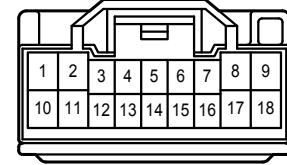

2M

White

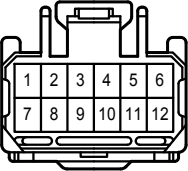

2S

White

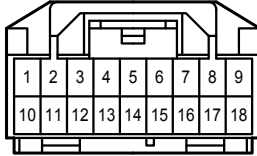

3A

White

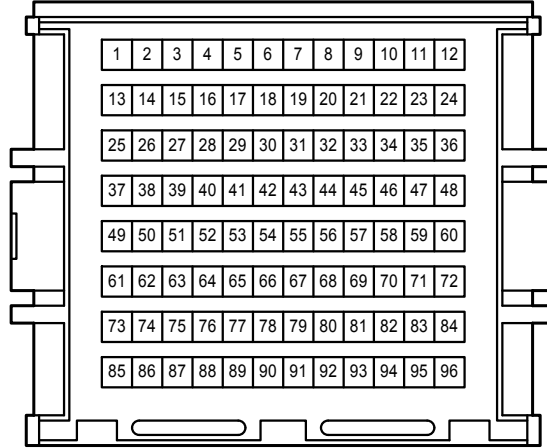

3B

White

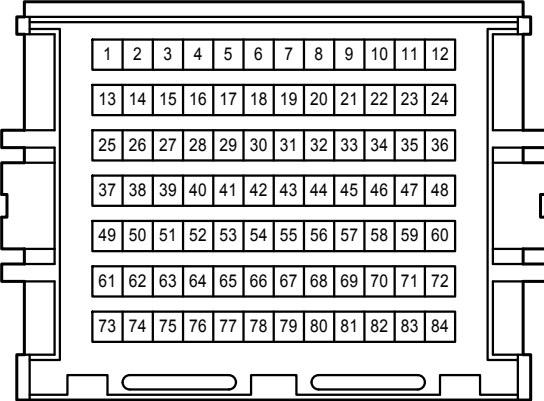

4A

White

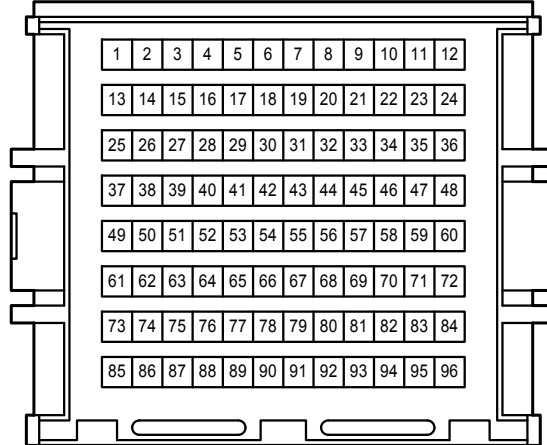

Seat Belt Warning <TMC Made>

4B  
White

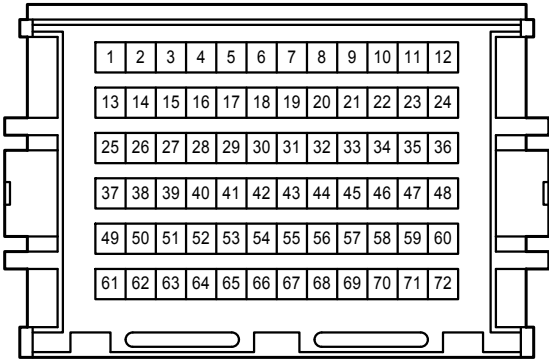

4C  
White

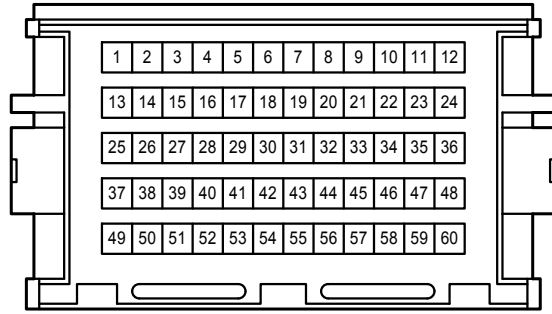

AE10  
Gray

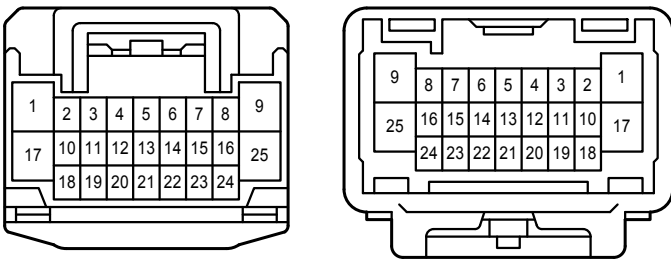

EM3  
White

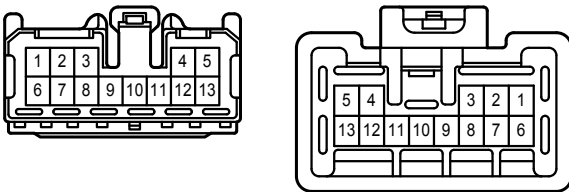

MR1  
Black

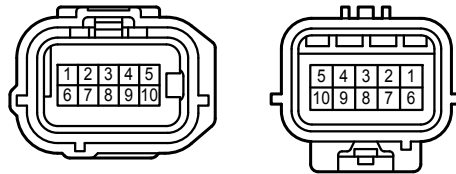

Seat Heater <Except TMC Made>

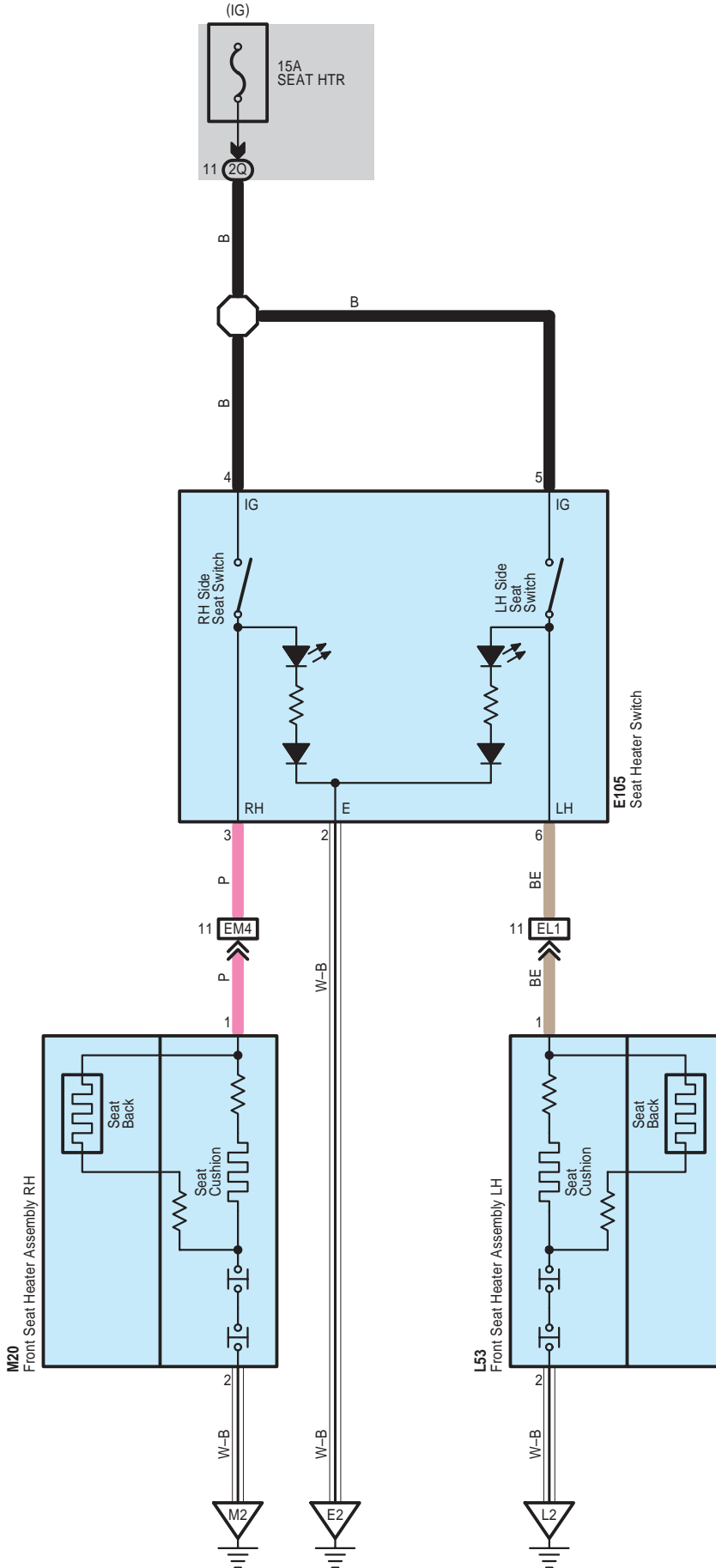

Seat Heater <Except TMC Made>

E105  
Black

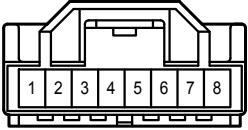

L 53  
Black

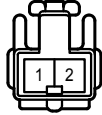

M 20  
Black

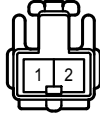

2Q  
White

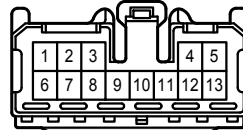

EL1  
White

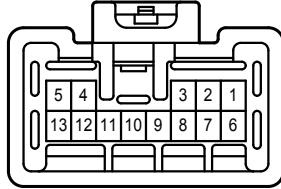
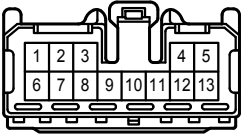

EM4  
Gray

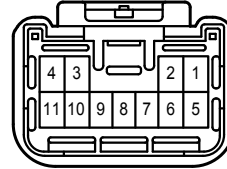
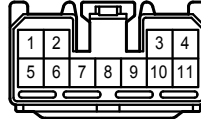

Shift Lock <Except TMC Made>

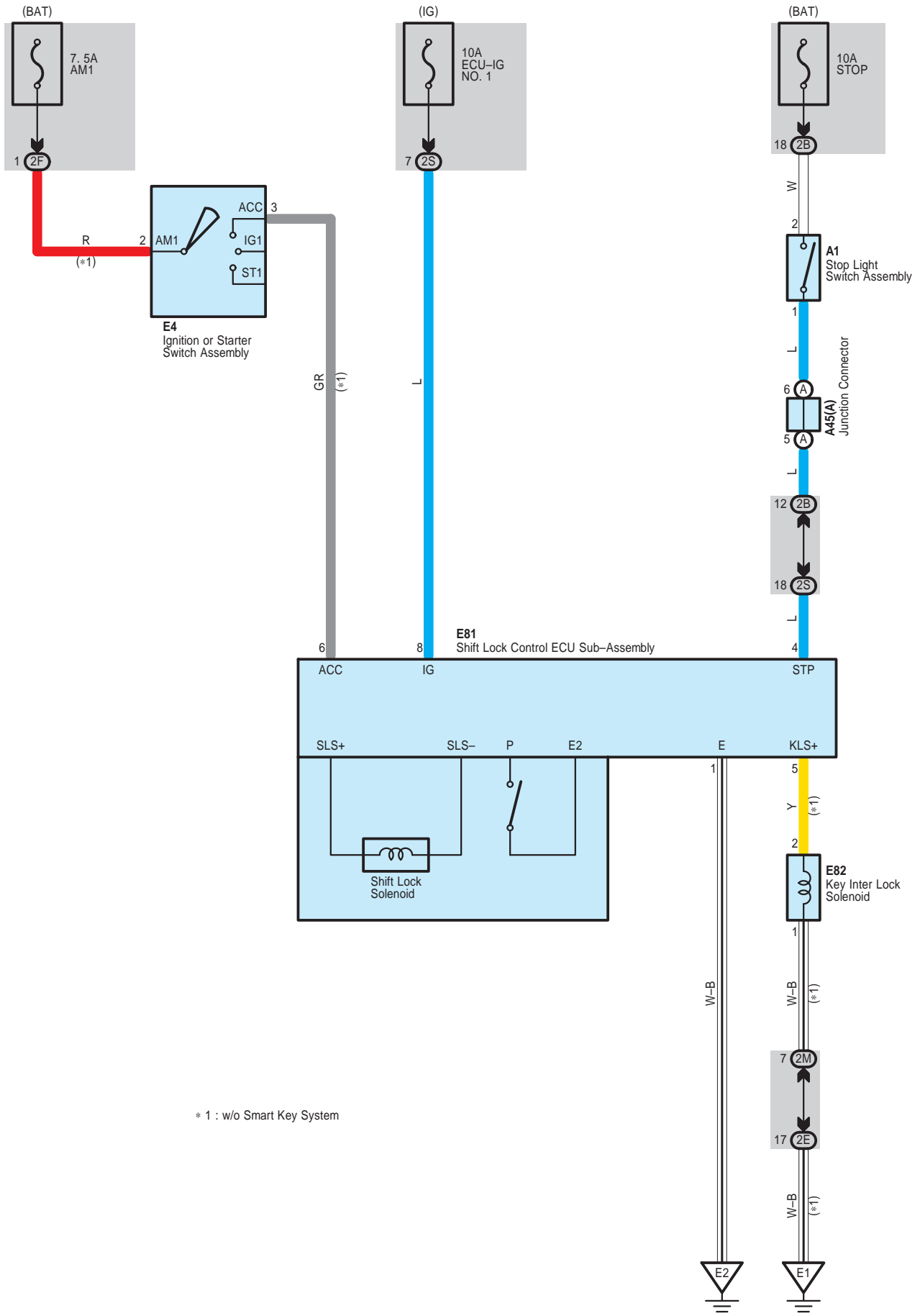

\* 1 : w/o Smart Key System

Shift Lock <Except TMC Made>

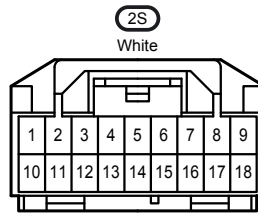
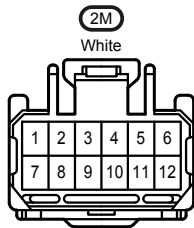
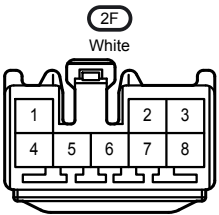
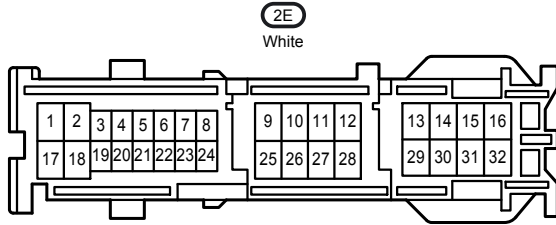
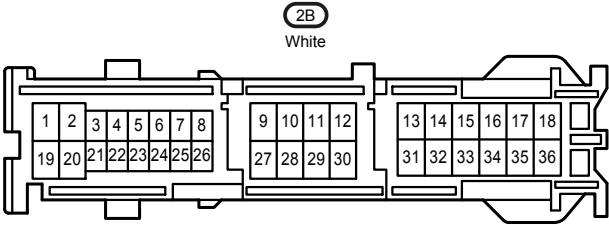
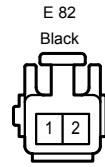
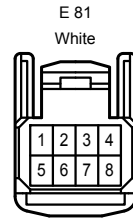
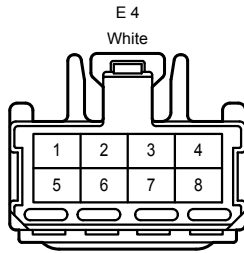
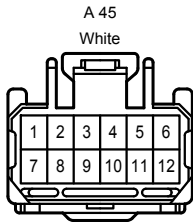
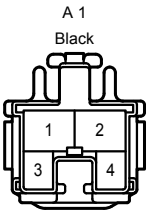

Shift Lock <TMC Made>

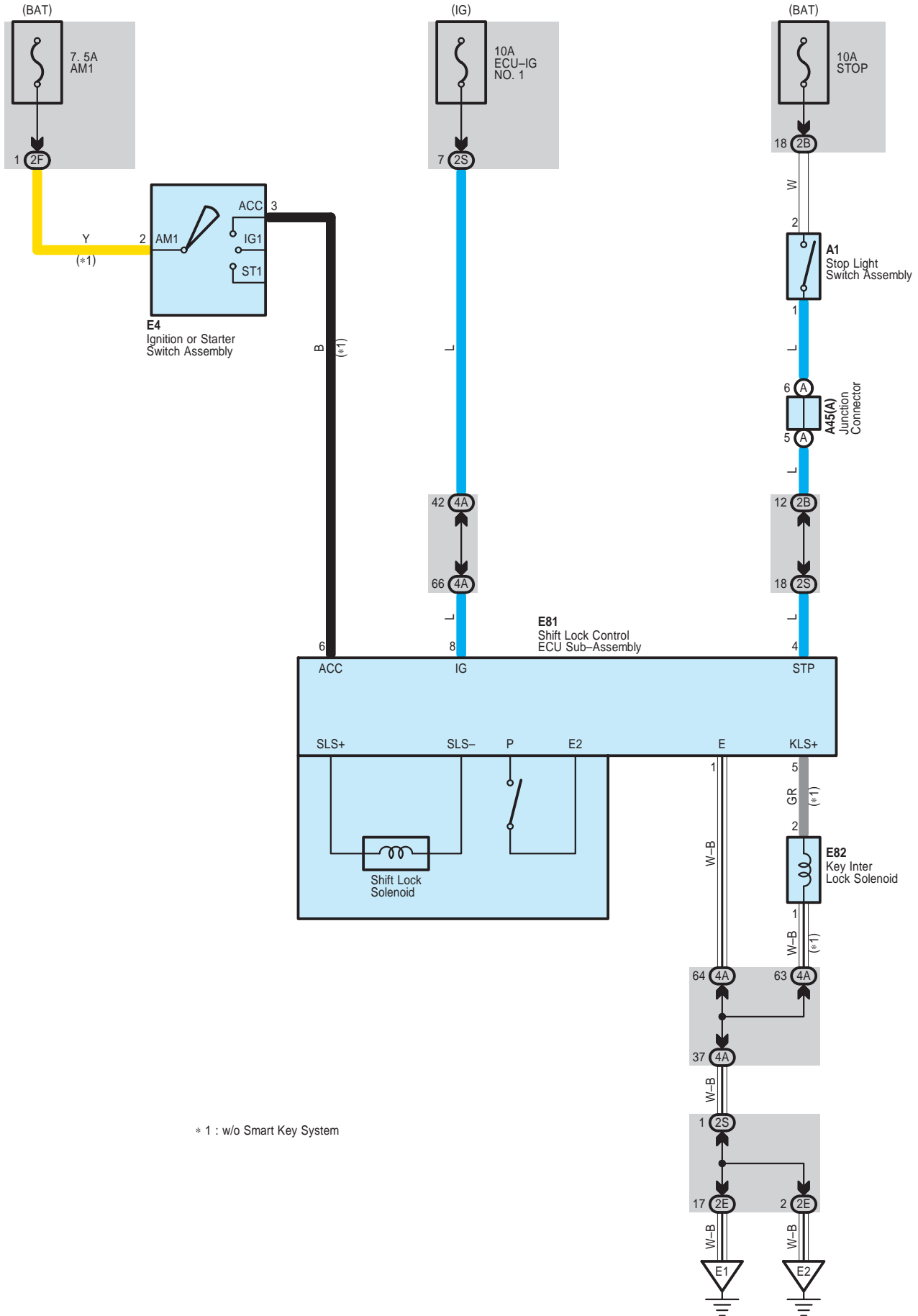

\* 1 : w/o Smart Key System

Shift Lock <TMC Made>

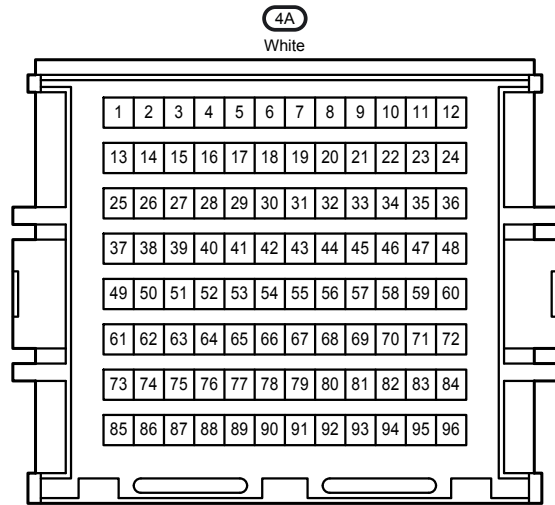
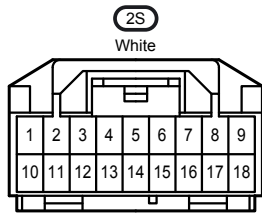
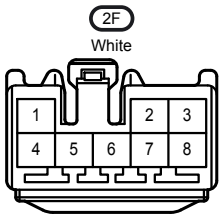
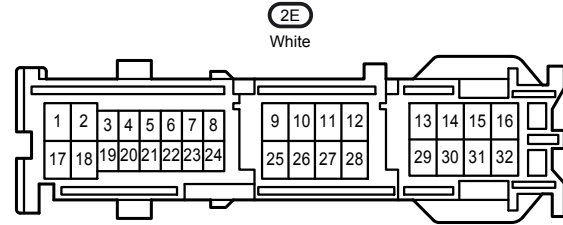
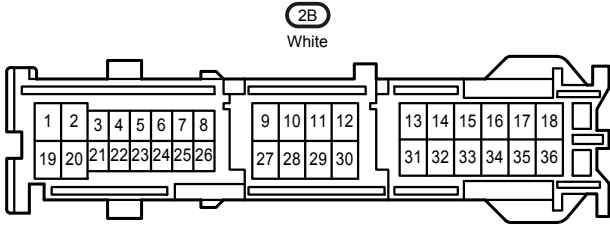
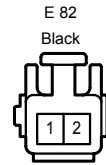
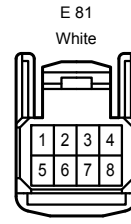
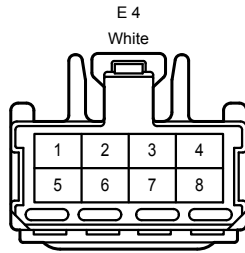
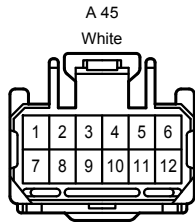
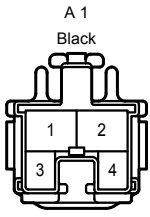



Sliding Roof <Except TMC Made>

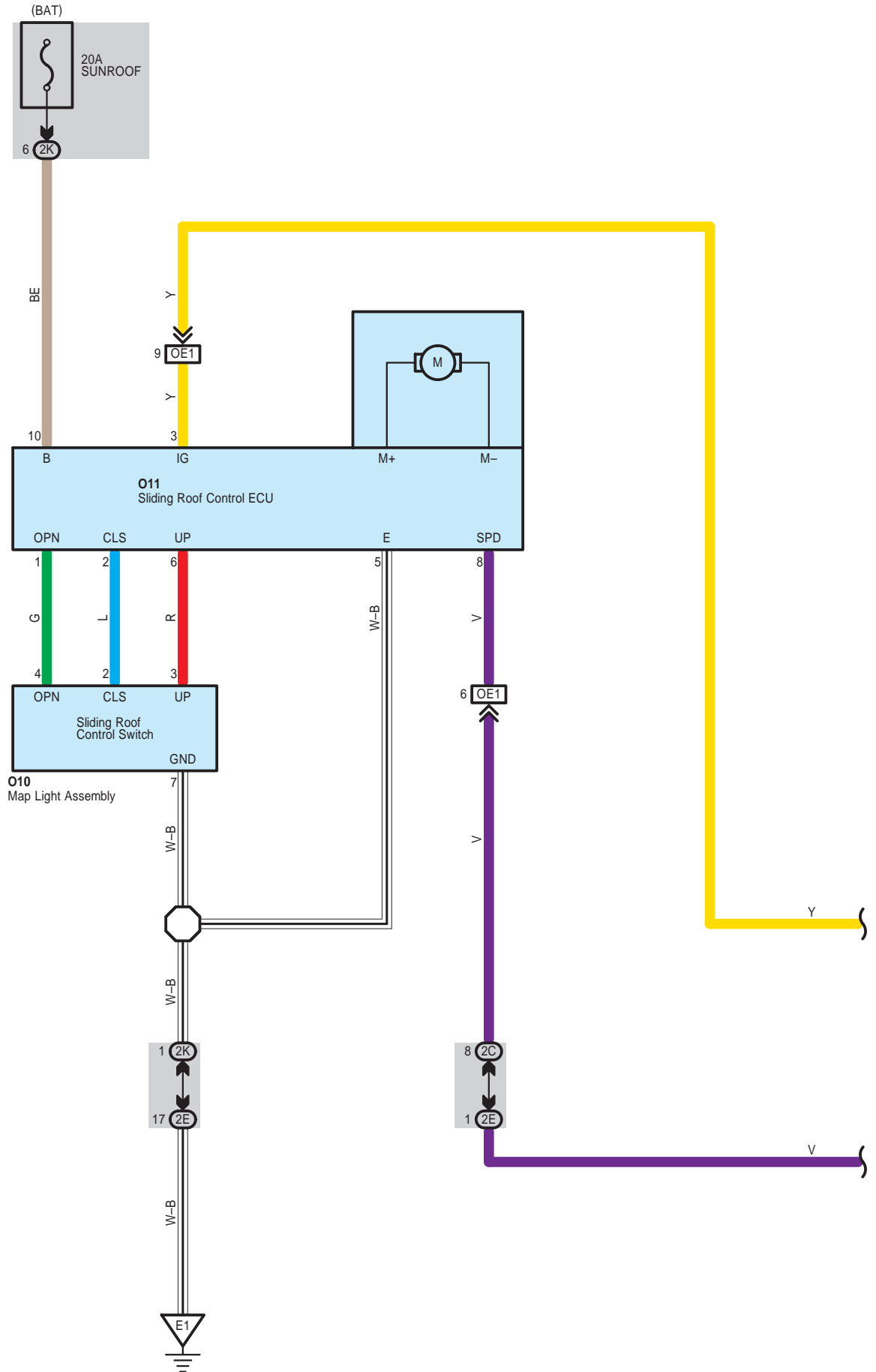

Sliding Roof <Except TMC Made>

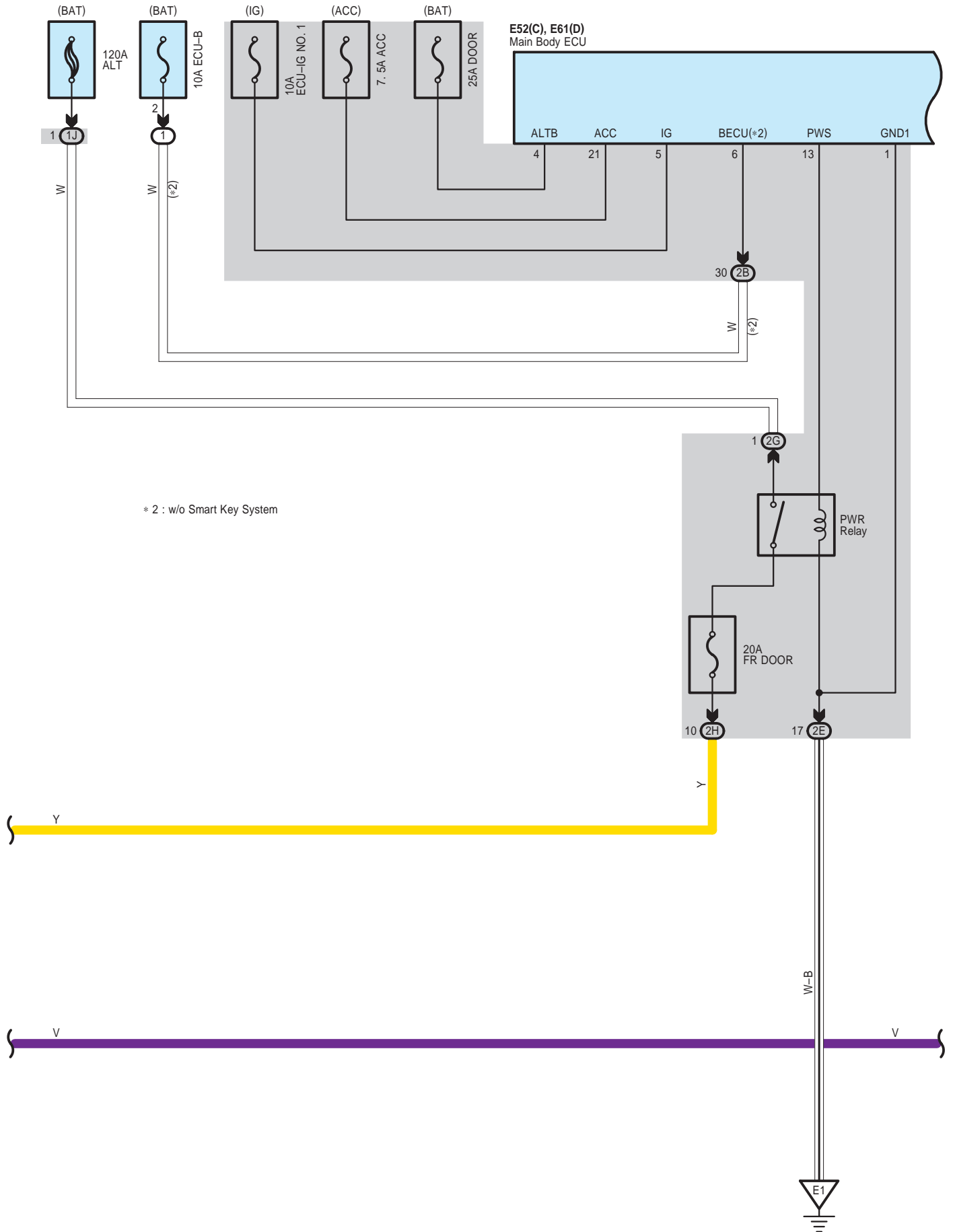

Sliding Roof <Except TMC Made>

\* 1 : w/ Smart Key System  
 \* 2 : w/o Smart Key System

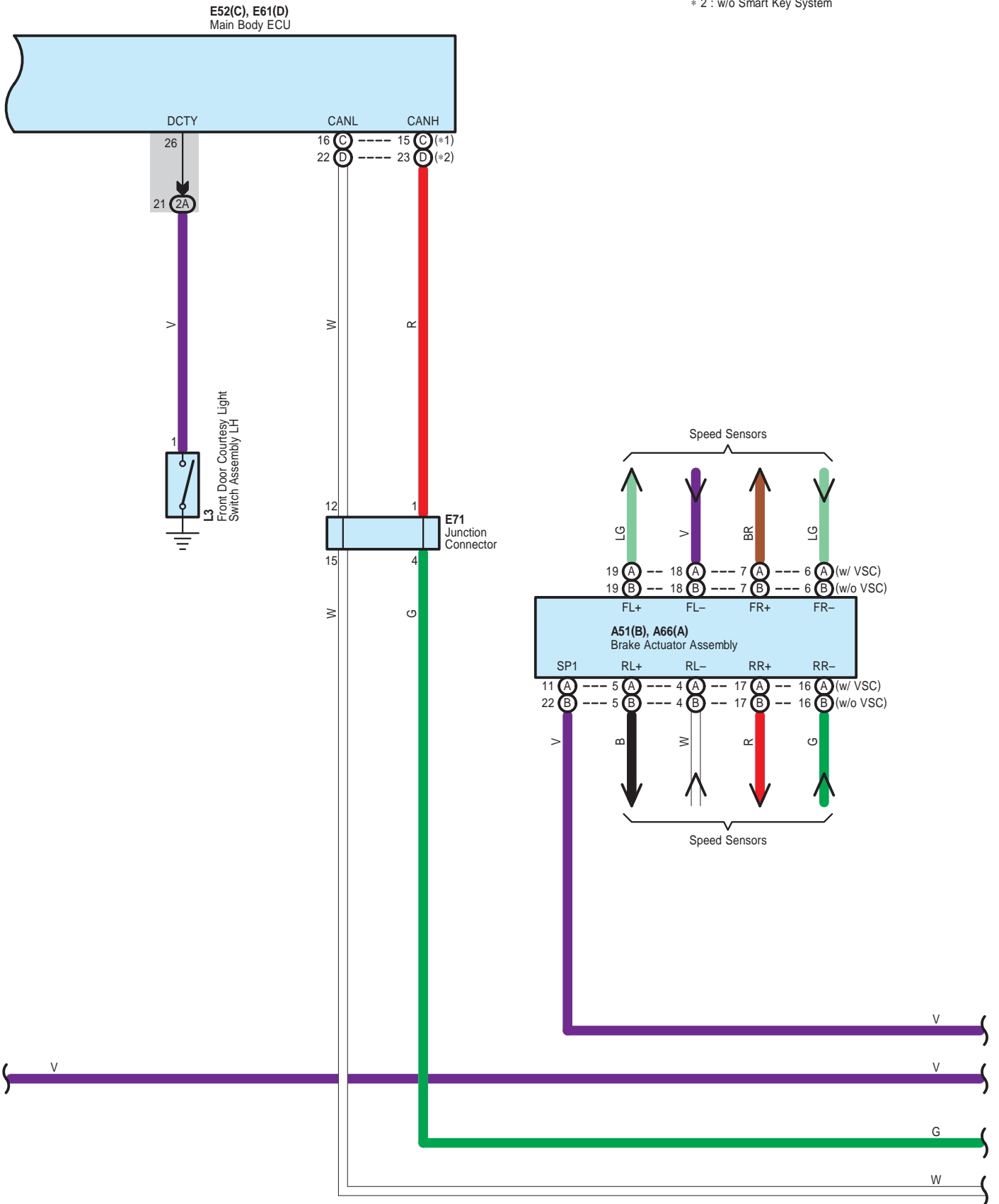

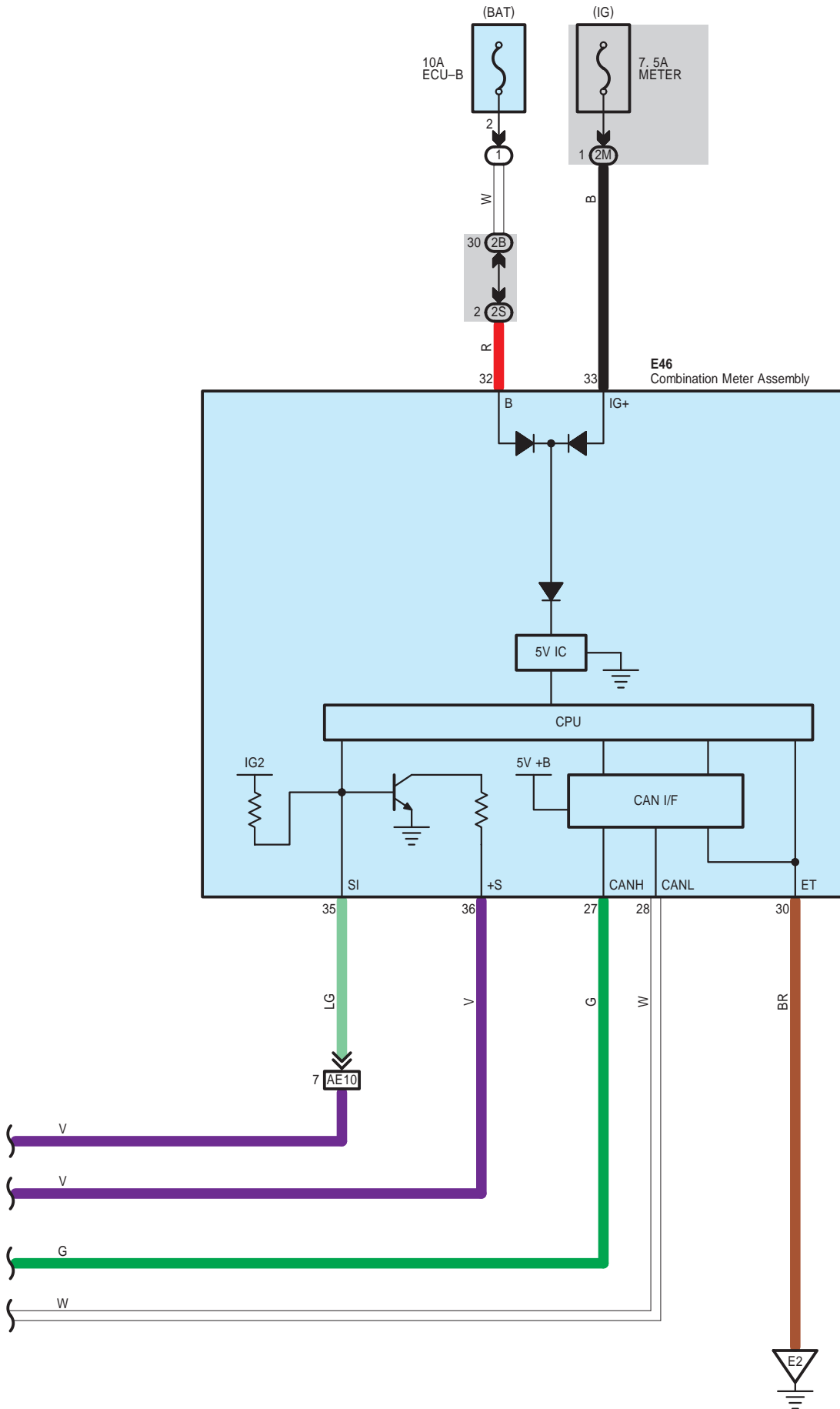

Sliding Roof <Except TMC Made>

A 51  
Gray

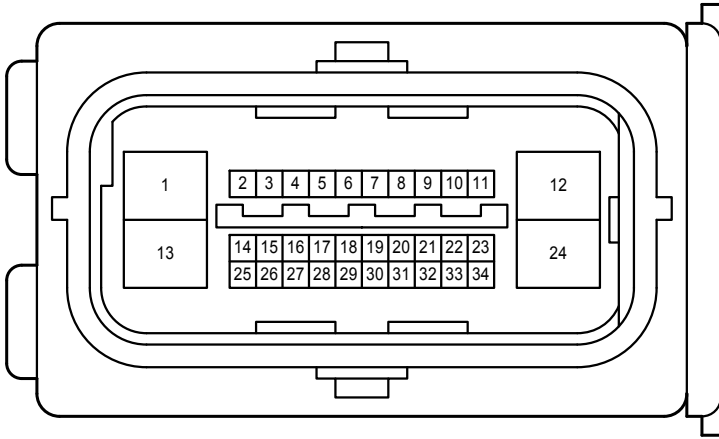

A 66  
Black

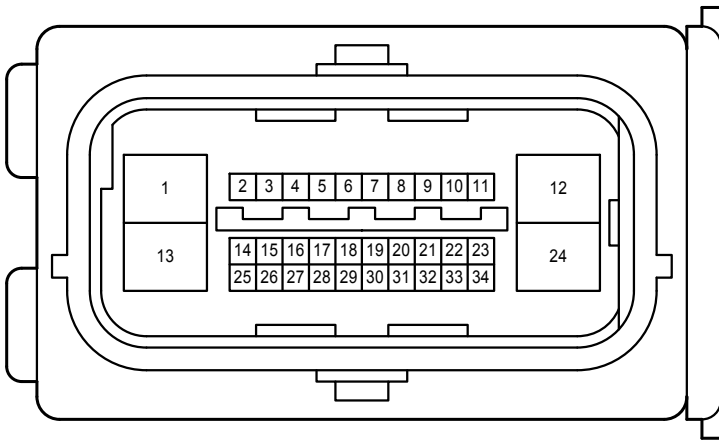

E 46  
White

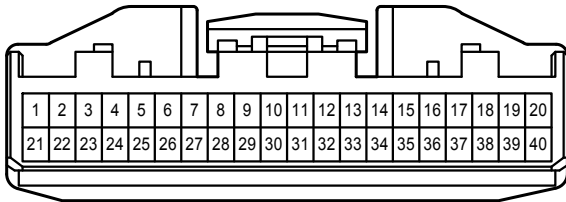

E 52  
White

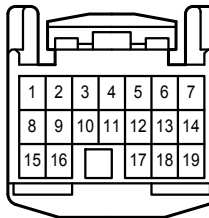

E 61  
White

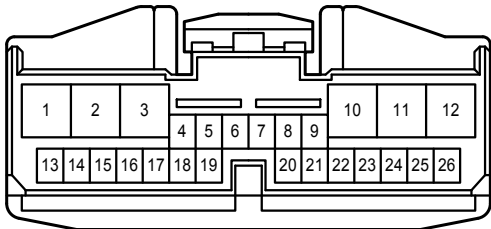

E 71  
White

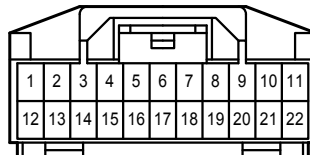

L 3  
Black



Sliding Roof <Except TMC Made>

O 10  
Black



O 11  
Gray

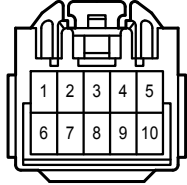

1J



2A  
White

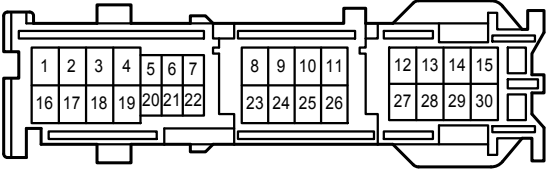

2B  
White

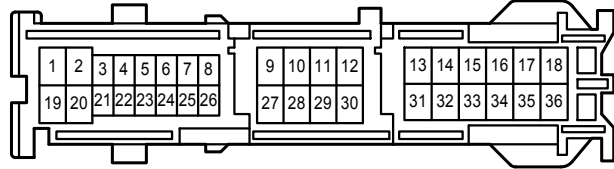

2C  
White

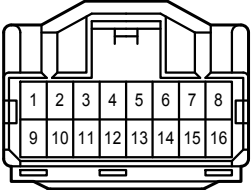

2E  
White

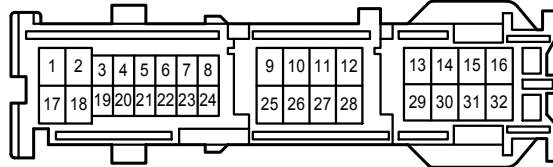

2G  
White

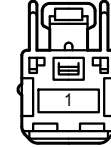

2H  
White

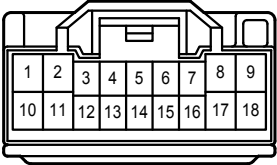

2K  
White

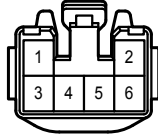

2M  
White

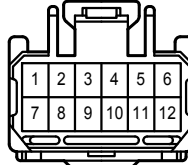

2S  
White

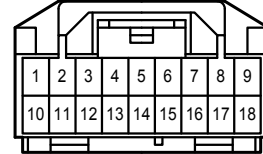

AE10  
Gray

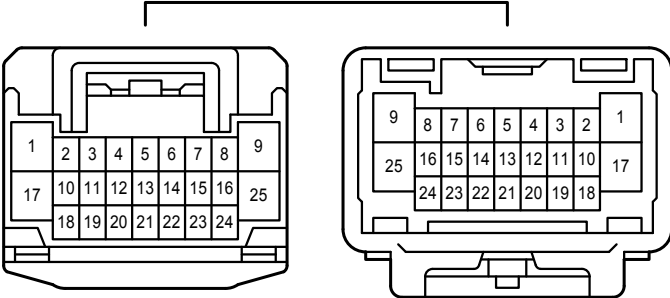

OE1  
White

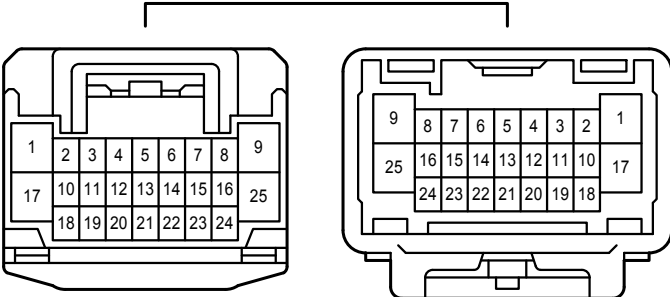

NOTICE : When inspecting or repairing the SRS, perform service in accordance with the following precautionary instructions and the procedure, and precautions in the Repair Manual applicable for the model year.

\* Malfunction symptoms of the SRS are difficult to confirm, so the DTCs become the most important source of information when troubleshooting. When troubleshooting the SRS, always inspect the DTCs before disconnecting the battery.

\* **Work must be started more than 90 seconds after the ignition or starter switch assembly is turned to the " LOCK" position (Ignition switch type) or the engine switch is pushed to the " OFF" position (Engine switch type) and the negative (-) terminal cable is disconnected from the battery.**

**(The SRS is equipped with a back-up power source so that if work is started within 90 seconds from disconnecting the negative (-) terminal cable of the battery, the SRS may deploy.)**

\* When the negative (-) terminal cable is disconnected from the battery, the memory of the clock and audio system will be cleared. So before starting work, make a record of the contents in the audio memory system. When work is finished, reset the audio systems as they were before and adjust the clock. Some vehicles have power tilt steering, power telescopic steering, power seat and power outside rear view mirror which are all equipped with memory function. However, it is not possible to make a record of these memory contents. So when the work is finished, it will be necessary to explain it to your customer, and ask the customer to adjust the features and reset the memory. To avoid erasing the memory in each system, never use a back-up power supply from outside the vehicle.

\* Before repair, remove the airbag sensor if shocks are likely to be applied to the sensor during repair.

\* Do not expose the following parts directly to hot air or flame;

\* Even in cases of a minor collision where the SRS does not deploy, the following parts should be inspected;

\* Never use SRS parts from another vehicle. When replacing parts, replace with new parts.

\* For the purpose of reuse, never disassemble and repair the following parts.

\* If the following parts have been dropped, or have cracks, dents and other defects in their case, bracket, and connector replace with new one.

\* Use a volt/ohmmeter with high impedance (10 k  $\Omega$  / minimum) for troubleshooting electrical circuits of the system.

\* Information labels are attached to the periphery of the SRS components. Follow the instructions of the notice.

\* After work on the SRS is completed, check the SRS warning light.

\* If the vehicle is equipped with a mobile communication system, refer to the precaution in the IN section of the Repair Manual.

- \* Steering wheel pad
- \* Front passenger airbag assembly
- \* Side airbag assembly
- \* Curtain shield airbag assembly
- \* Seat belt pretensioner
- \* Center airbag sensor assembly
- \* Front airbag sensor assembly
- \* Side airbag sensor assembly
- \* Rear airbag sensor assembly

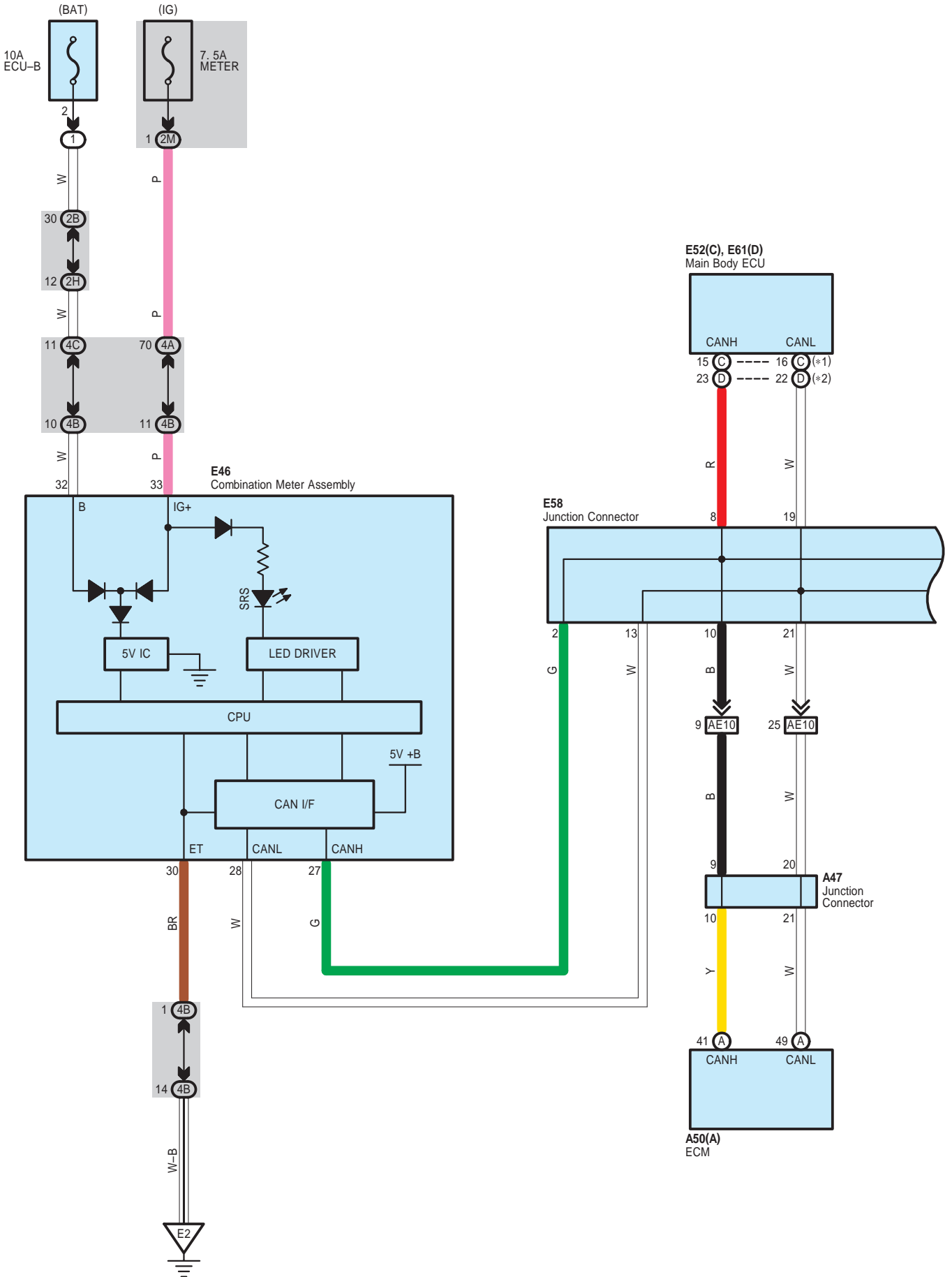



- \* 1 : w/ Smart Key System
- \* 2 : w/o Smart Key System

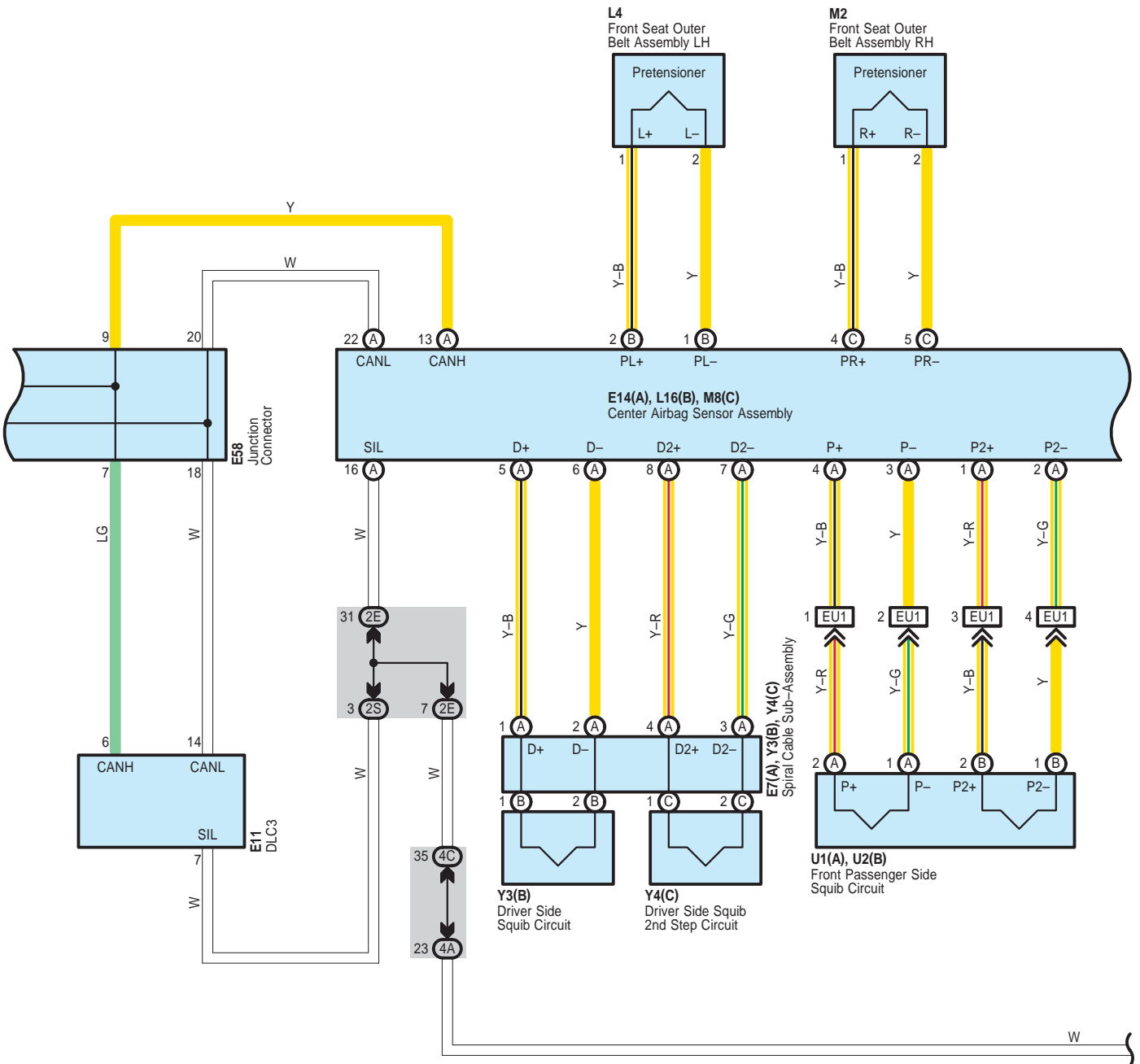

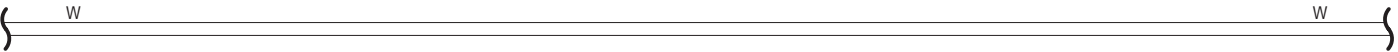
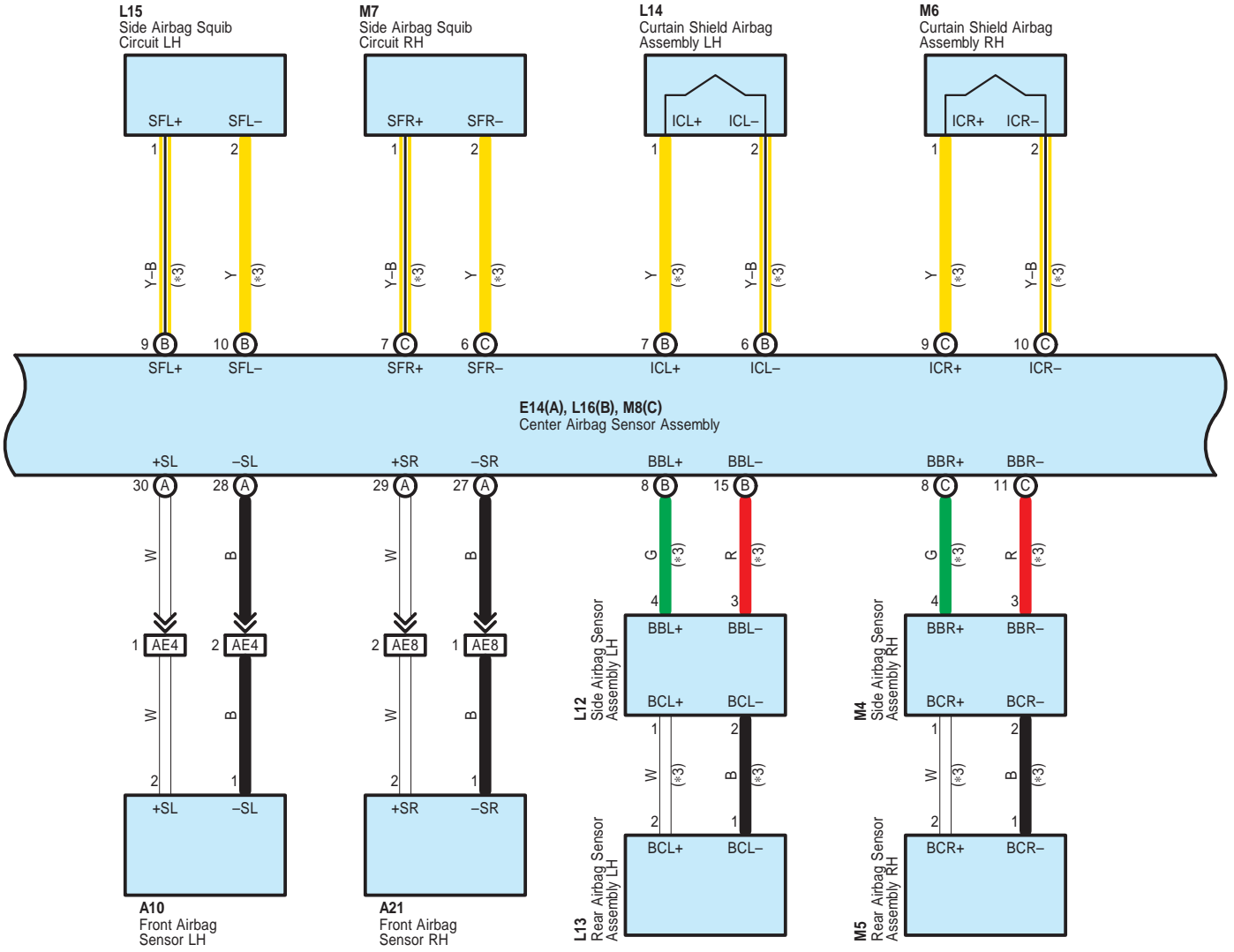

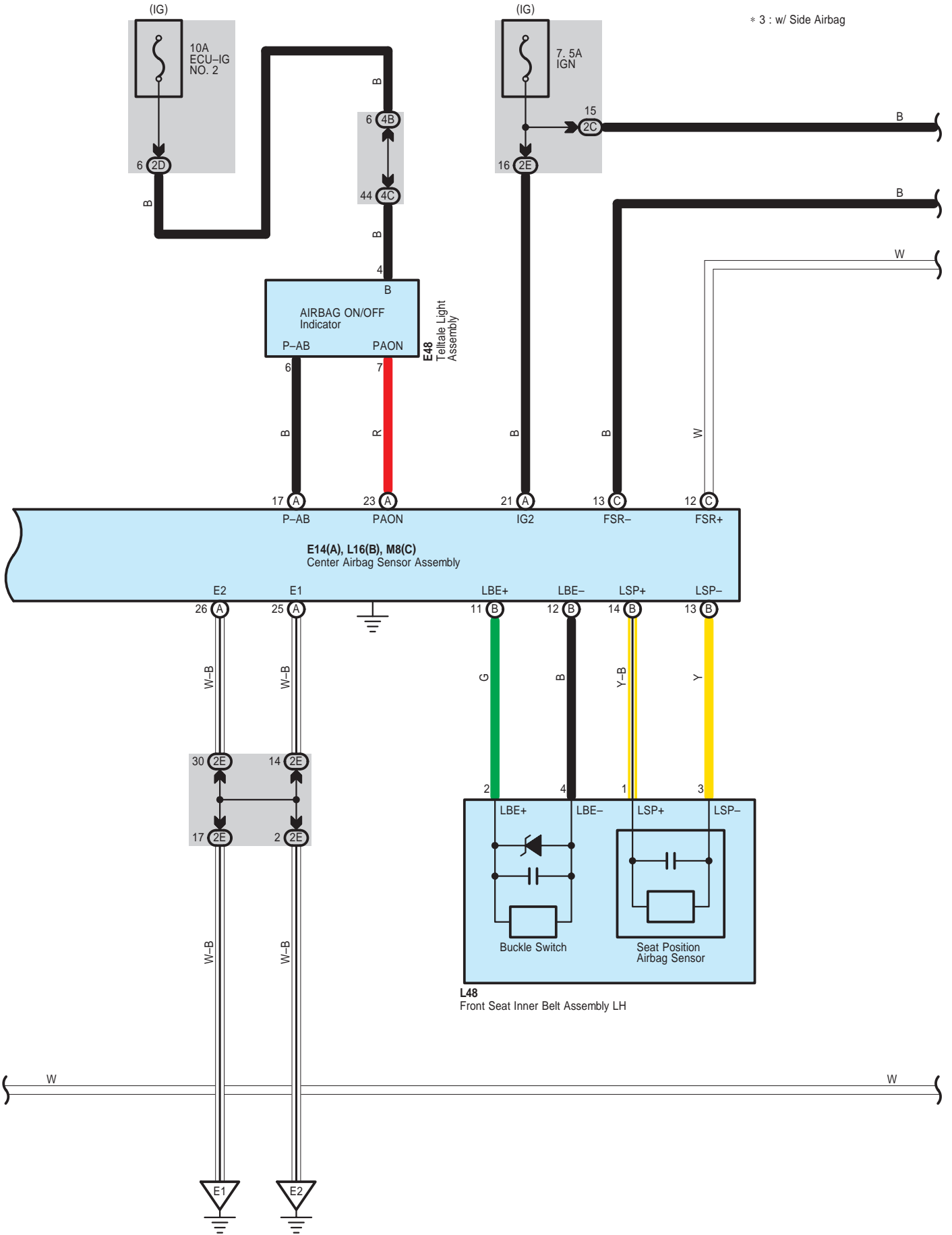

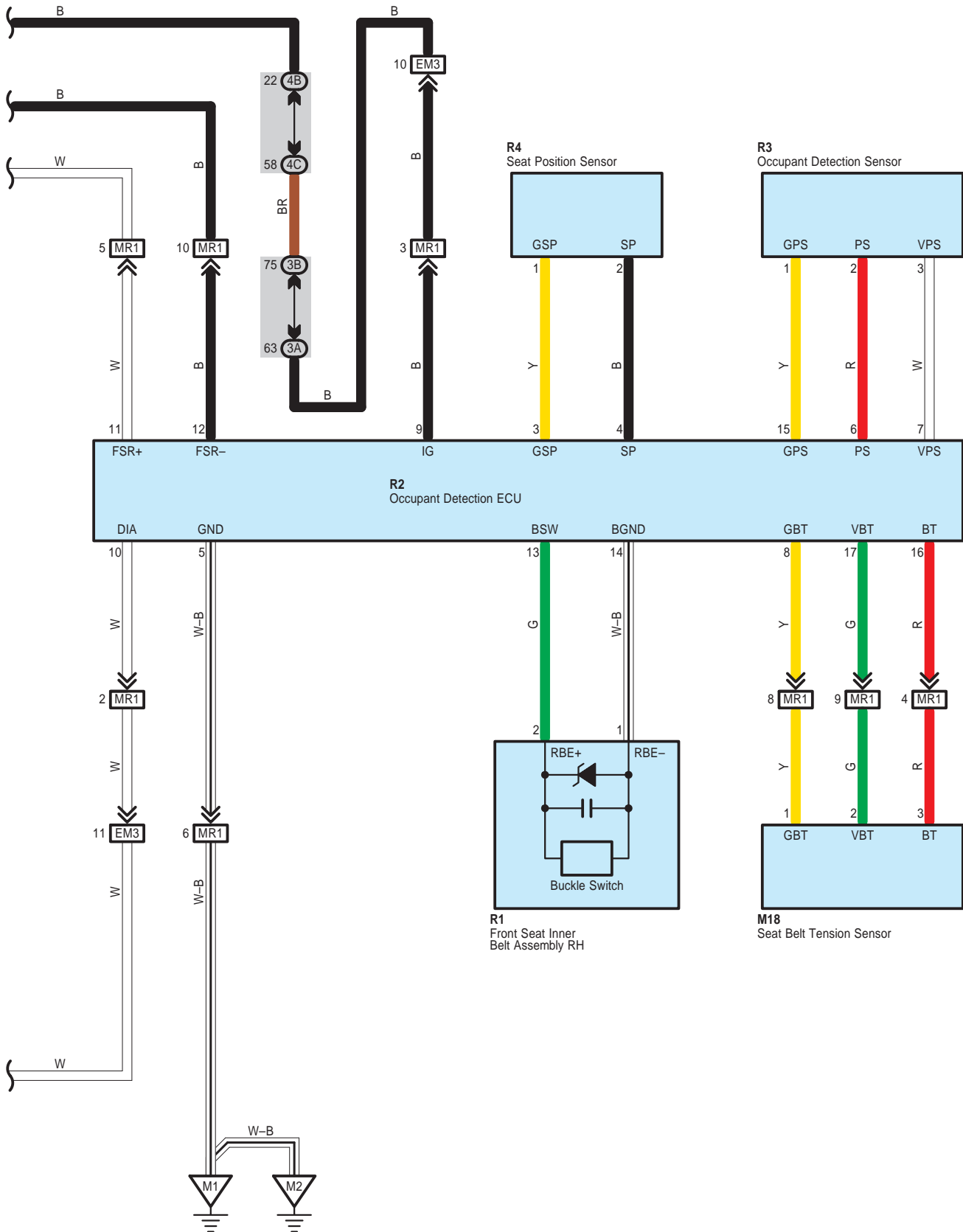

A 10  
Yellow

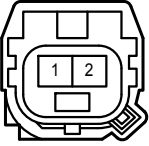

A 21  
Yellow

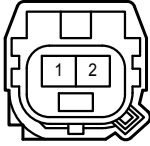

A 47  
White

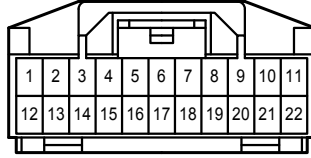

A 50  
Black

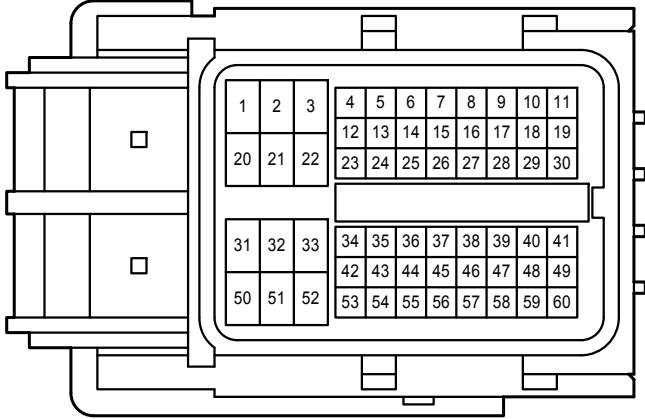

E 7  
Yellow

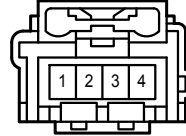

E 11  
White

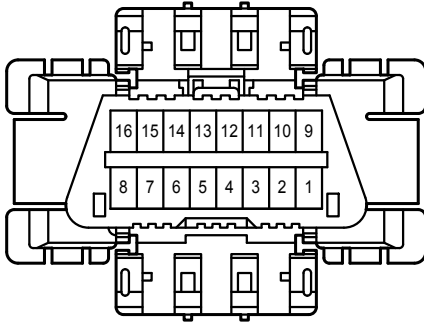

E 14  
Yellow

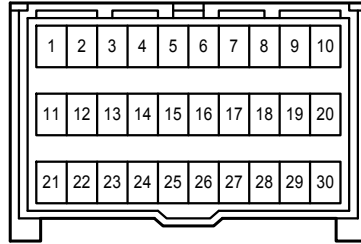

E 46  
White

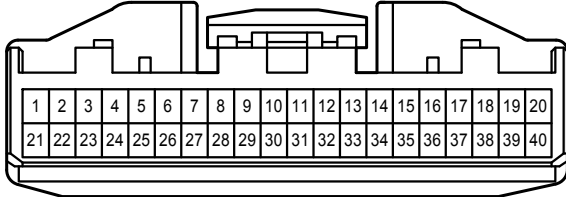

E 48  
Black

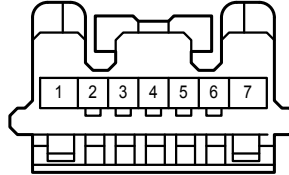

E 52  
White

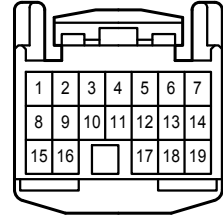

E 58  
Gray

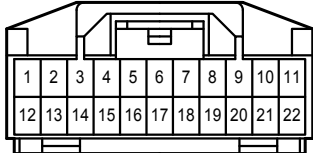

E 61  
White

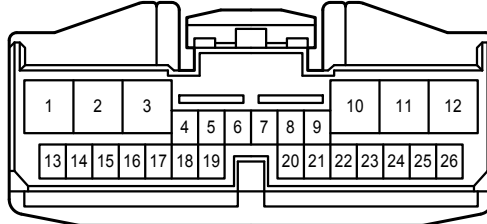

L 4  
Black

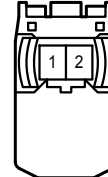

L 12  
Yellow

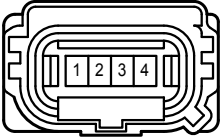

L 13  
Yellow

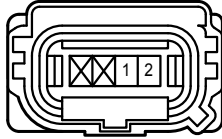

L 14  
Black

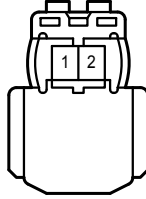

L 15  
Yellow

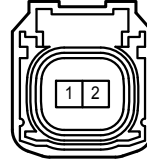

L 16  
Yellow

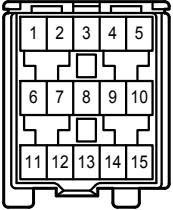

L 48  
White



M 2  
Black

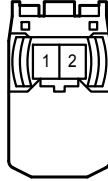

M 4  
Yellow

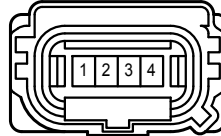

M 5  
Yellow

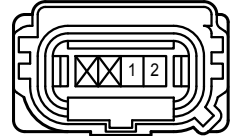

M 6  
Black

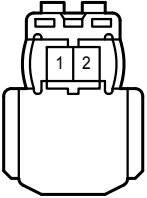

M 7  
Yellow

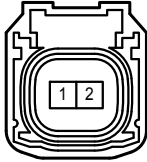

M 8  
Yellow

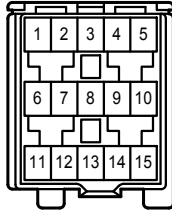

M 18  
White

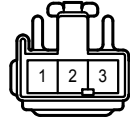

R 1  
White

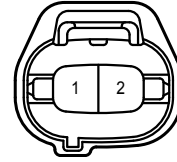

R 2  
Black

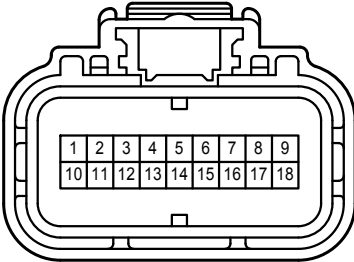

R 3  
Gray

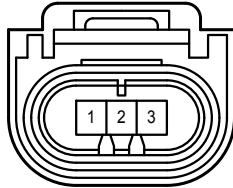

R 4  
Black

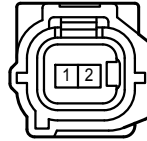

U 1  
Orange

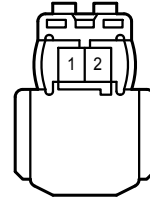

U 2  
Black

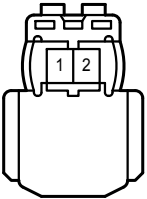

Y 3  
Orange

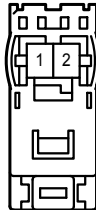

Y 4  
Black

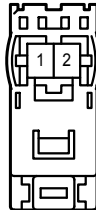

2B  
White

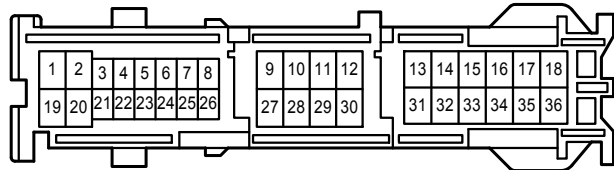

2C  
White

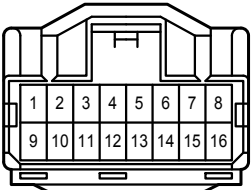

2D  
White

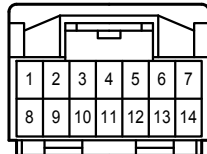

2E  
White

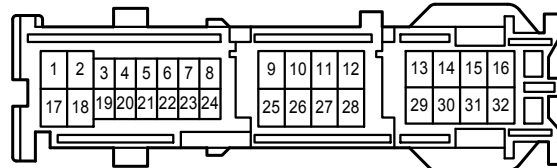

2H

White

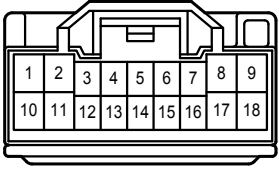

2M

White

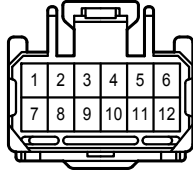

2S

White

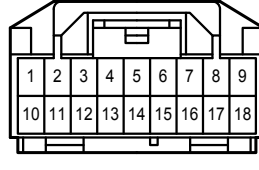

3A

White

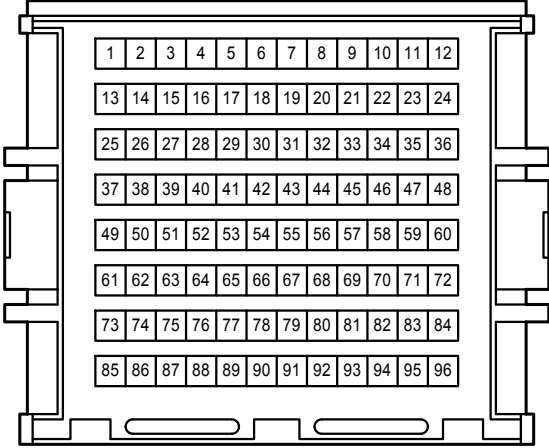

3B

White

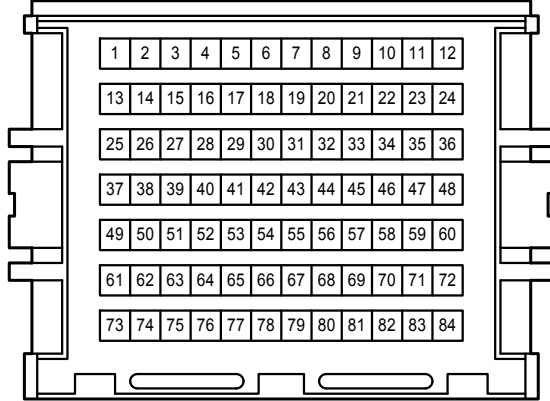

4A

White

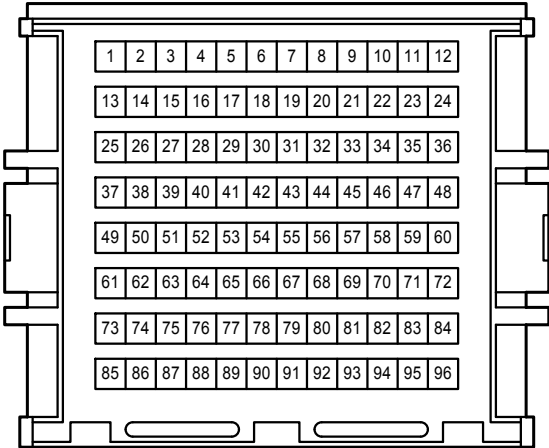

4B

White

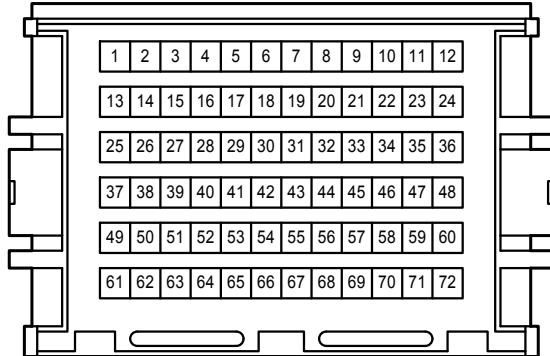

4C

White

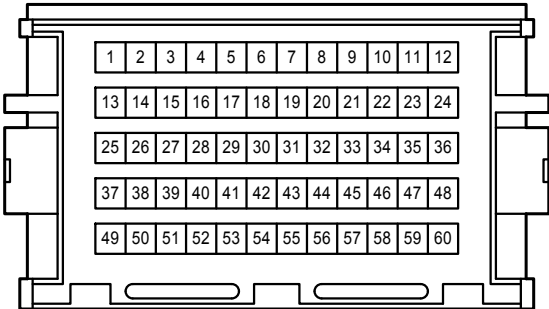

AE4

Yellow

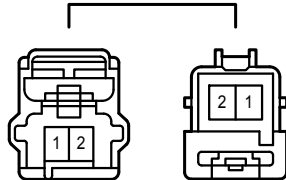

AE8  
Yellow

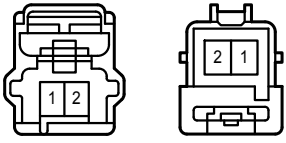

AE10  
Gray

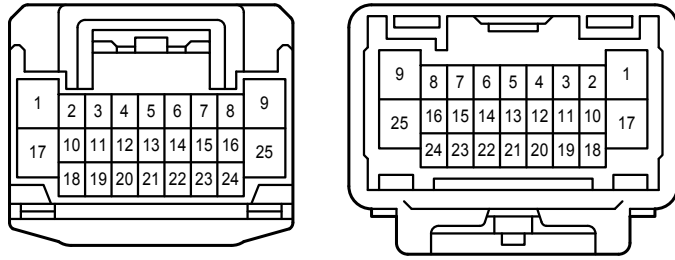

EM3  
White

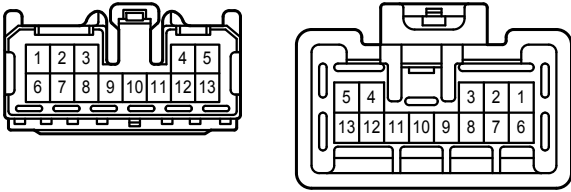

EU1  
Yellow

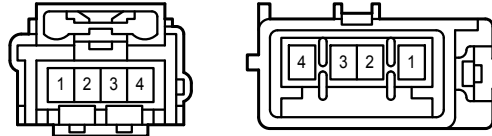

MR1  
Black

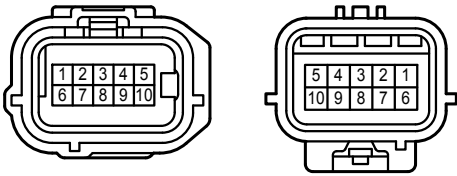



Starting <w/o Smart Key System , Except TMC Made>

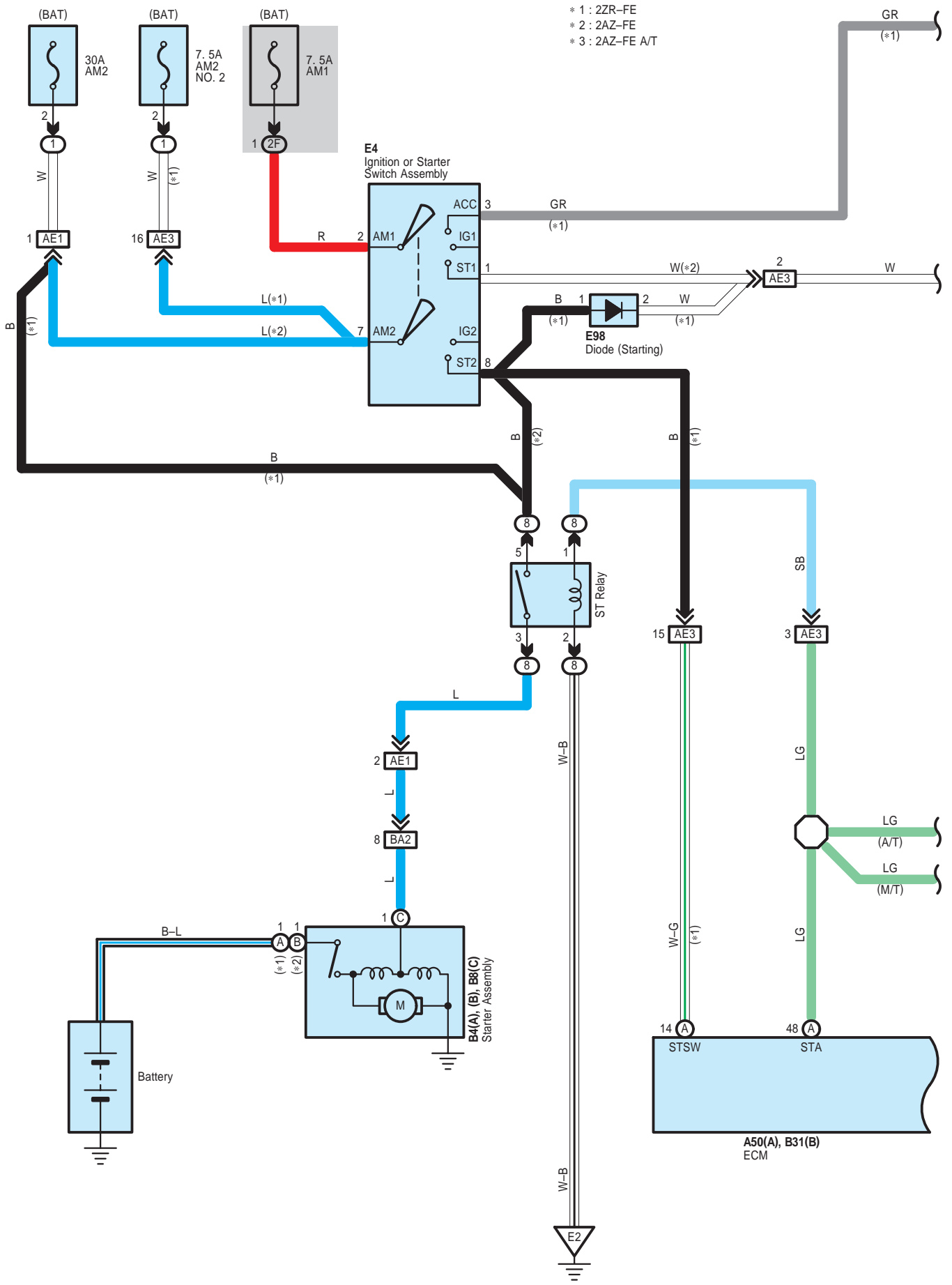

Starting <w/o Smart Key System , Except TMC Made>

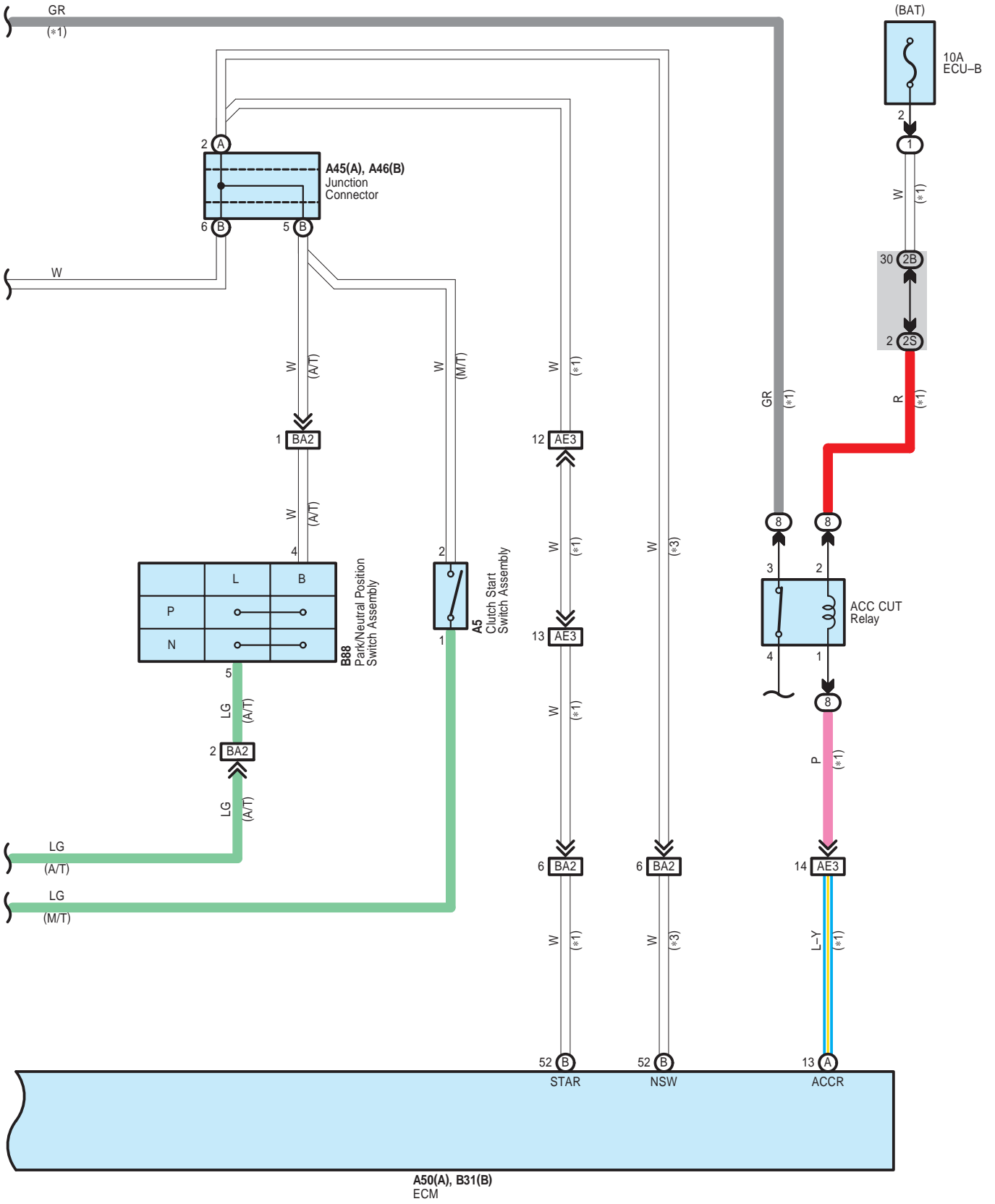



AE1  
White

AE3  
White

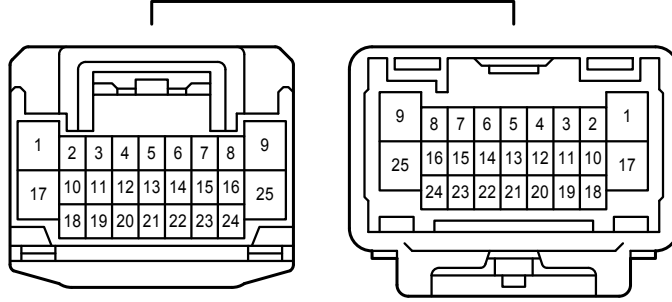
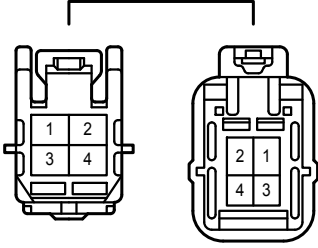

BA2  
White

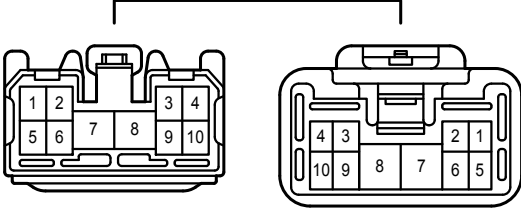

Starting <w/o Smart Key System , TMC Made>

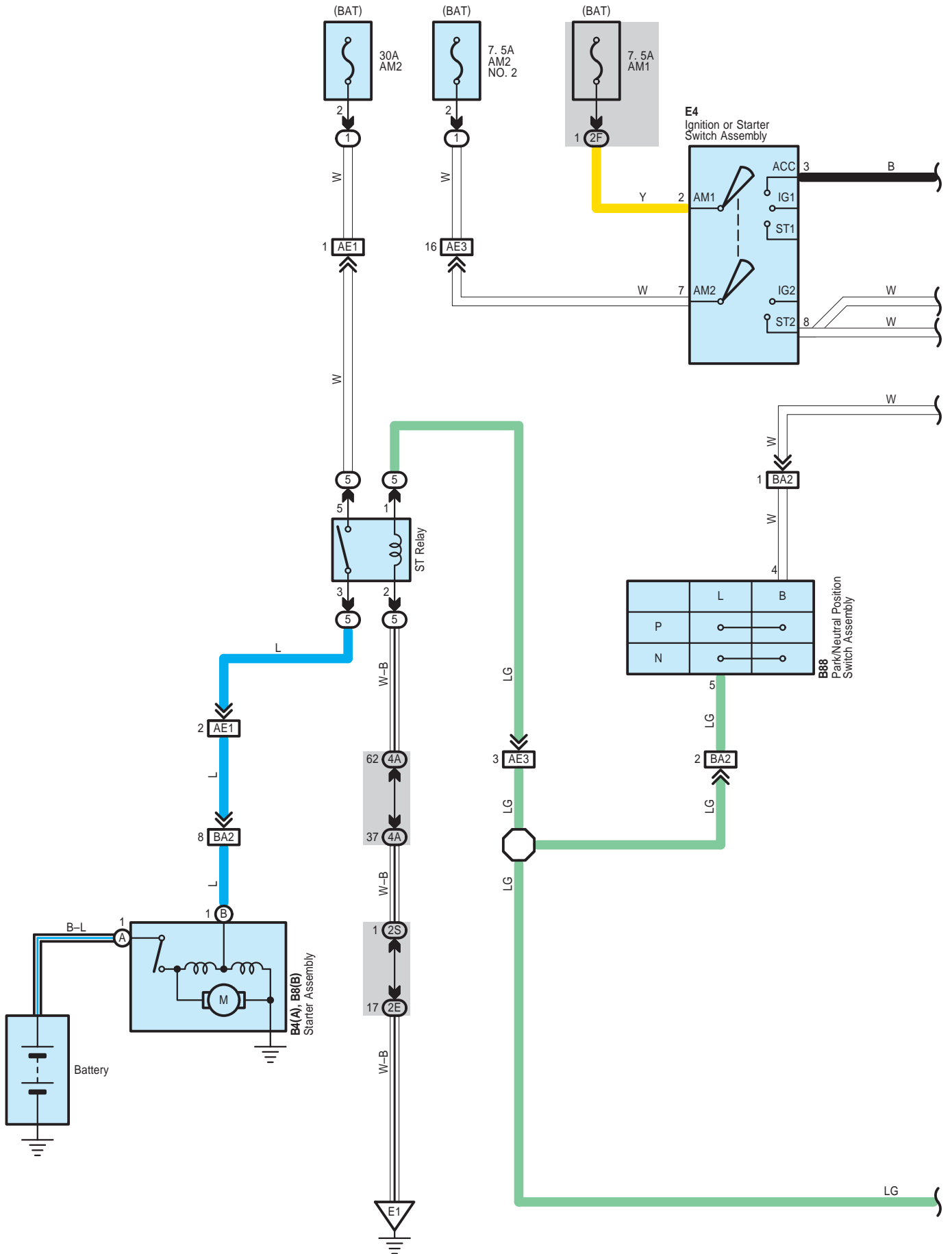

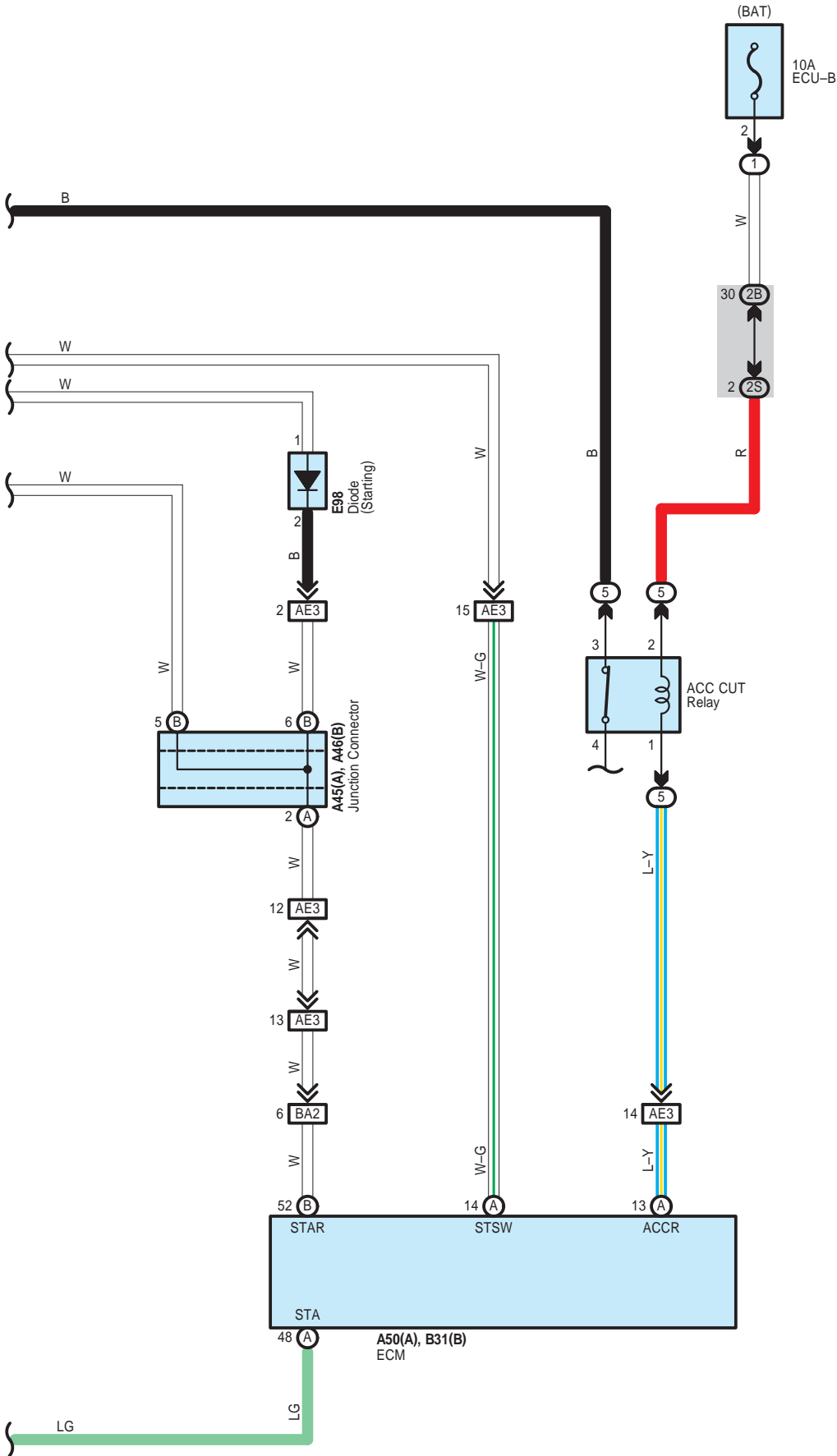



2F

White

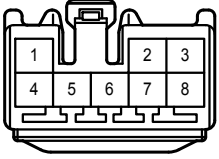

2S

White

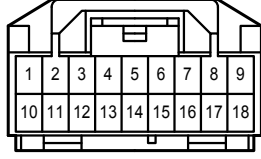

4A

White

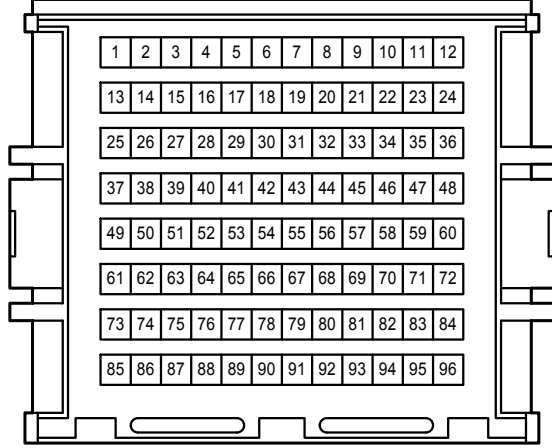

AE1

White

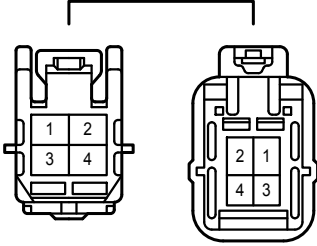

AE3

White

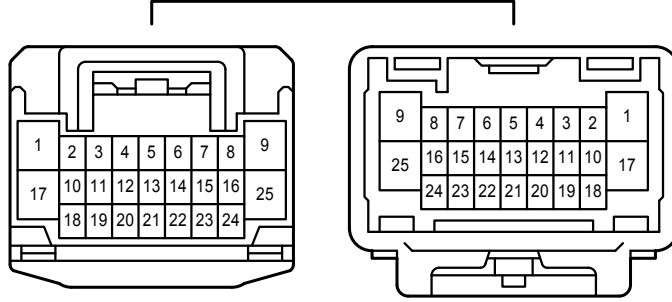

BA2

White

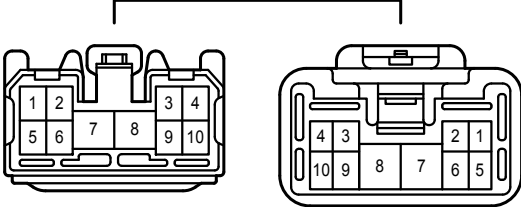



Stop Light <Except TMC Made>

\* 1 : w/ Rear Spoiler  
 \* 2 : w/o Rear Spoiler

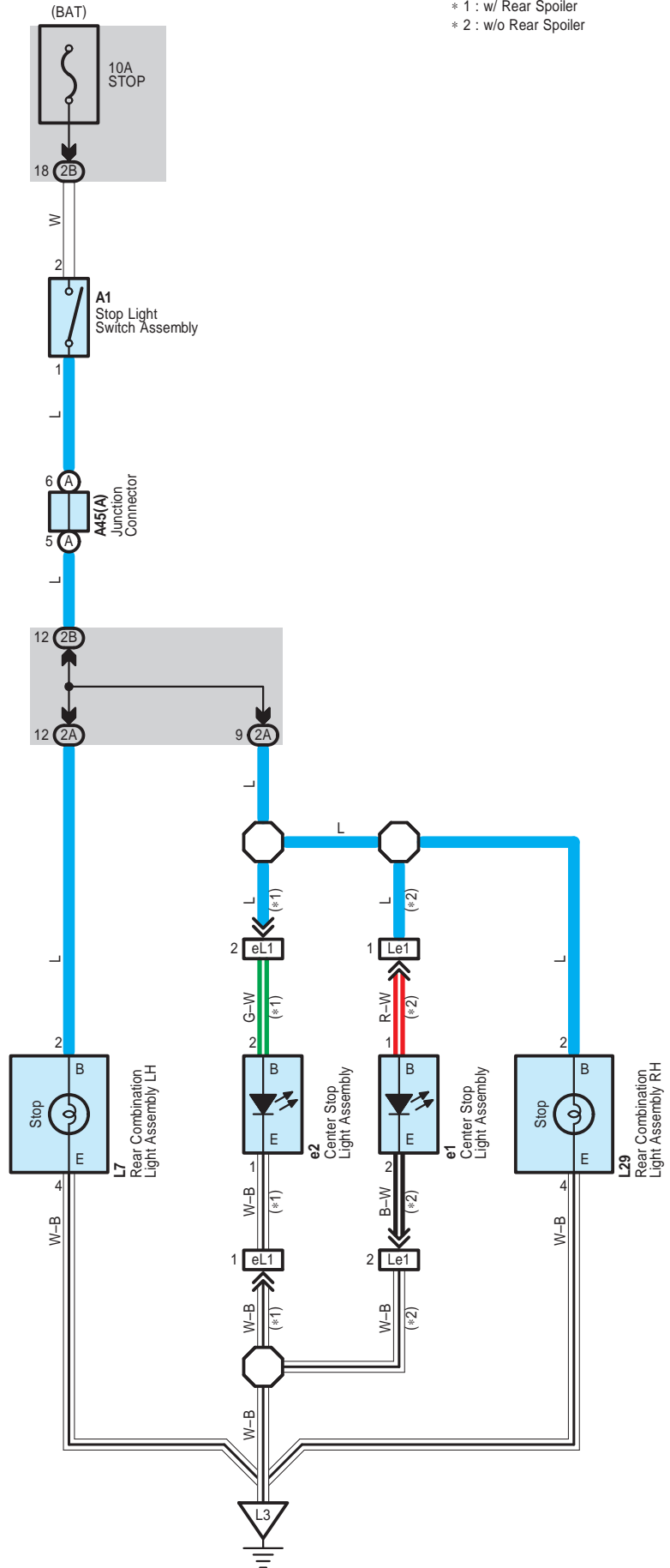

Stop Light <Except TMC Made>

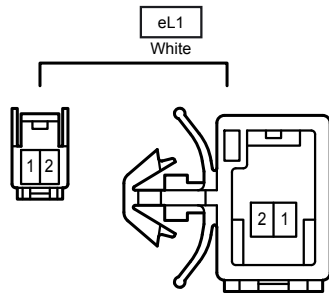
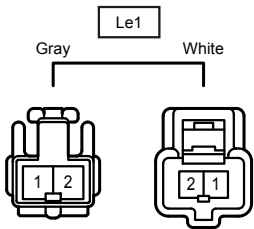
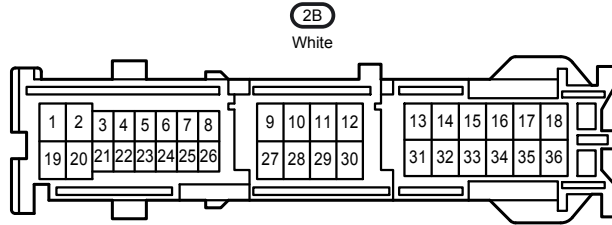
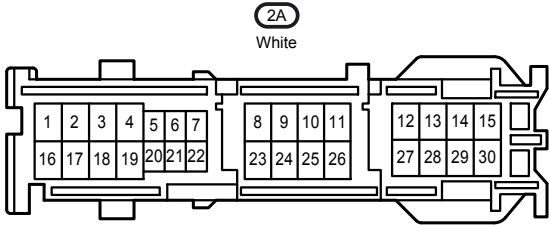
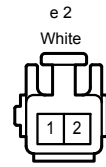
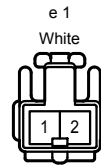
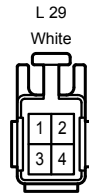
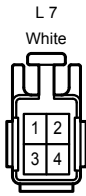
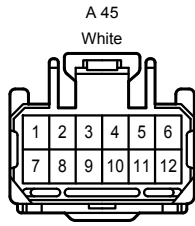
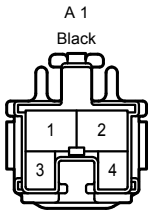

Stop Light <TMC Made>

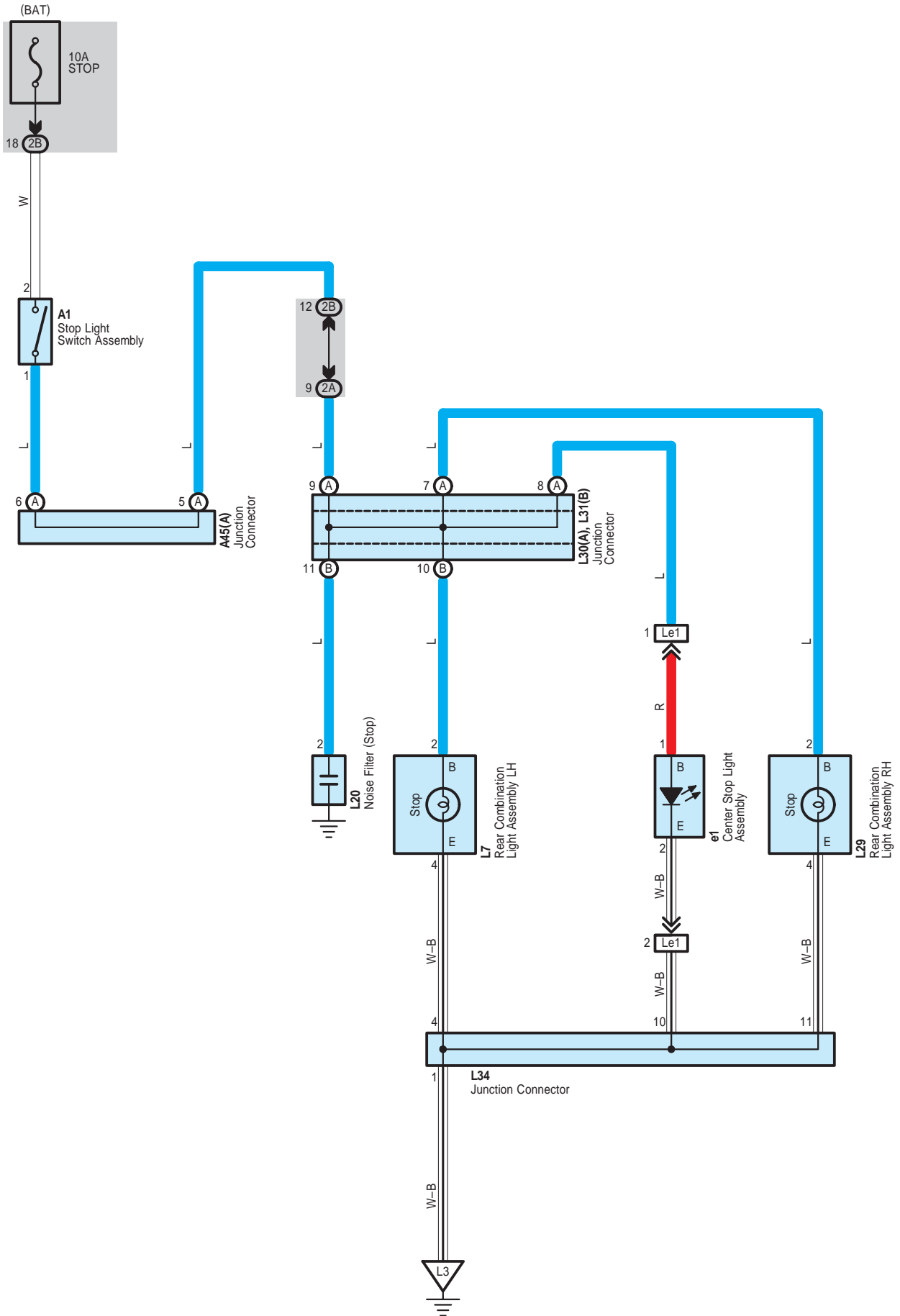

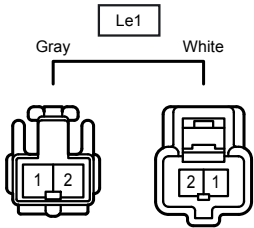
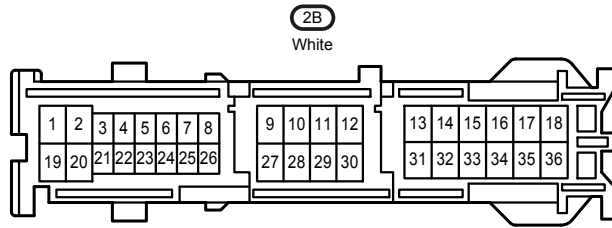
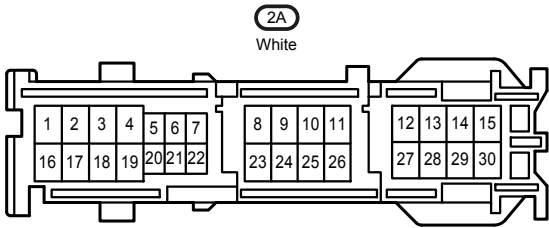
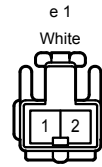
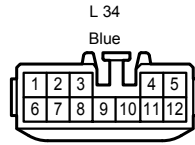
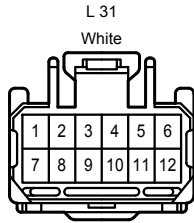
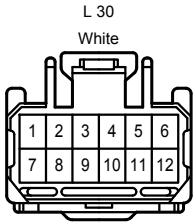
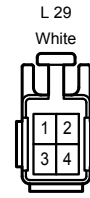
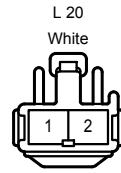
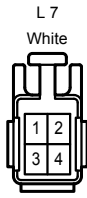
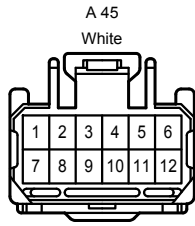
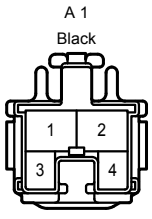

Theft Deterrent <Except TMC Made>

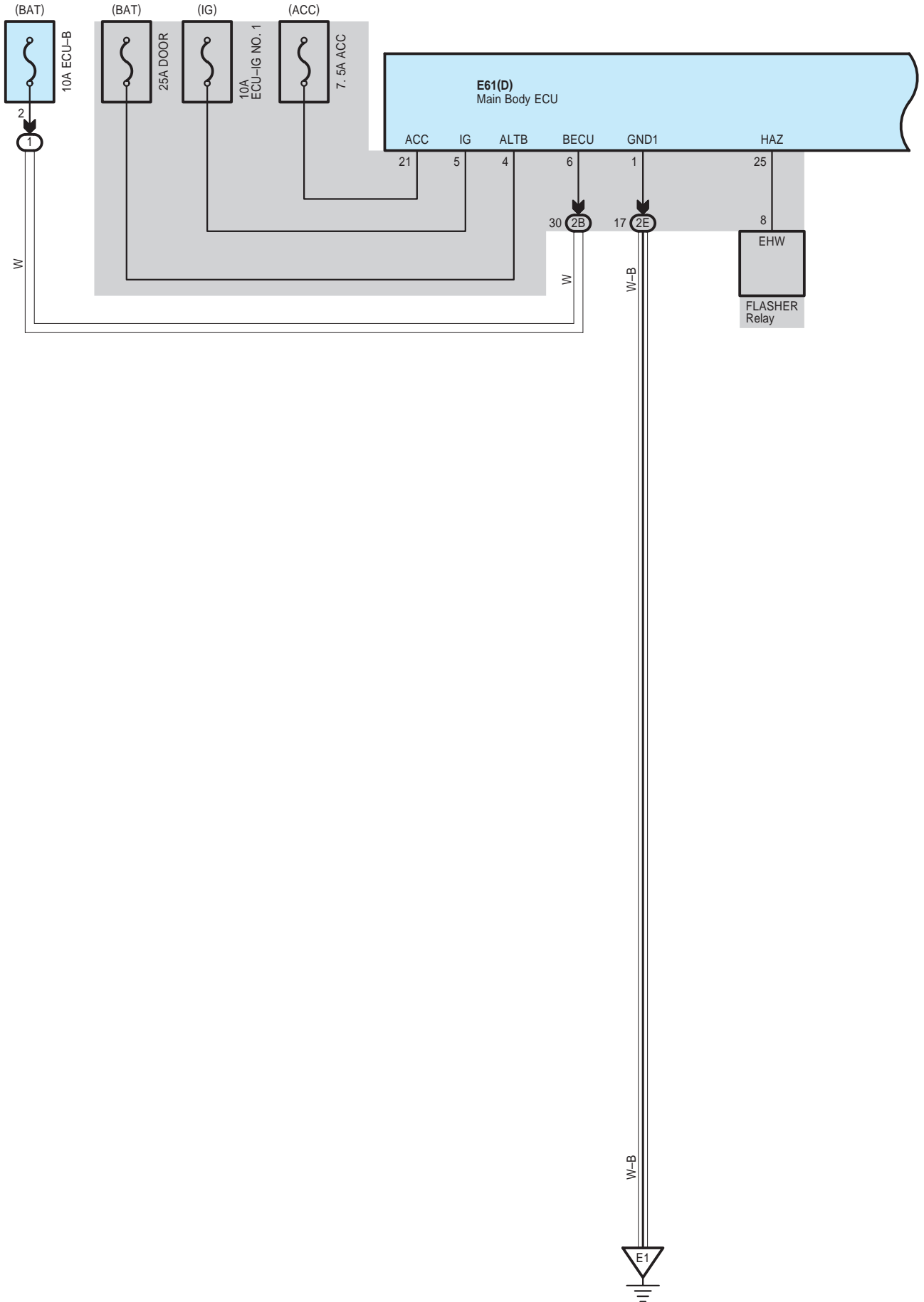

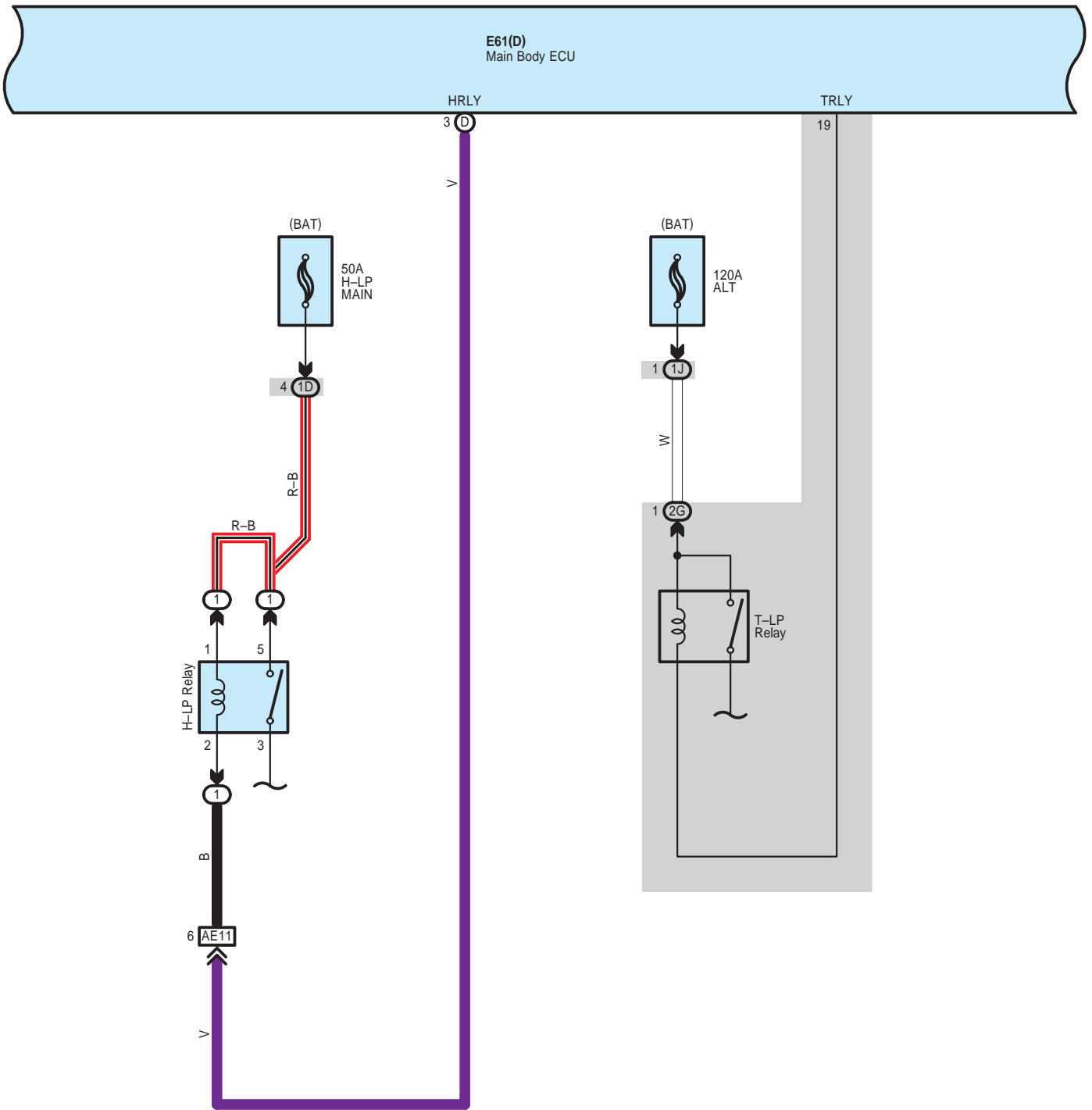

\* 1 : w/ Sliding Roof

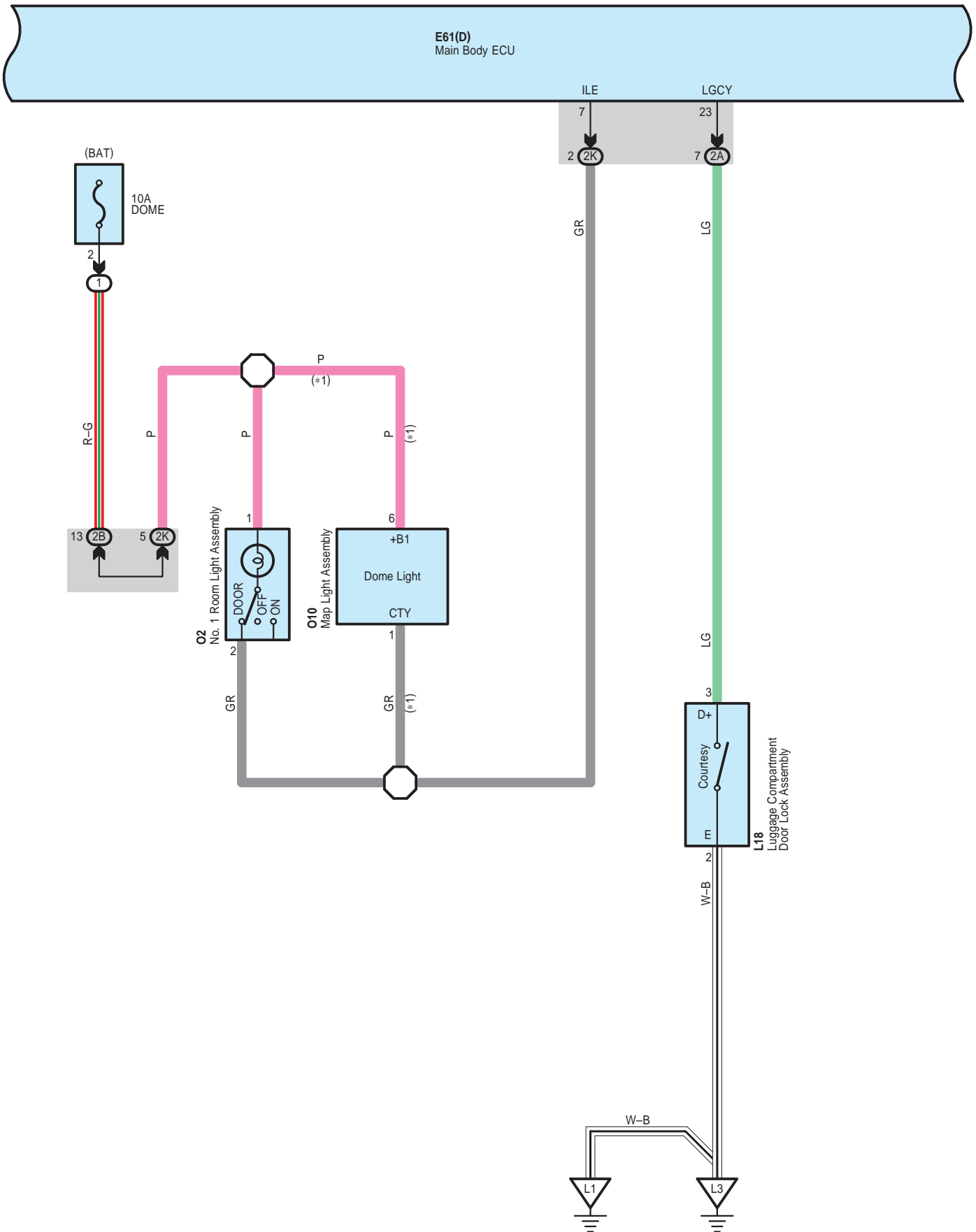

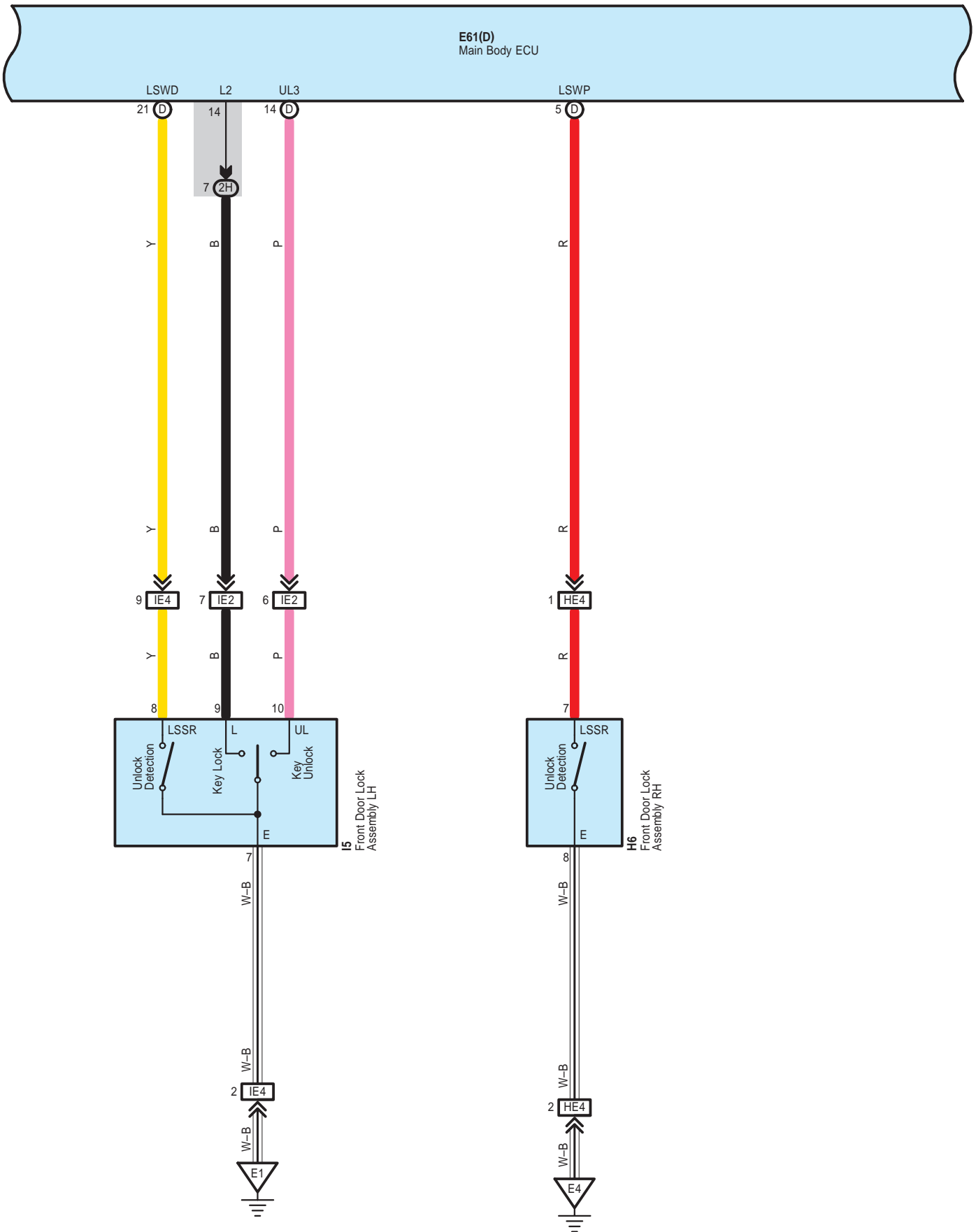



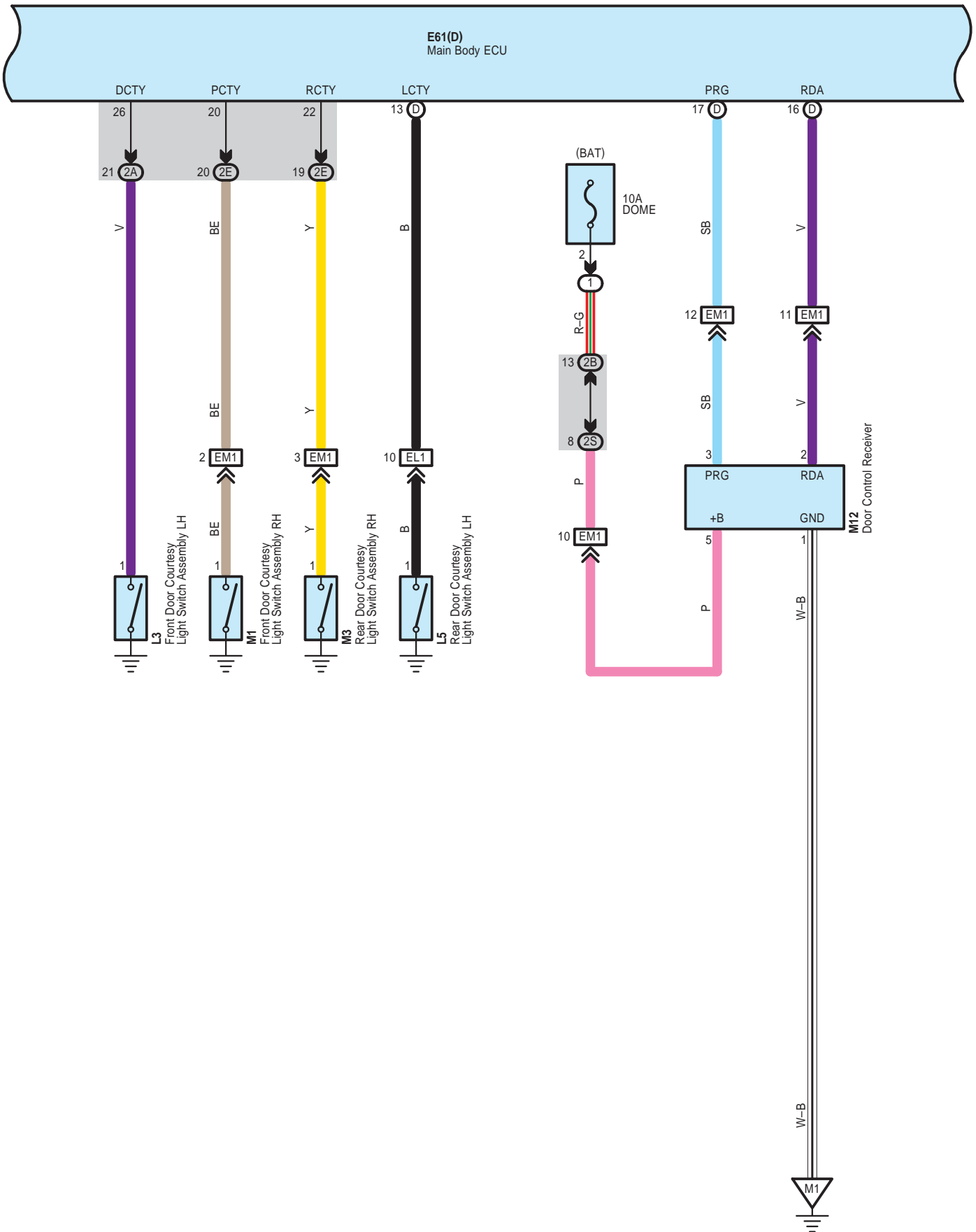

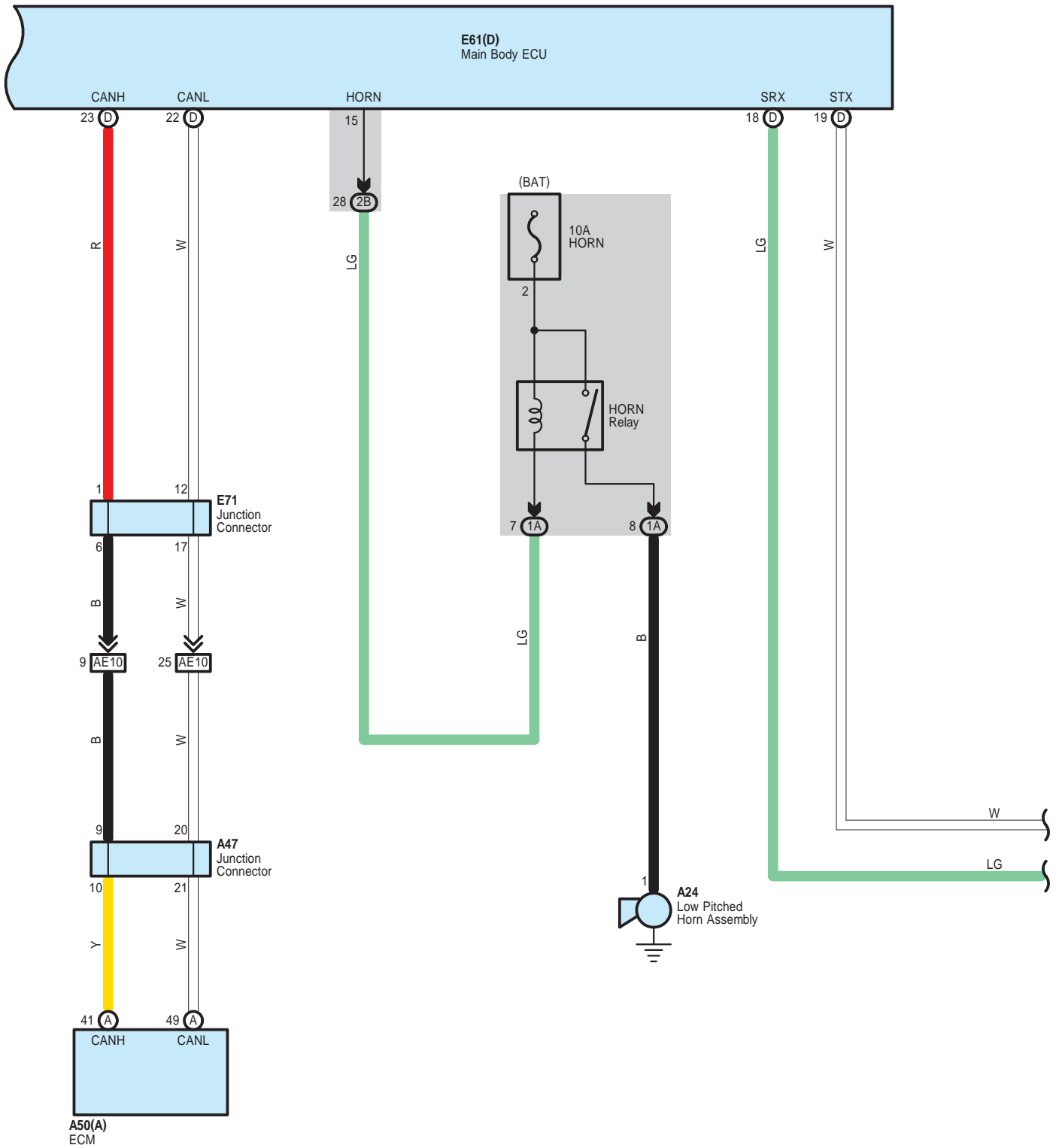

Thrift Deterrent <Except TMC Made>

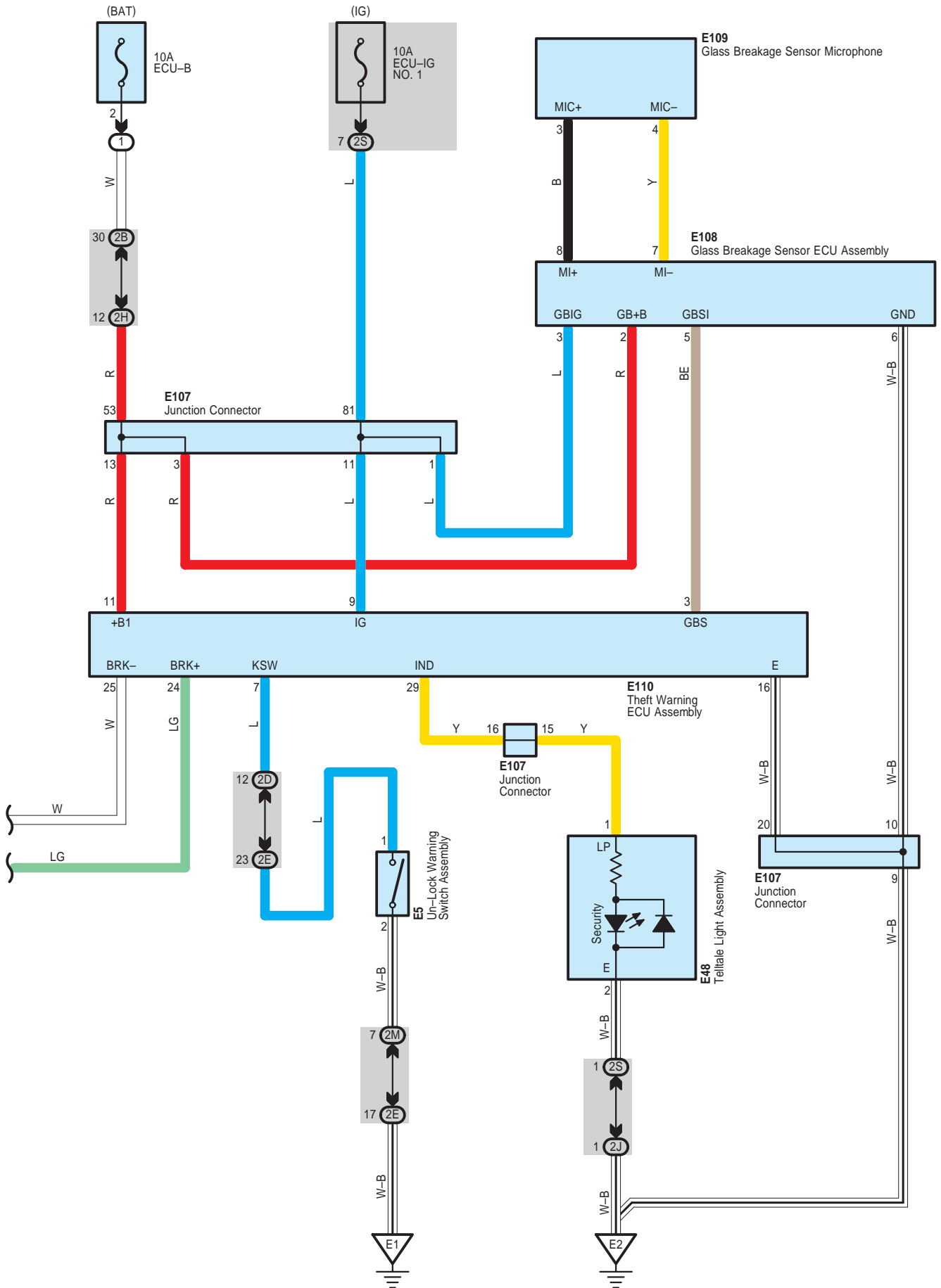

Theft Deterrent <Except TMC Made>

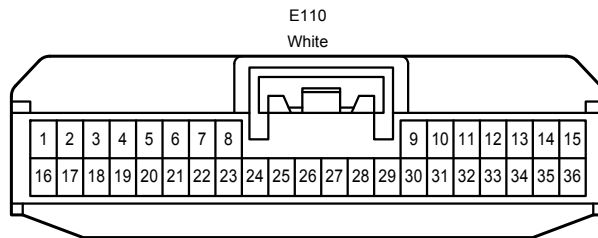
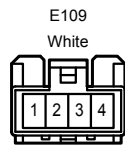
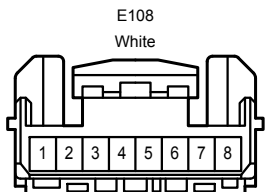
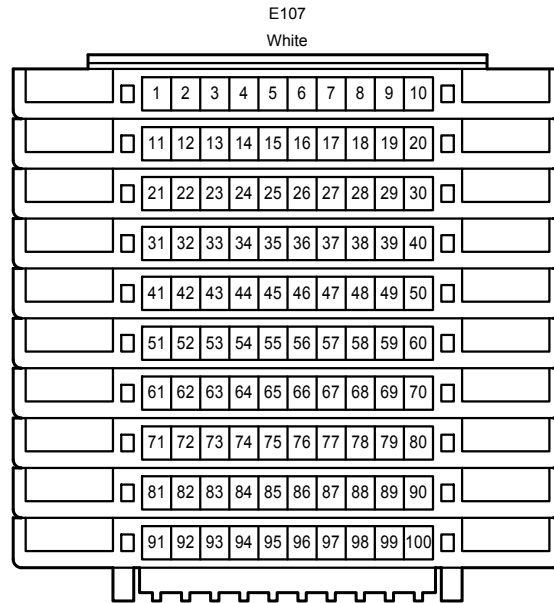
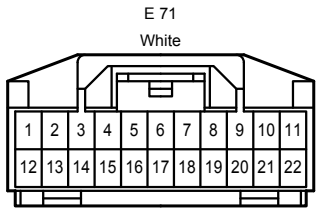
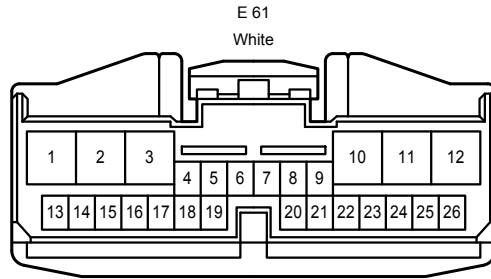
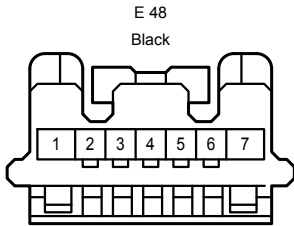
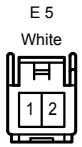
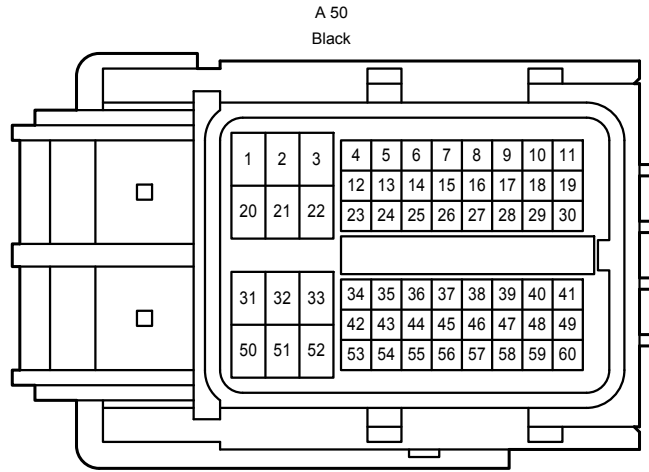
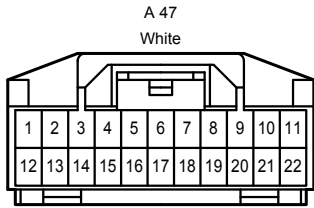
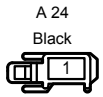

Theft Deterrent <Except TMC Made>

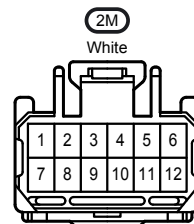
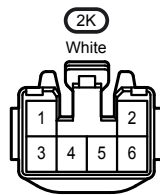
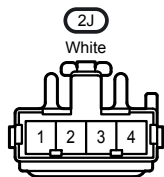
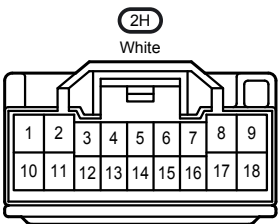
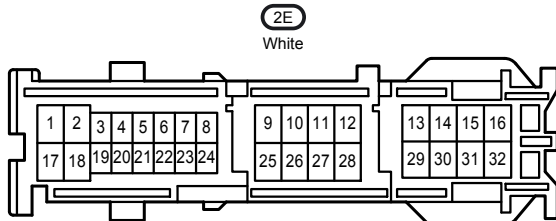
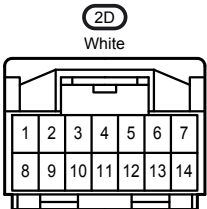
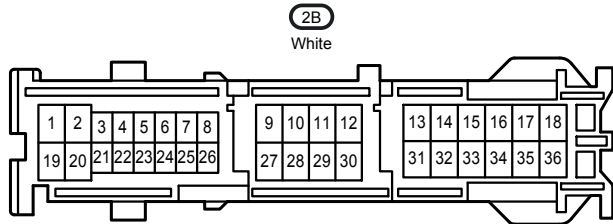
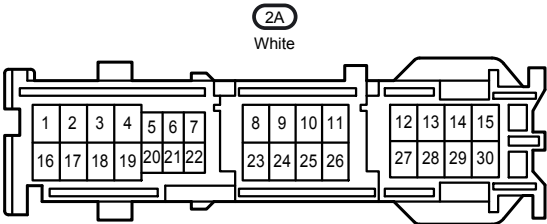
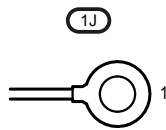
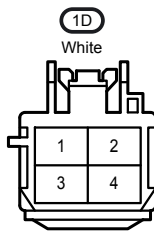
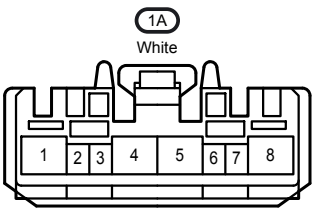
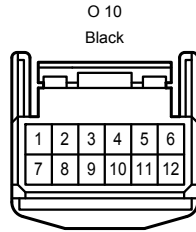
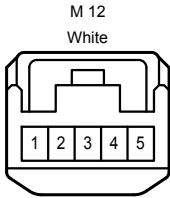
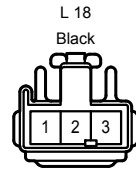
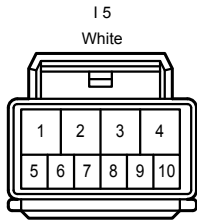
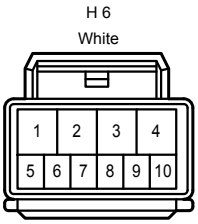

Theft Deterrent <Except TMC Made>

2S

White

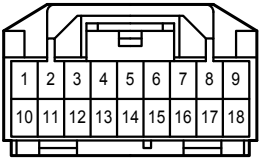

AE10

Gray

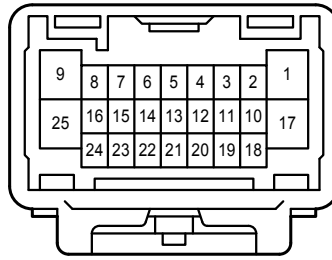
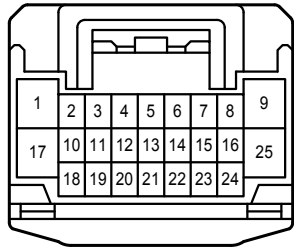

AE11

White

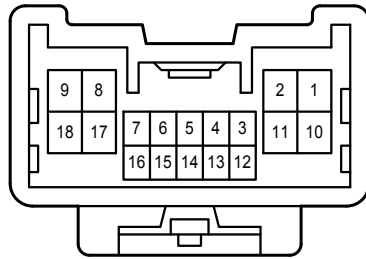
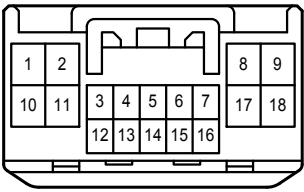

EL1

White

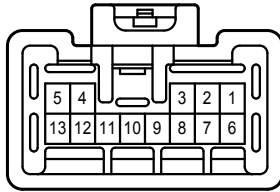
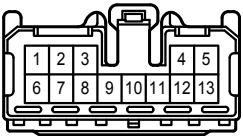

EM1

Gray

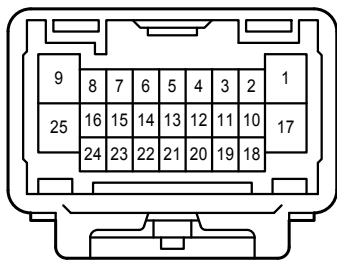
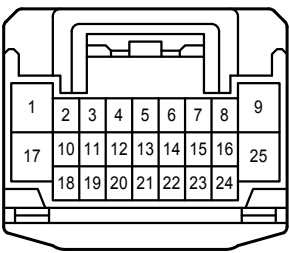

HE4

White

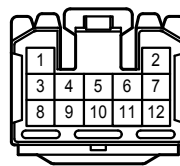

IE2

White

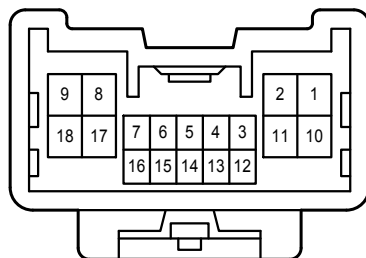
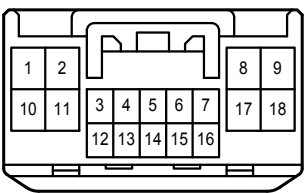

IE4

White

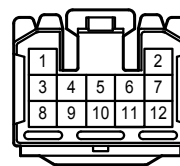

Tire Pressure Warning System <Except TMC Made>

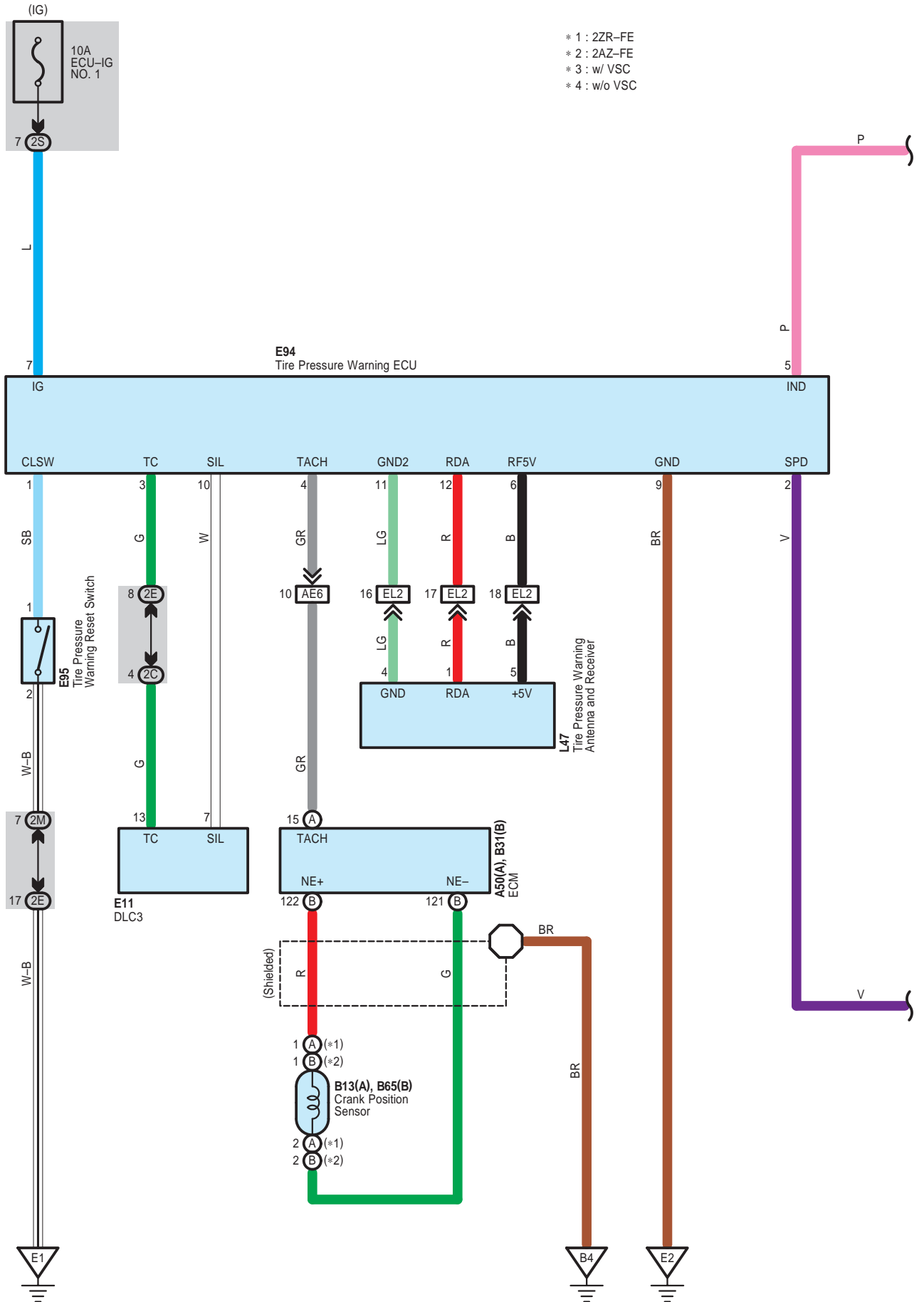

Tire Pressure Warning System <Except TMC Made>

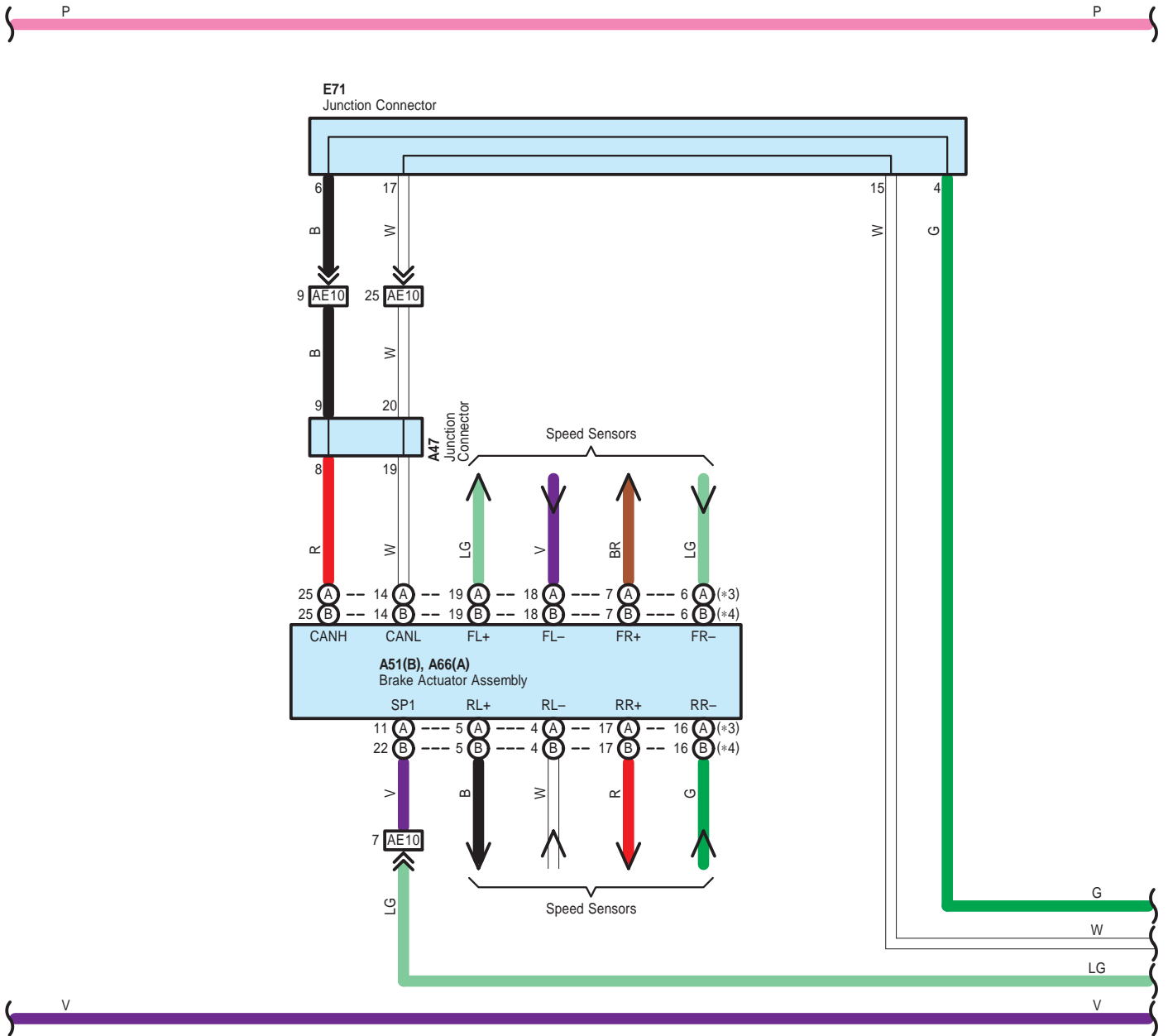



Tire Pressure Warning System <Except TMC Made>

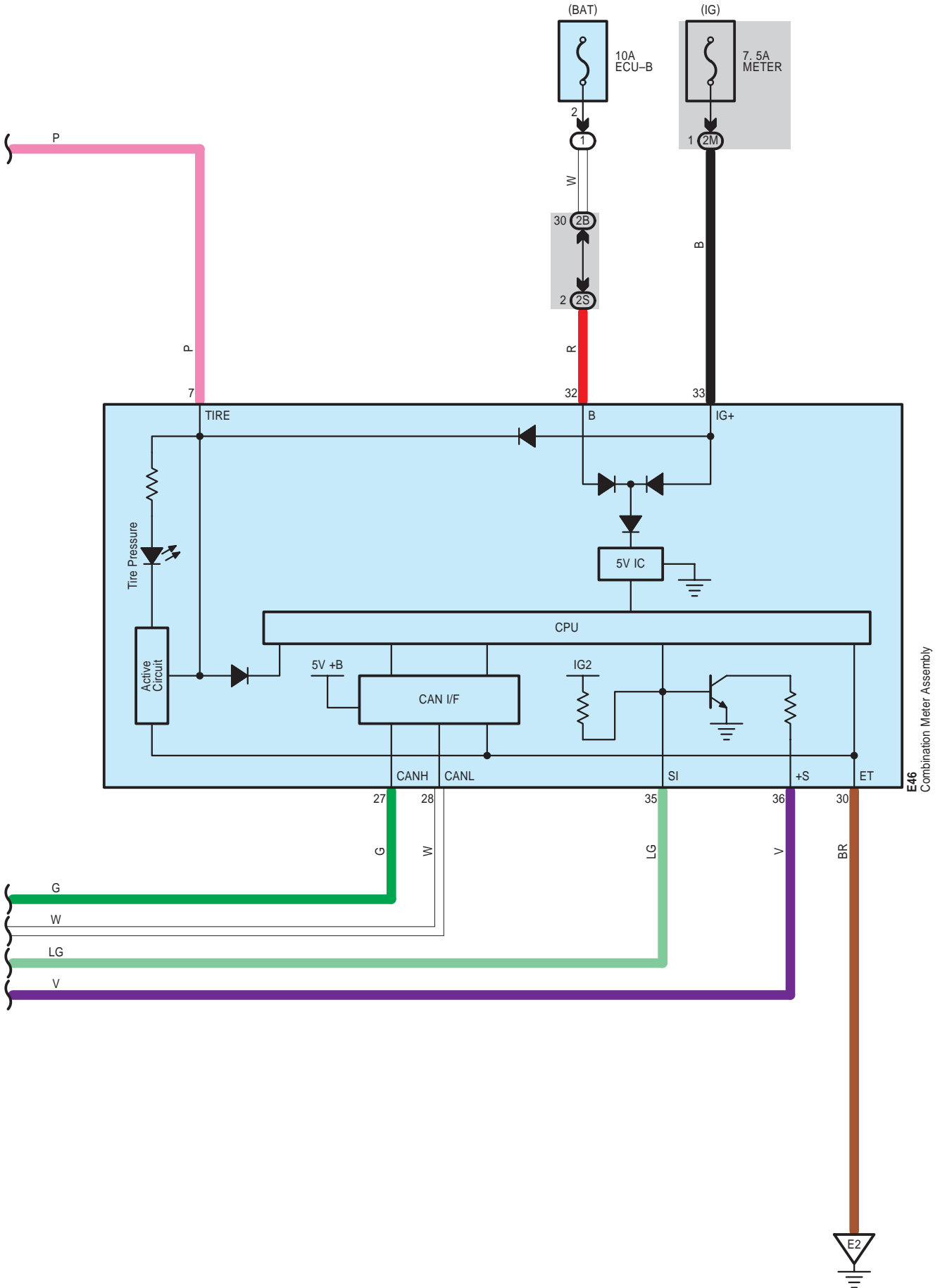

Tire Pressure Warning System <Except TMC Made>

A 47  
White

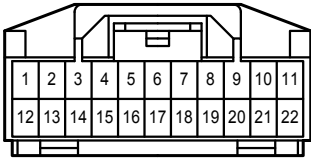

A 50  
Black

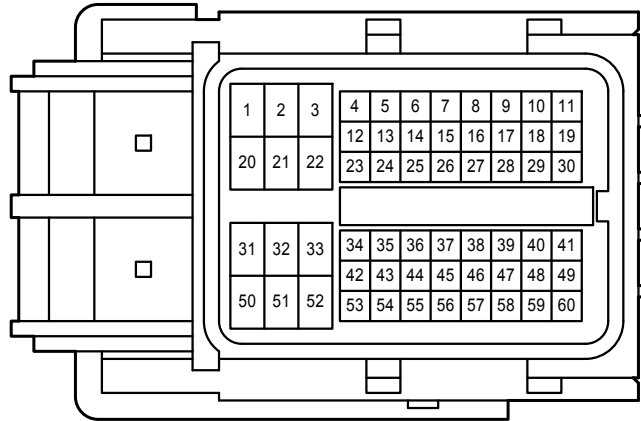

A 51  
Gray

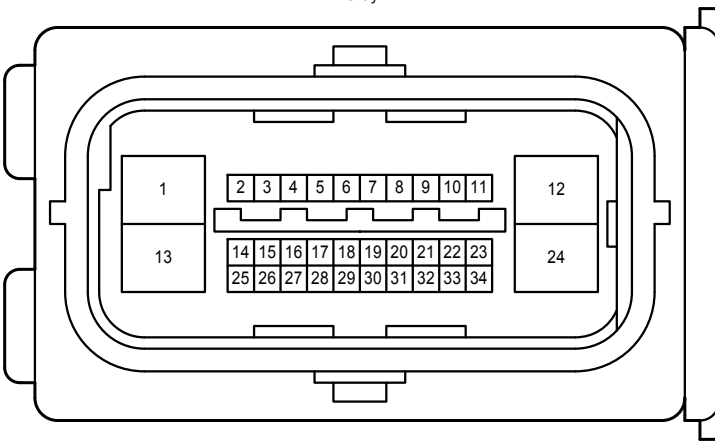

A 66  
Black

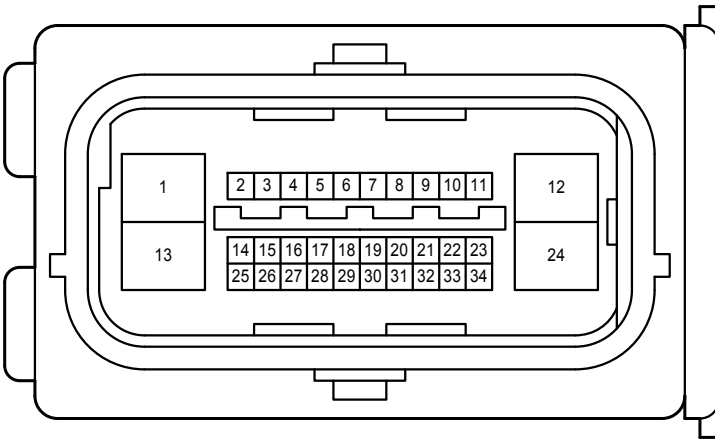

B 13  
Black

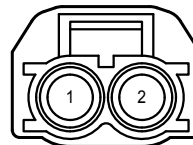

Tire Pressure Warning System <Except TMC Made>

B 31  
Black

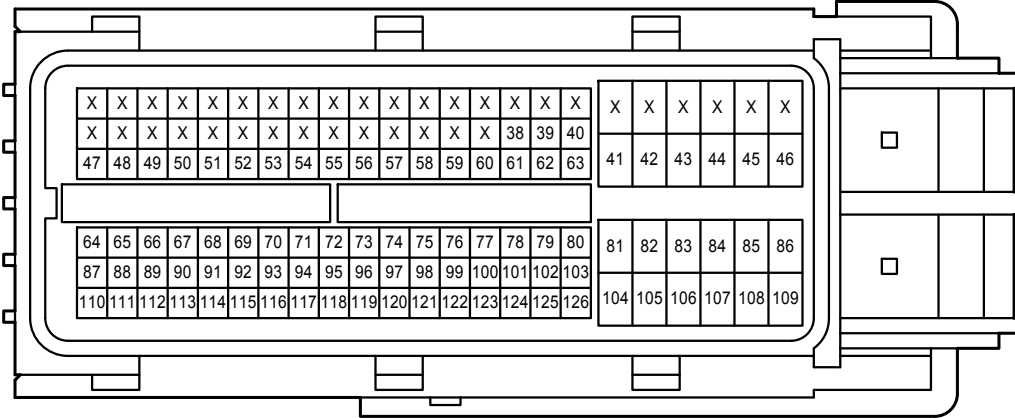

B 65  
Gray



E 11  
White

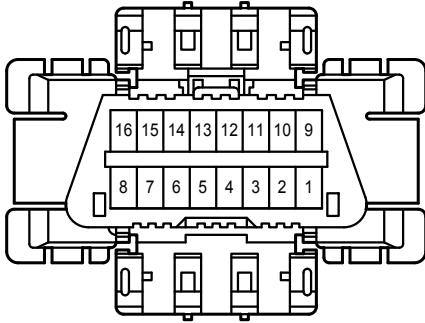

E 46  
White

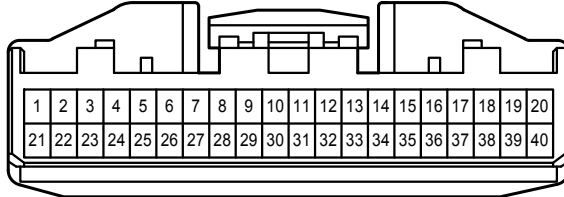

E 71  
White

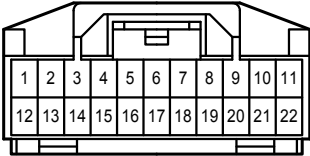

E 94  
Black

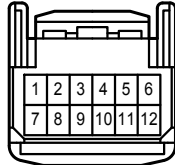

E 95  
Black

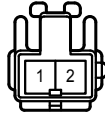

L 47  
White

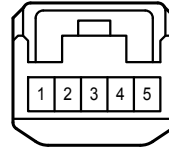

2B  
White

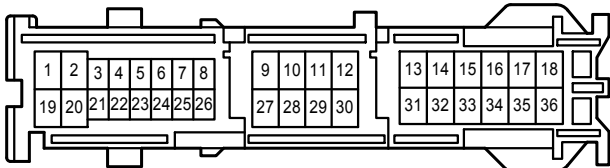

2C  
White

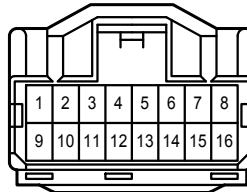

2E  
White

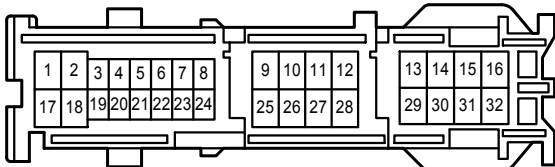

2M  
White

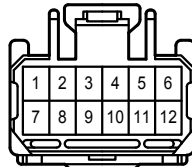

2S  
White

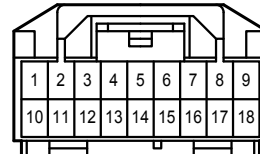

Tire Pressure Warning System <Except TMC Made>

AE6  
Gray

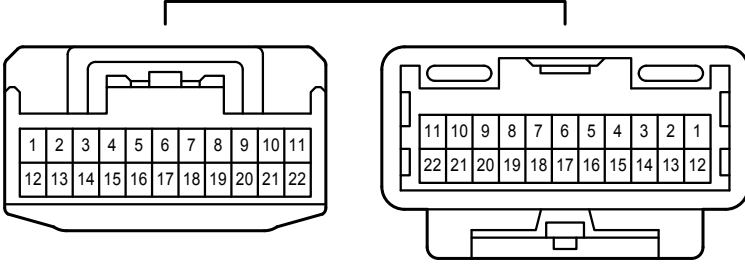

AE10  
Gray

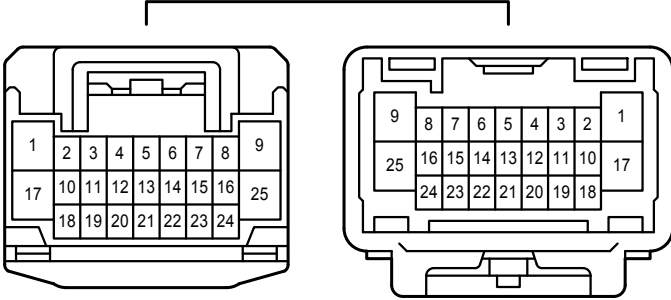

EL2  
White

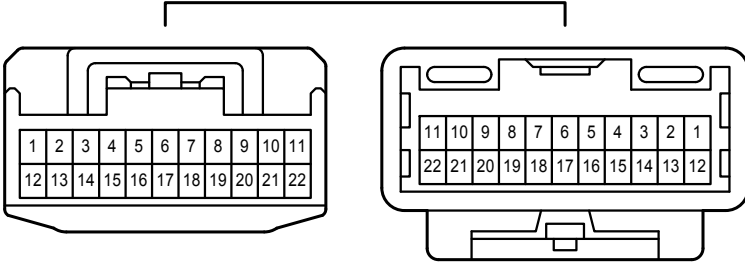

Tire Pressure Warning System <TMC Made>

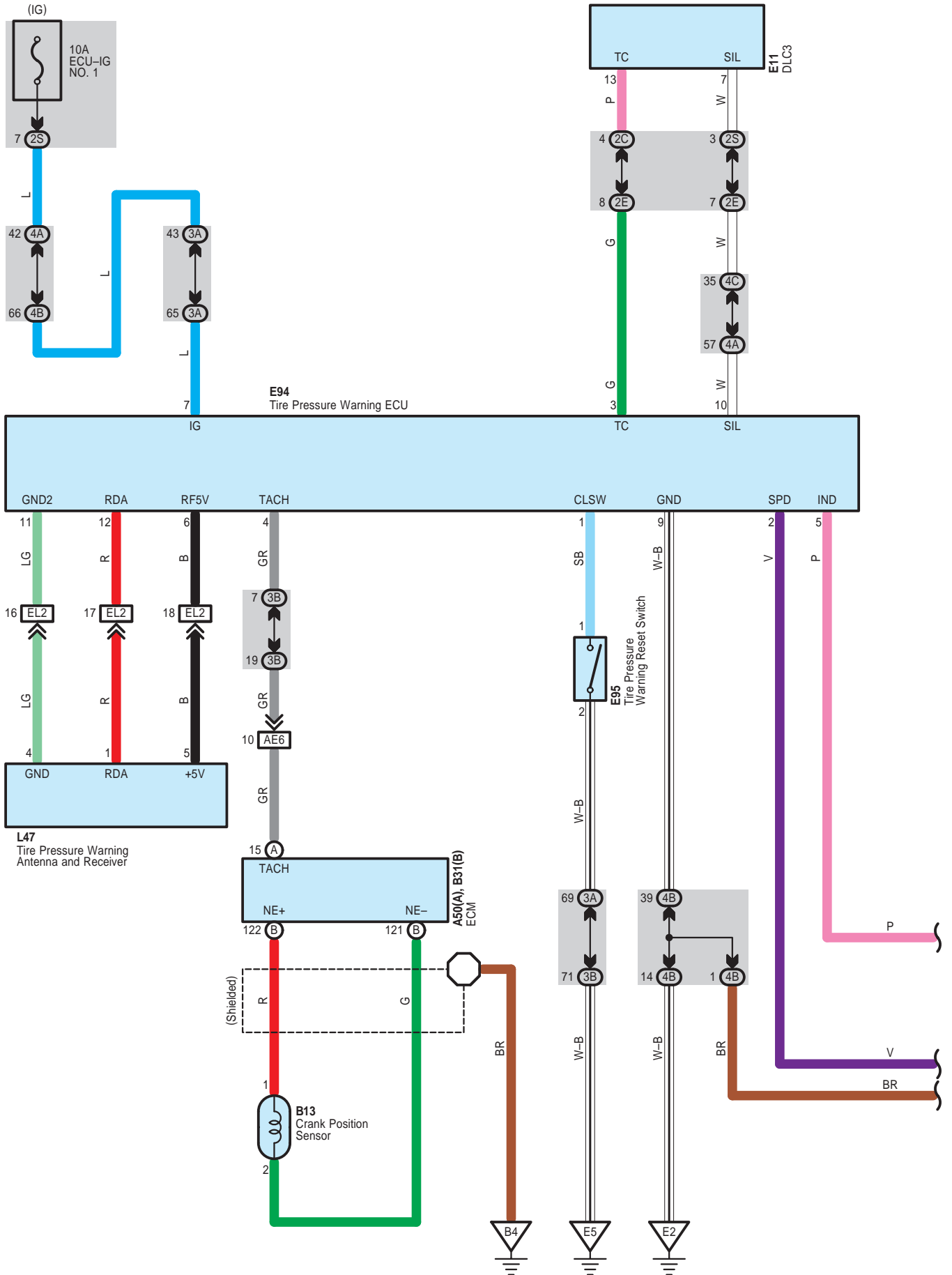

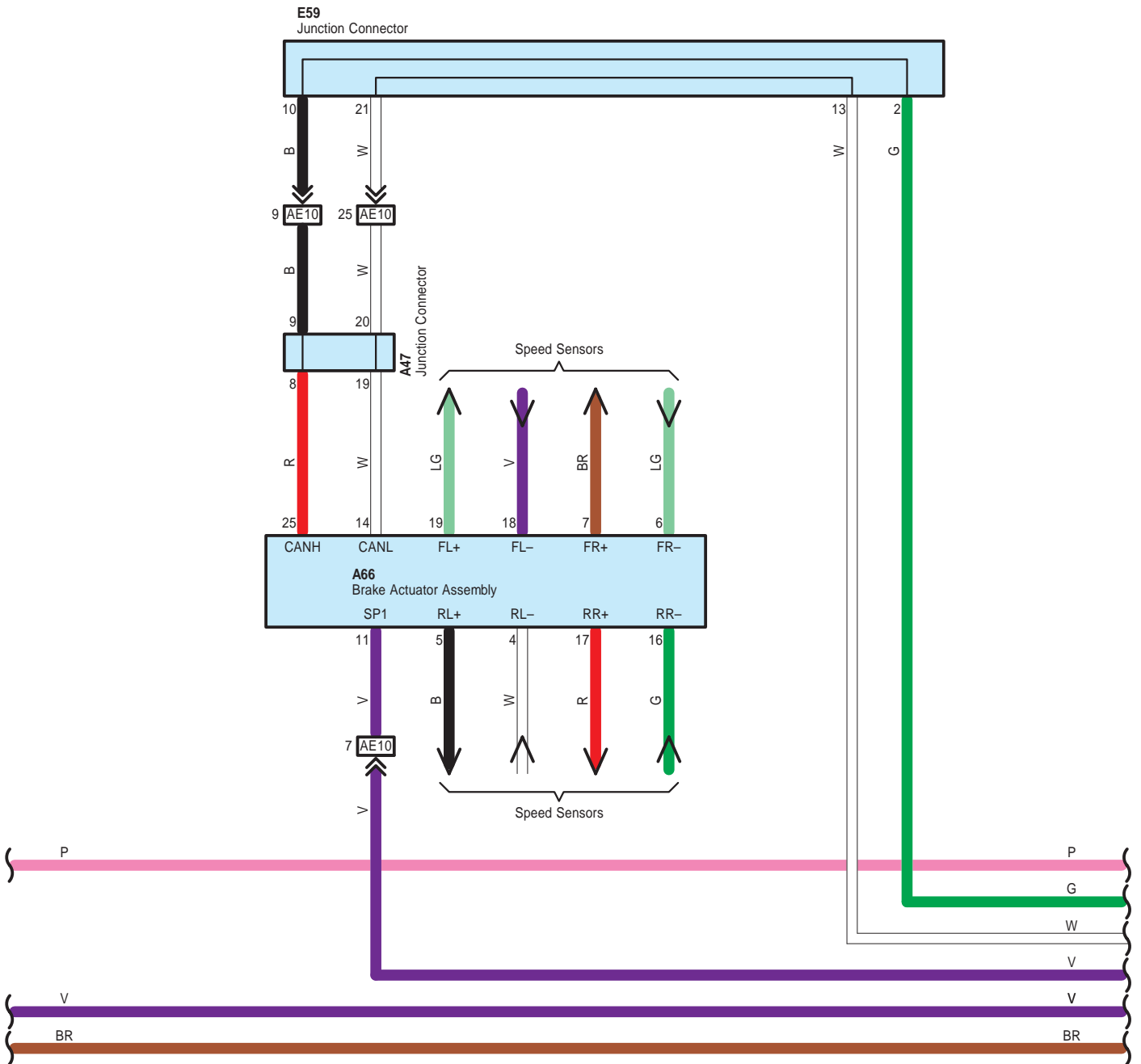

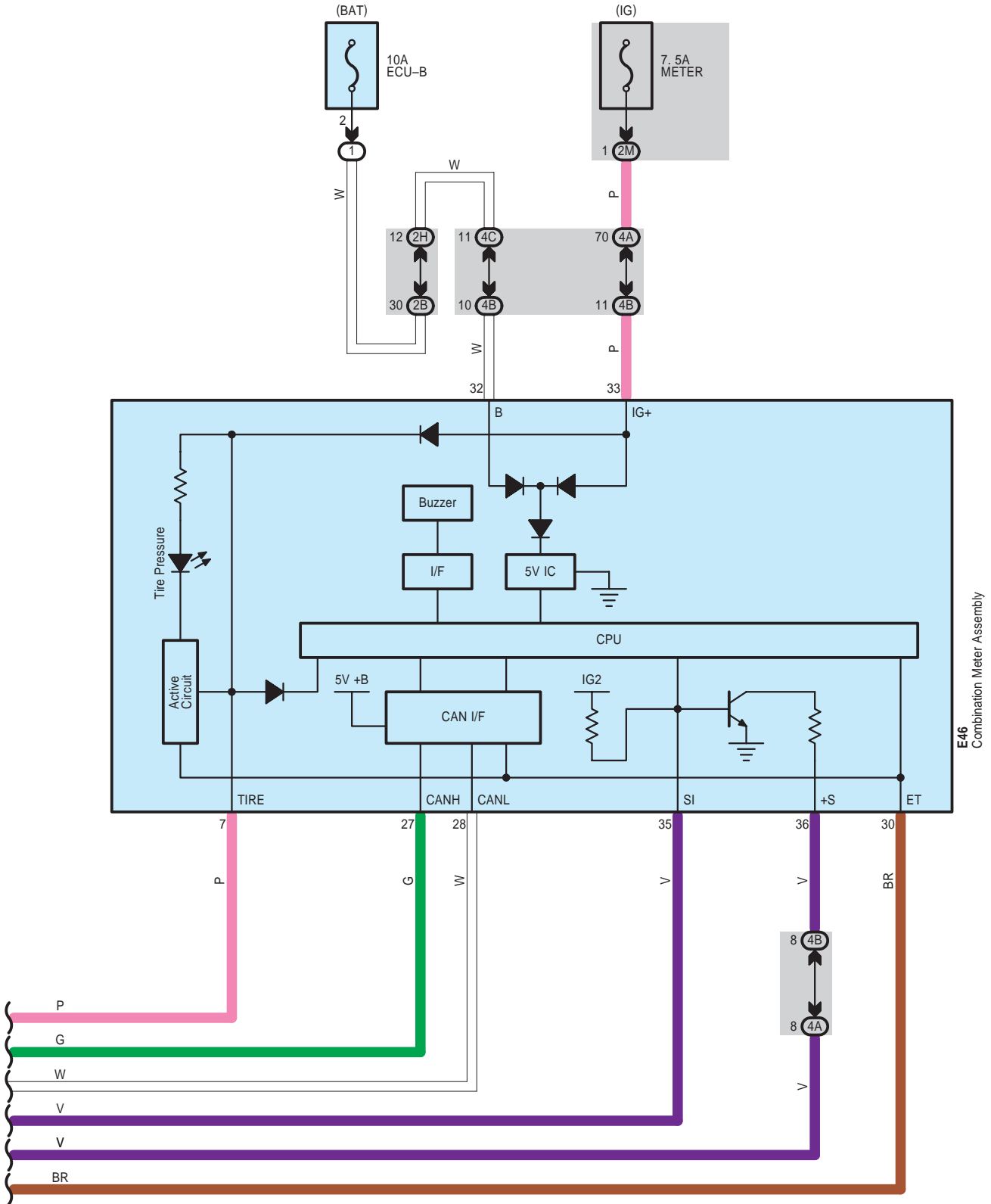





Tire Pressure Warning System <TMC Made>

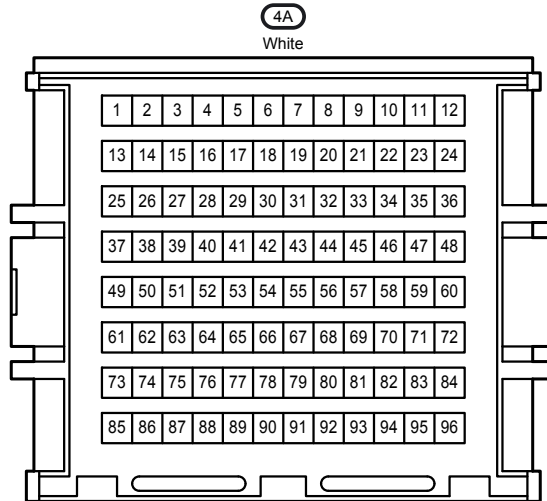
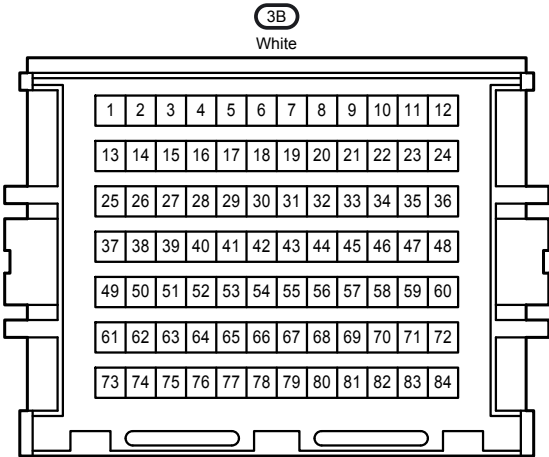
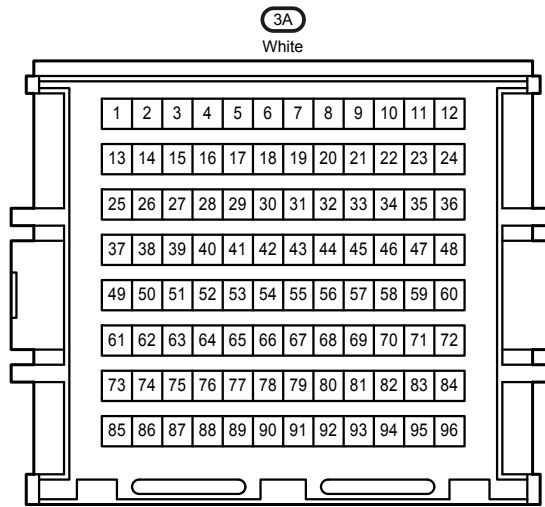
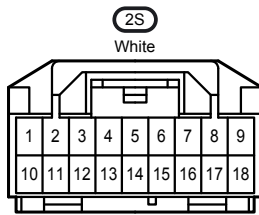
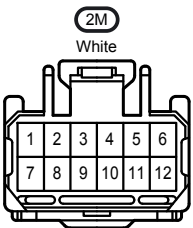
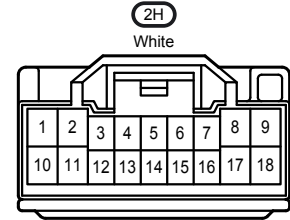
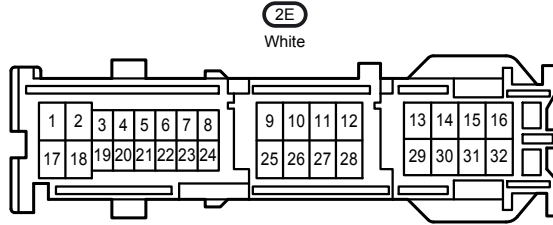
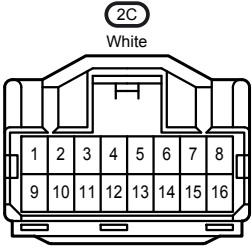
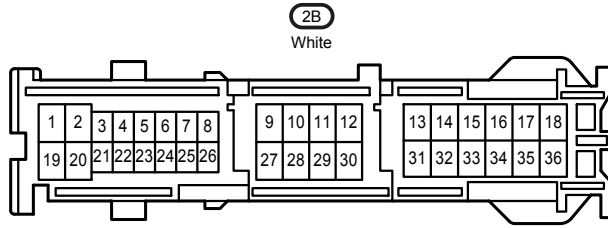
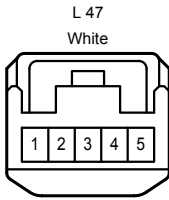
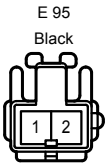

Tire Pressure Warning System <TMC Made>

4B  
White

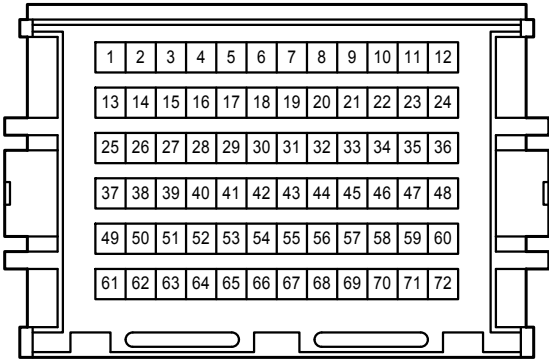

4C  
White

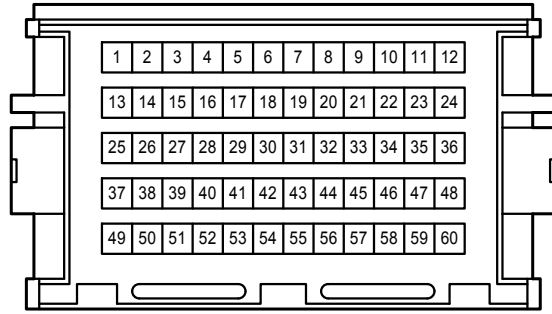

AE6  
Gray

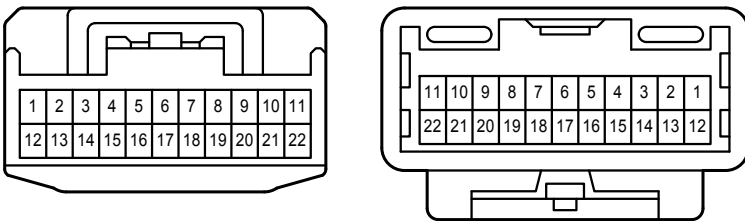

AE10  
Gray

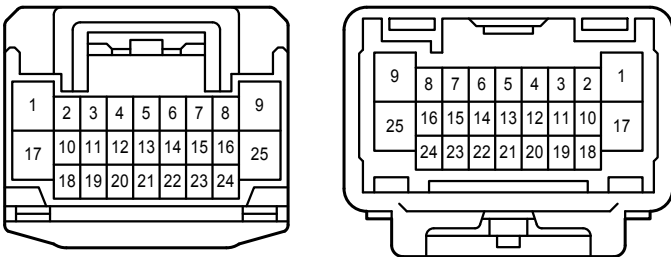

EL2  
White

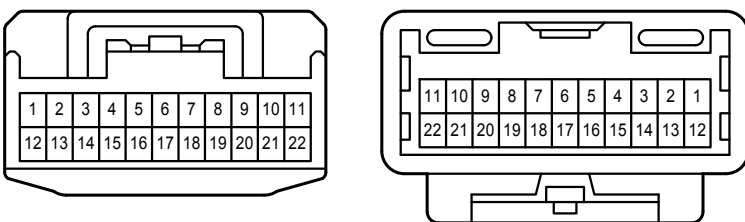

Turn Signal and Hazard Warning Light <Except TMC Made>

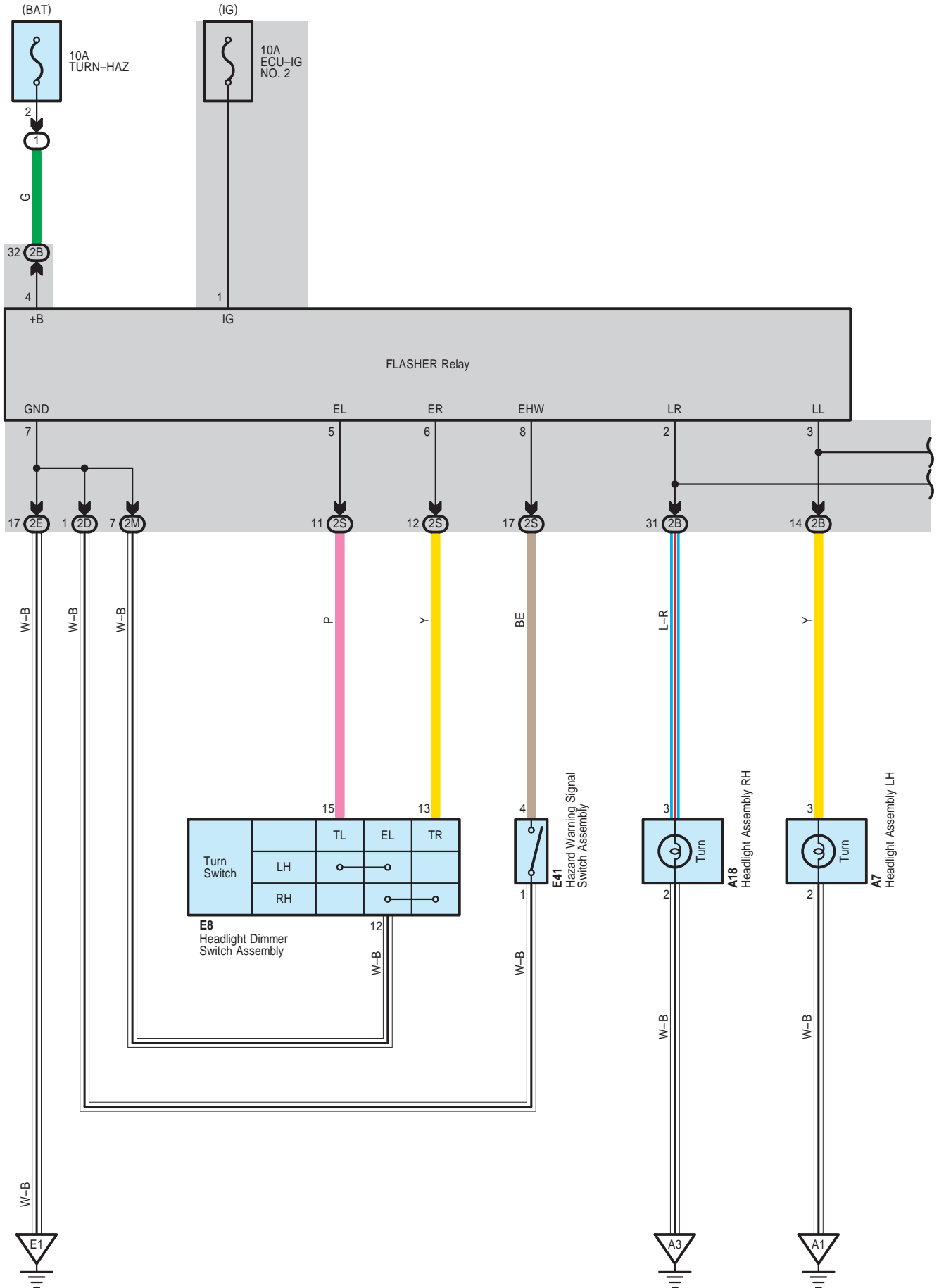

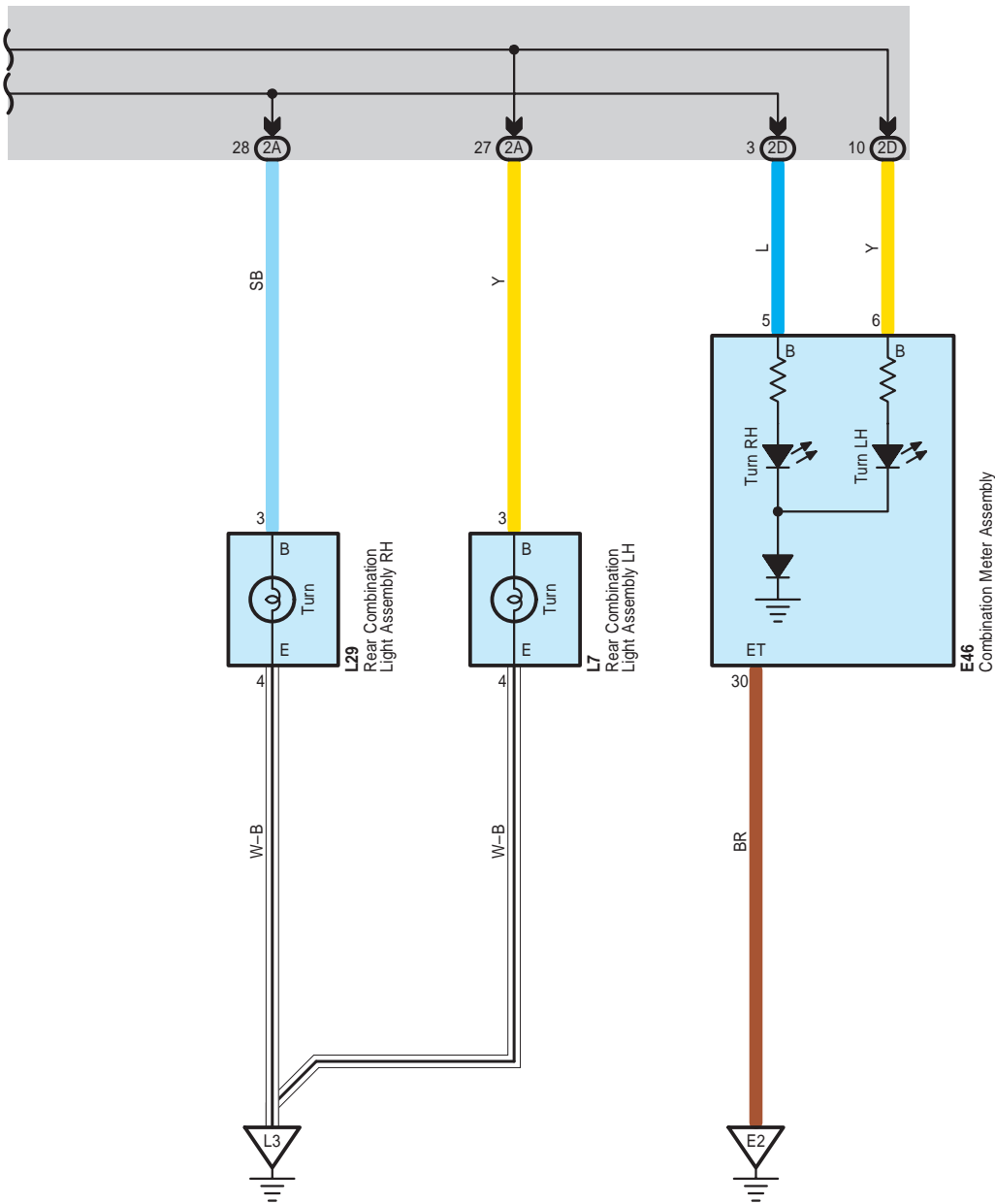

Turn Signal and Hazard Warning Light <Except TMC Made>

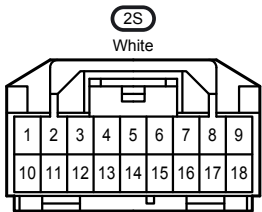
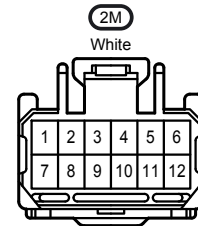
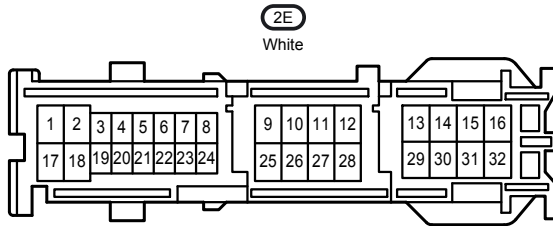
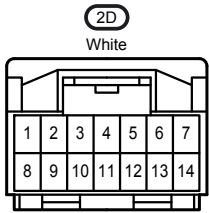
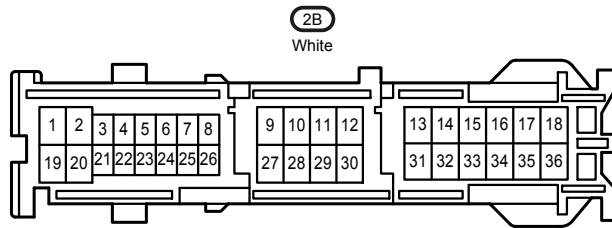
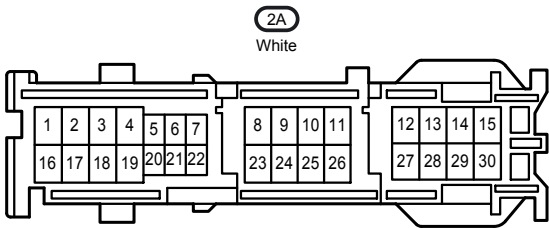
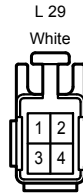
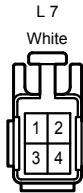
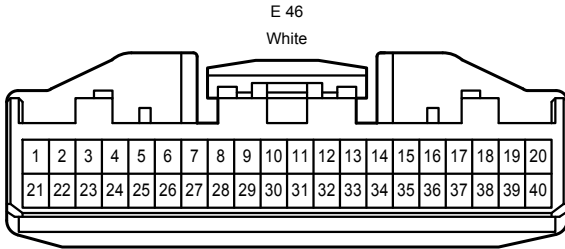
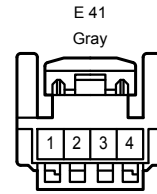
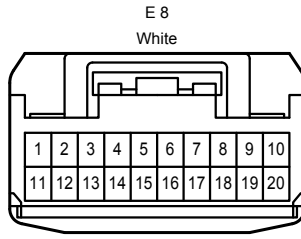
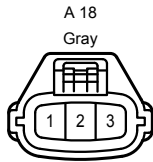
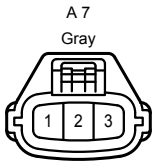

Turn Signal and Hazard Warning Light <TMC Made>

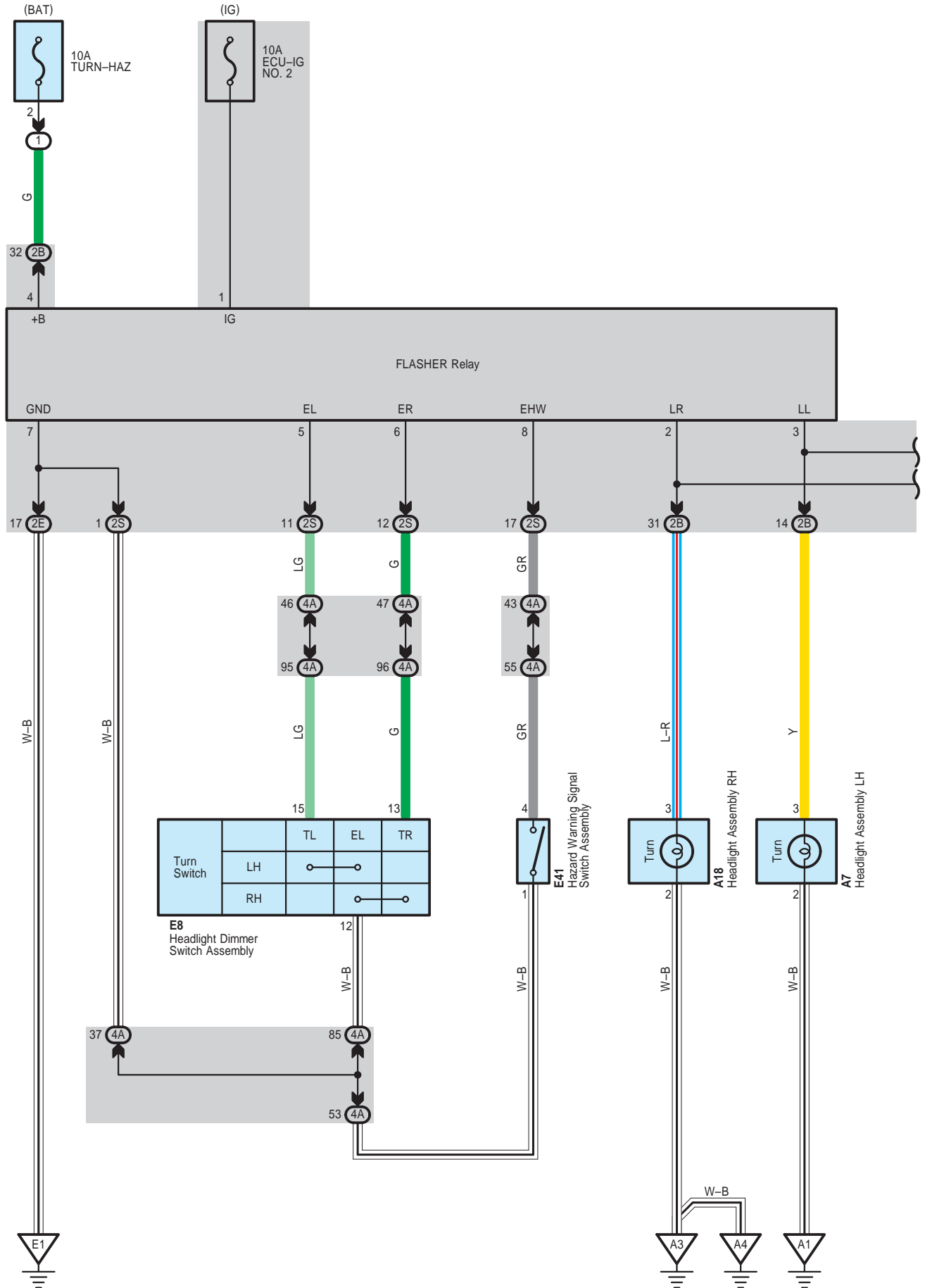

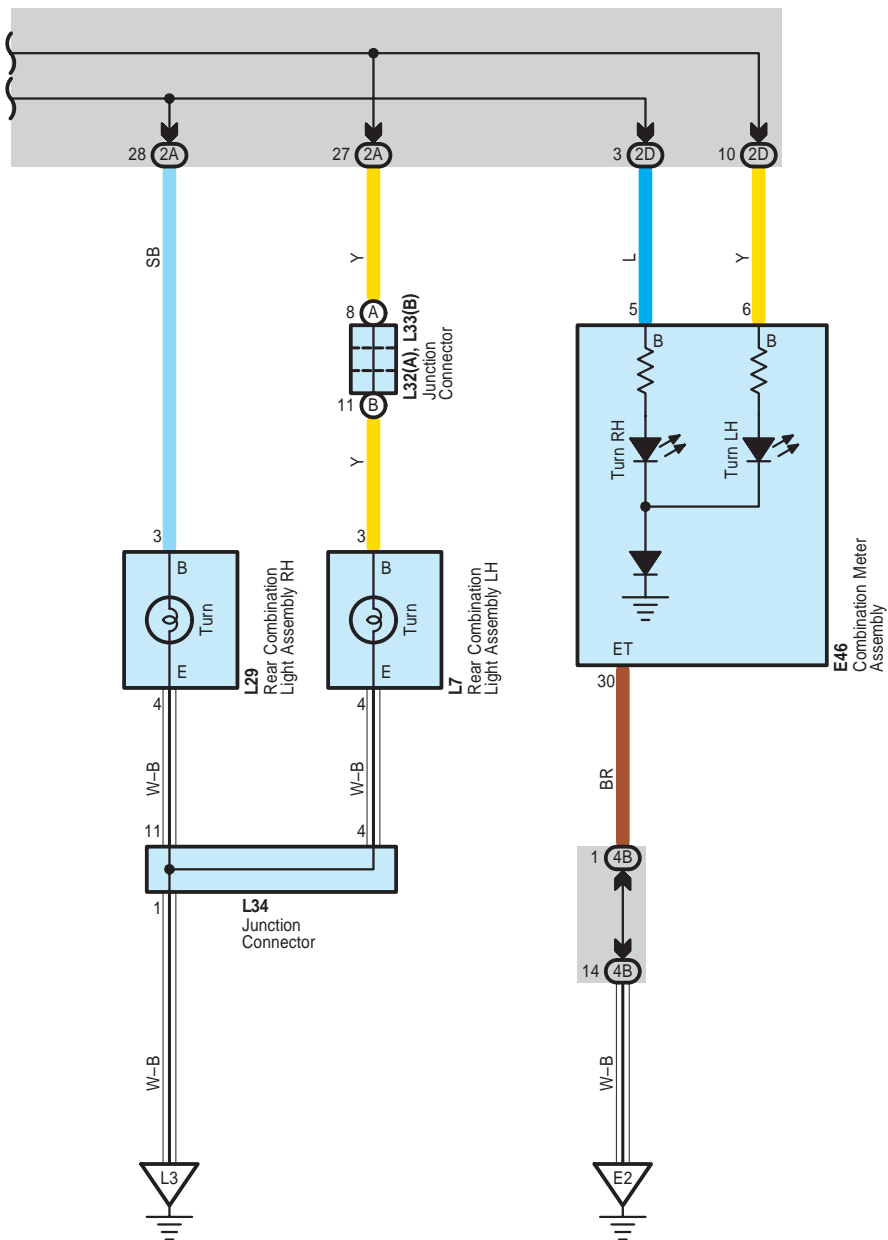

Turn Signal and Hazard Warning Light <TMC Made>

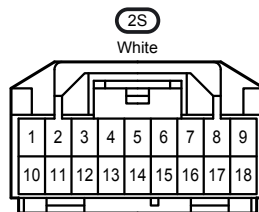
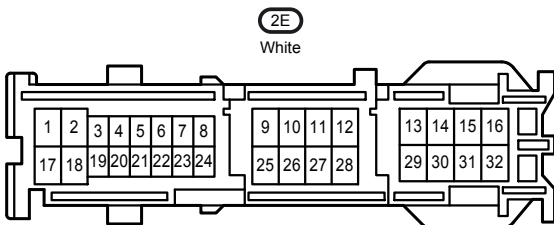
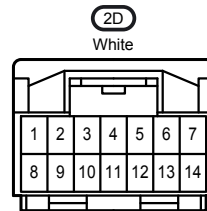
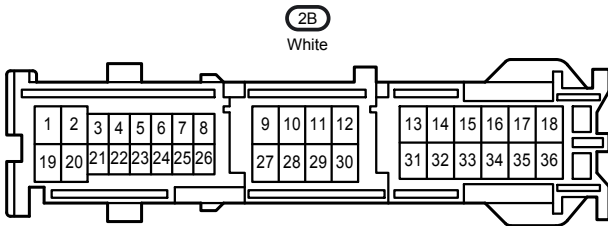
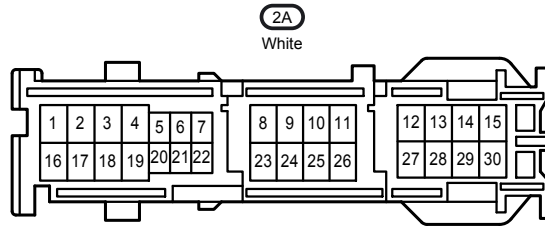
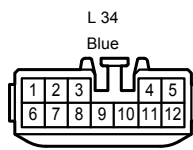
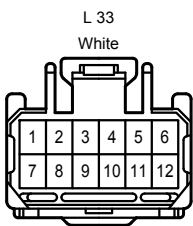
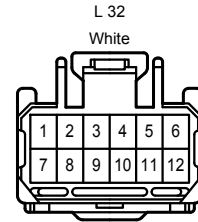
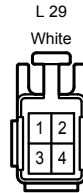
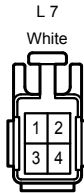
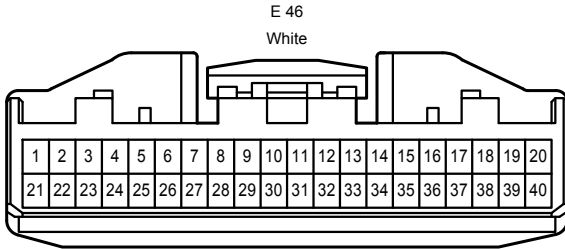
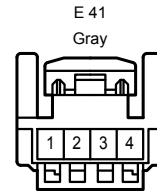
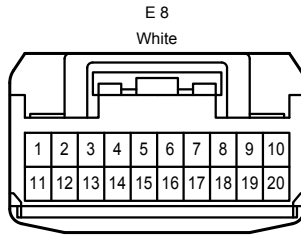
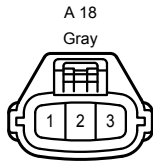
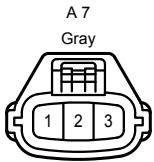



Turn Signal and Hazard Warning Light <TMC Made>

4A  
White

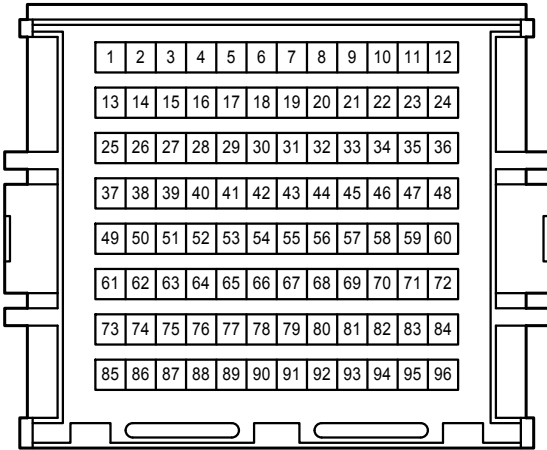

4B  
White

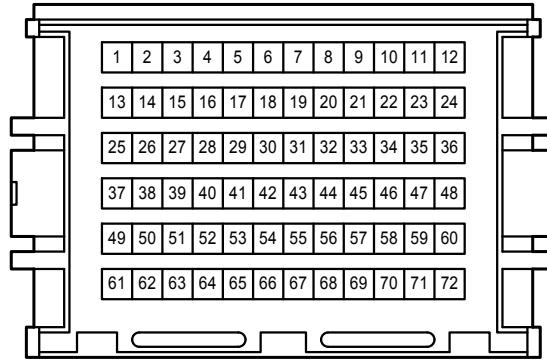

Wireless Door Lock Control <w/o Smart Key System , TMC Made>

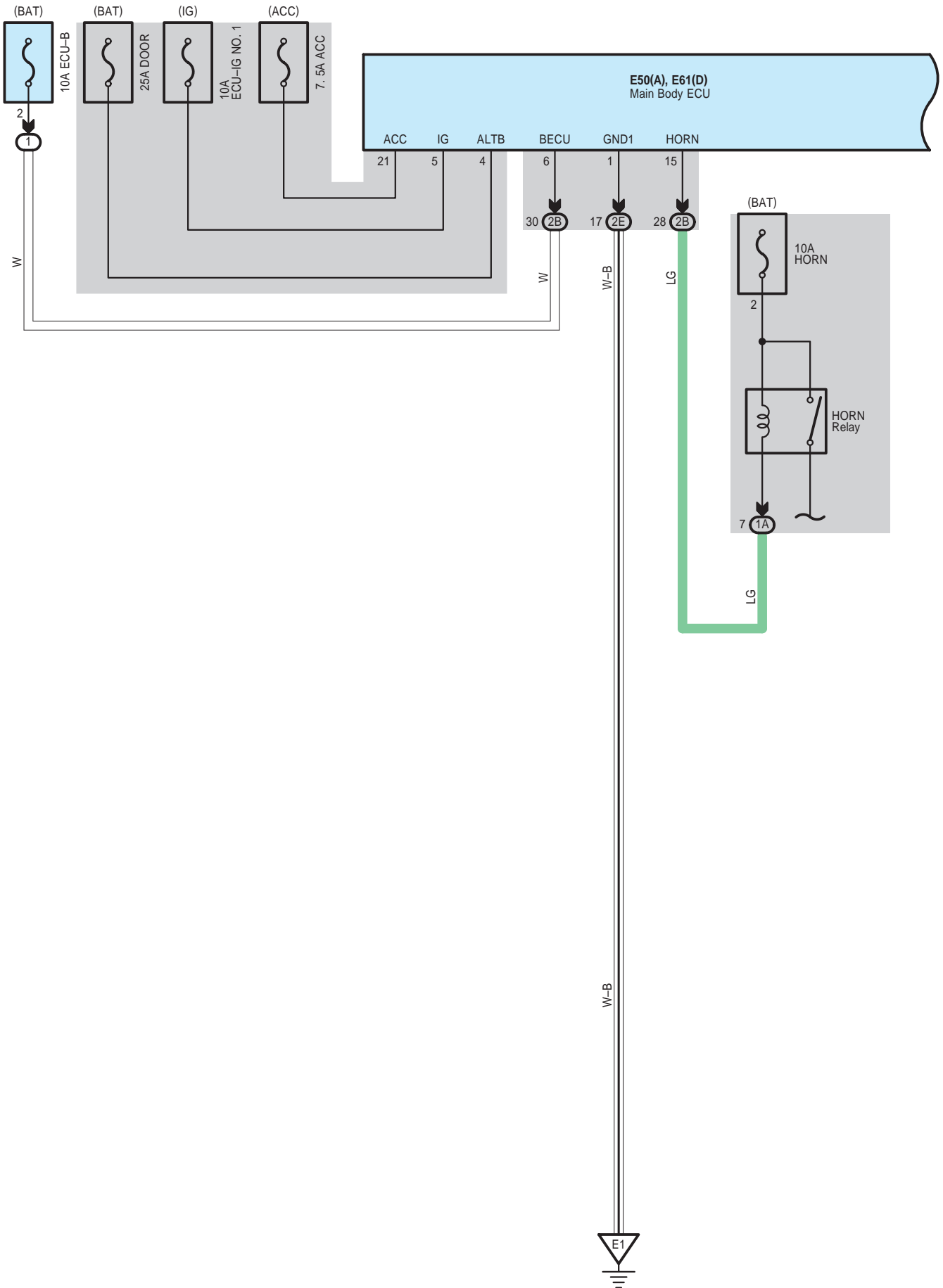

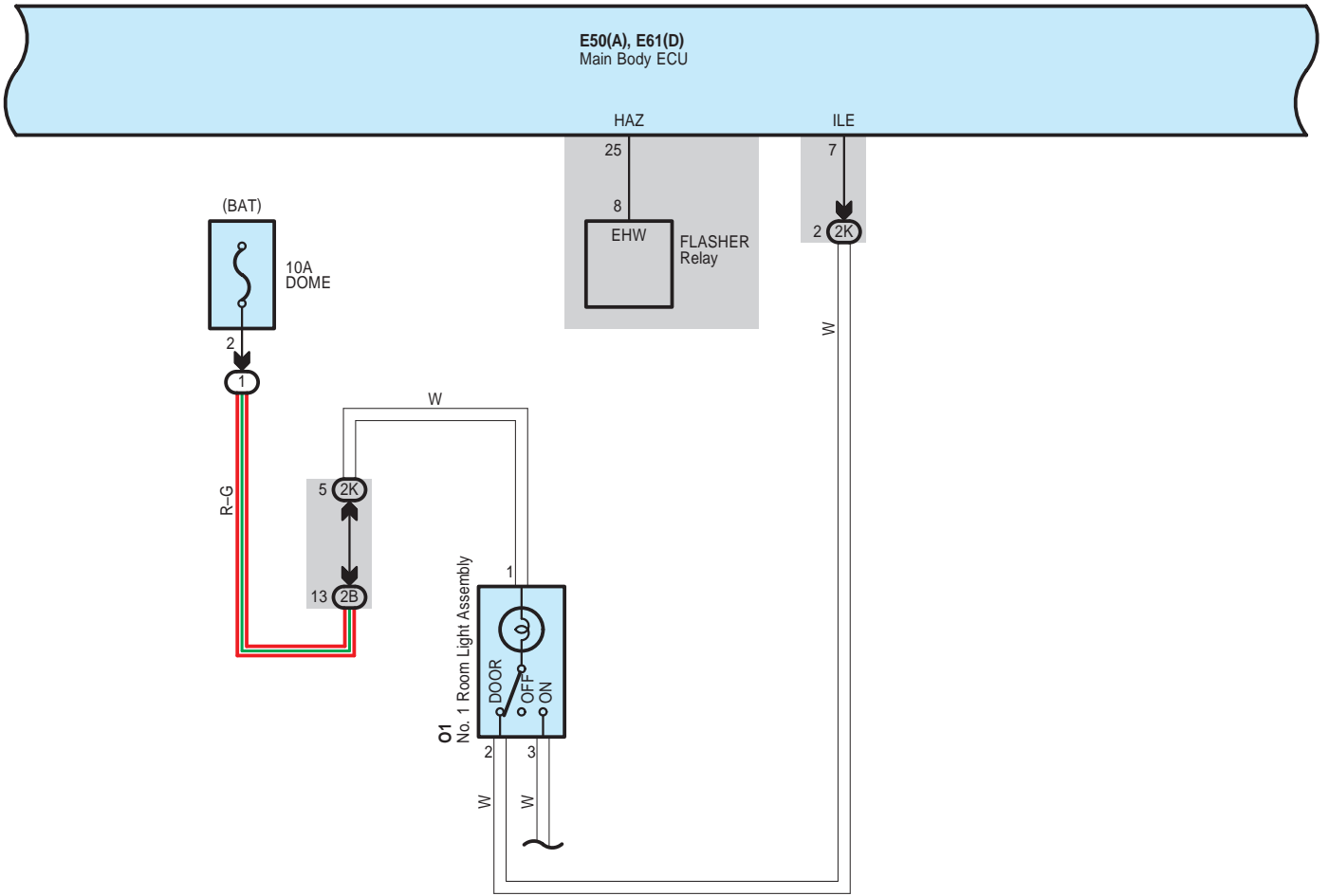

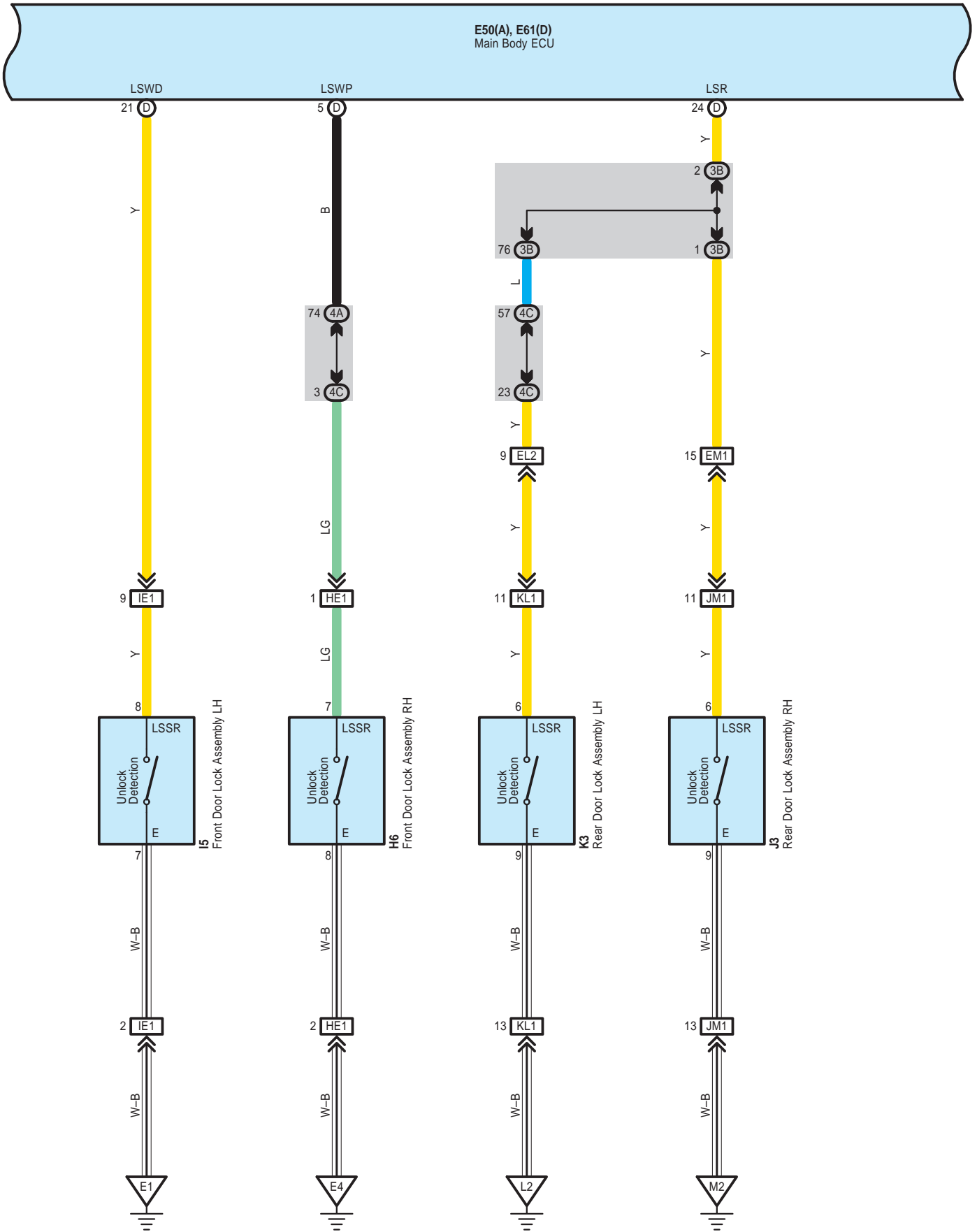

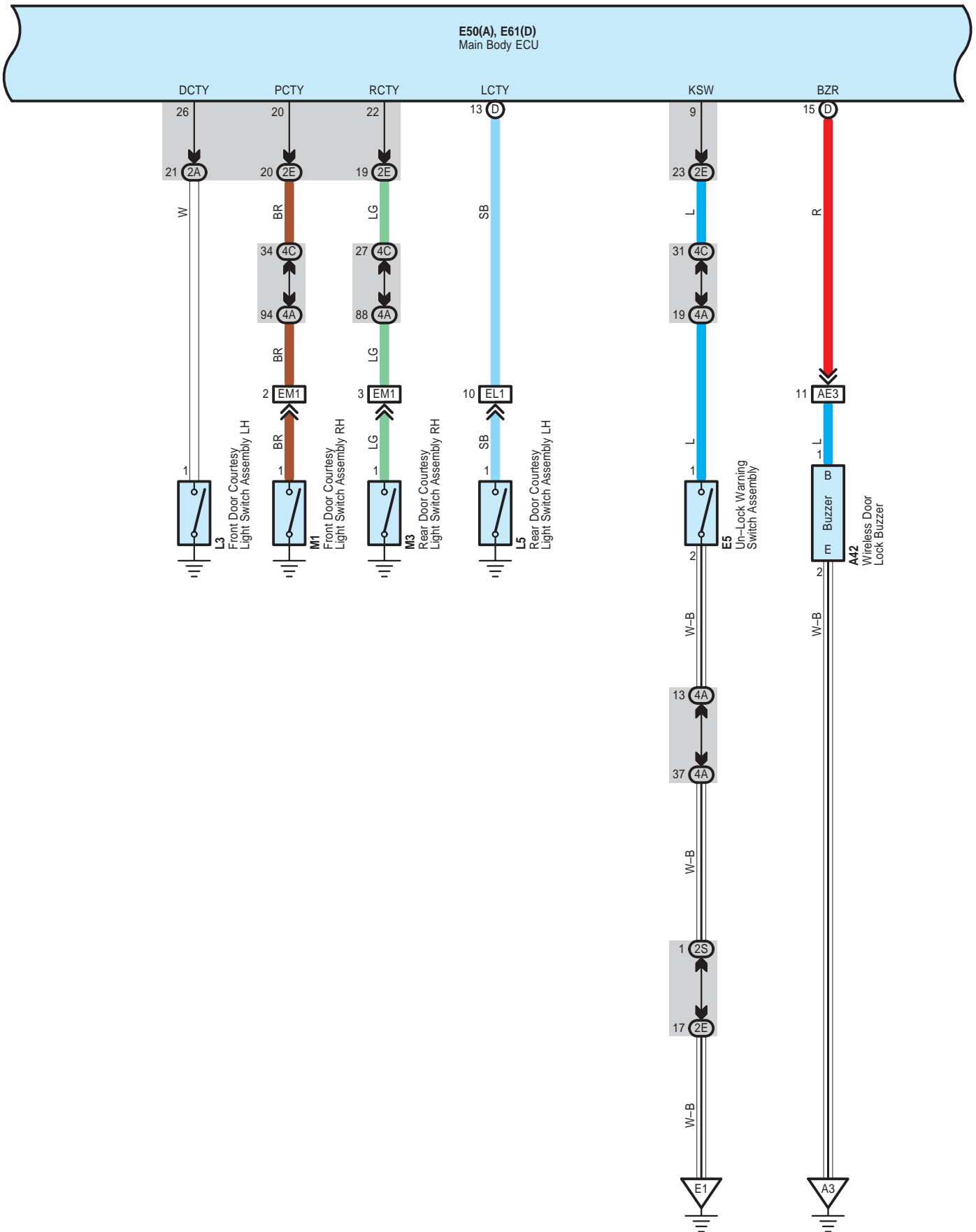

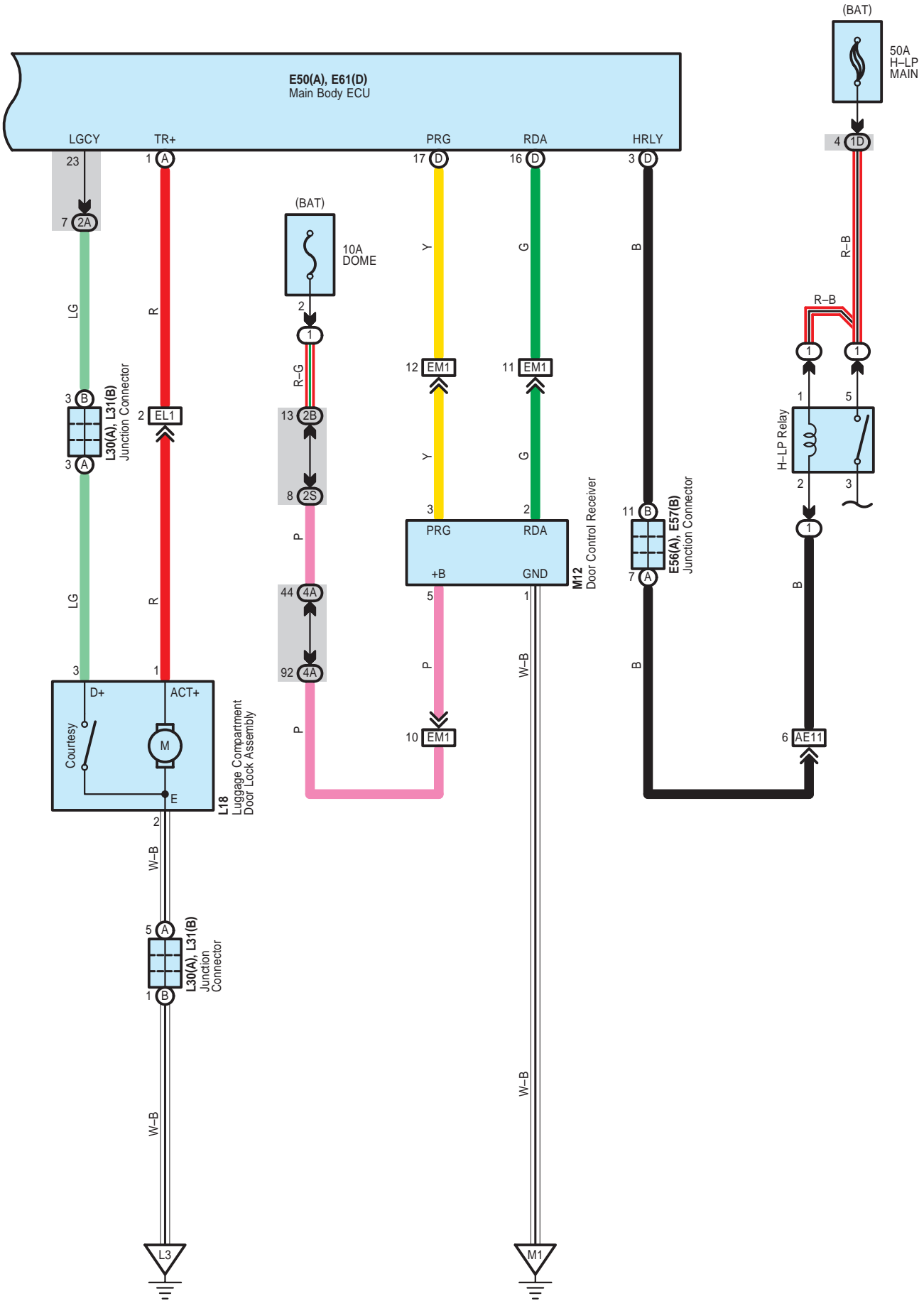

Wireless Door Lock Control <w/o Smart Key System , TMC Made>

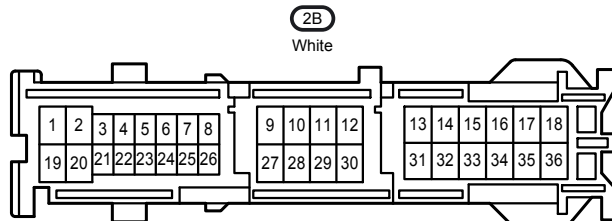
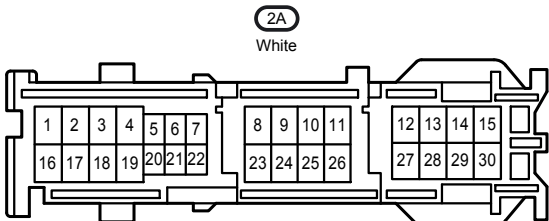
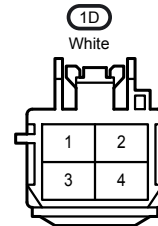
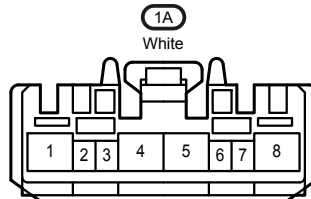
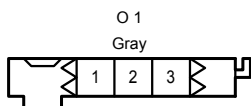
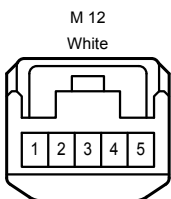
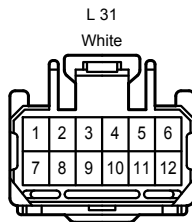
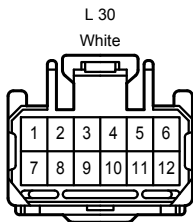
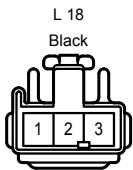
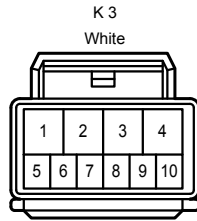
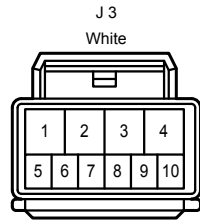
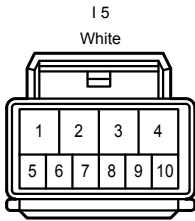
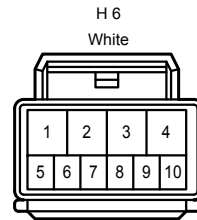
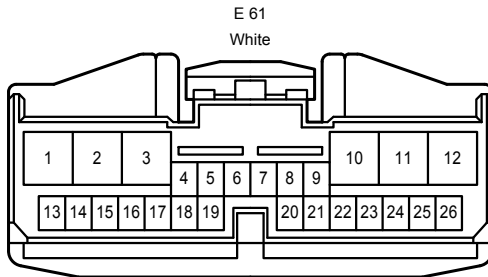
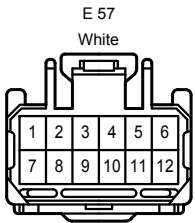
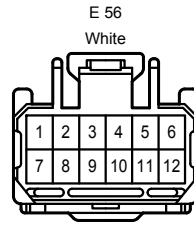
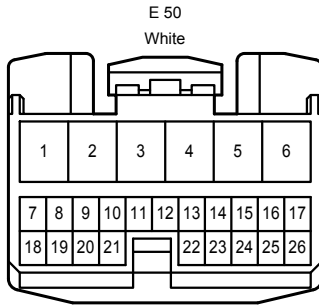
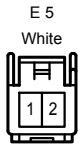
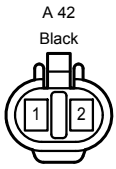

Wireless Door Lock Control <w/o Smart Key System , TMC Made>

2E  
White

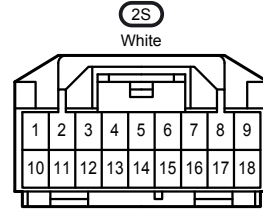
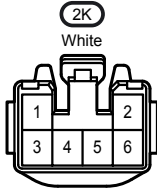
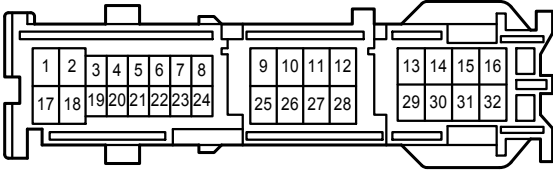

3B  
White

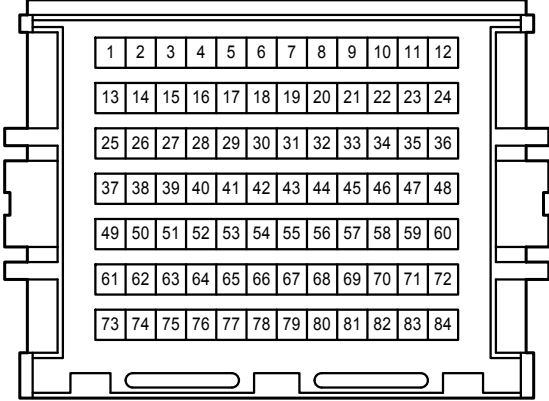

4A  
White

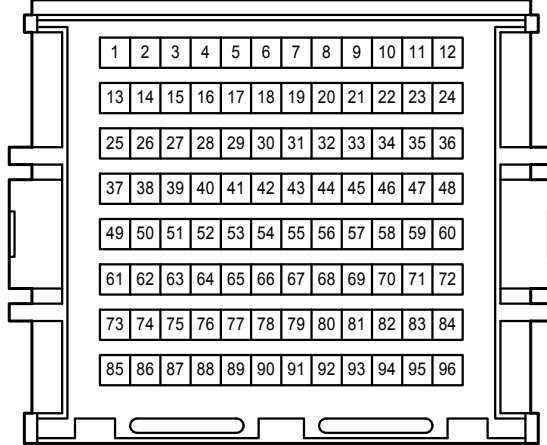

4C  
White

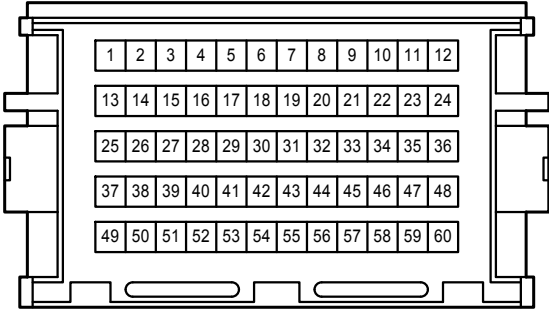

AE3  
White

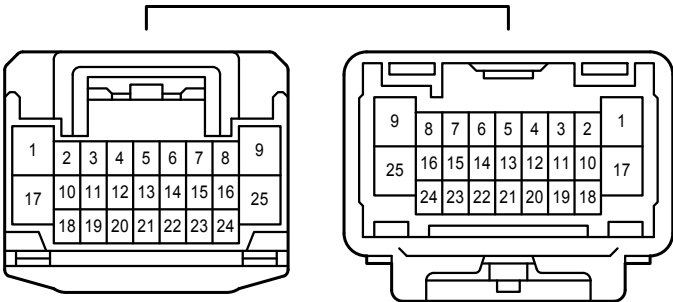



AE11  
White

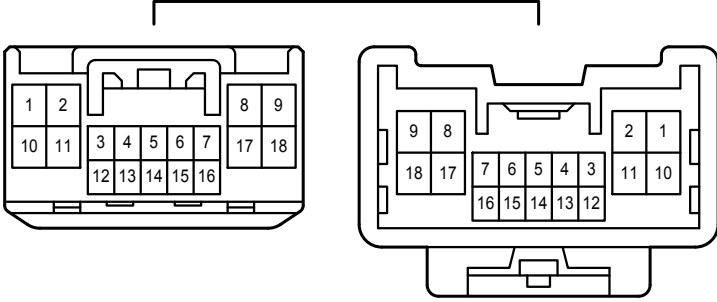

EL1  
White

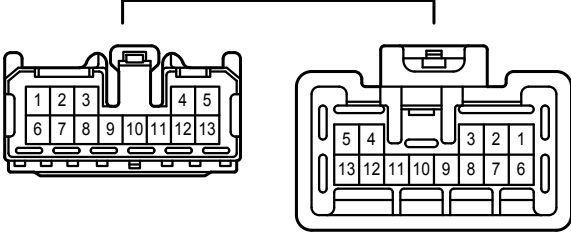

EL2  
White

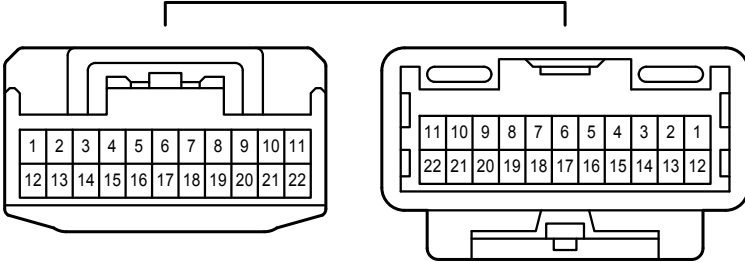

EM1  
Gray

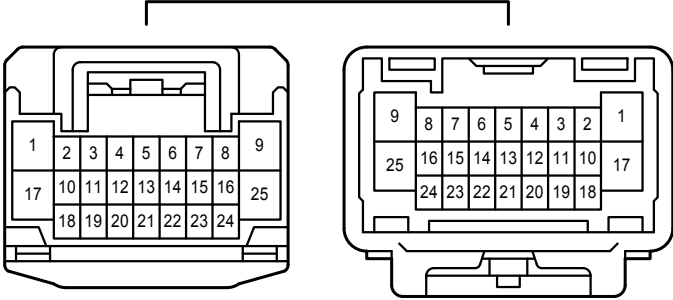

HE1  
Blue

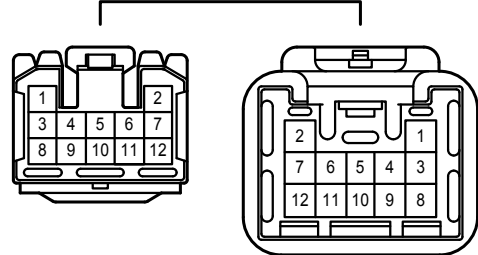

IE1  
Blue

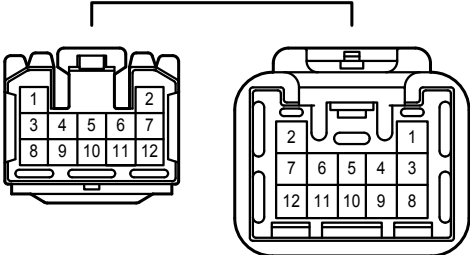

Wireless Door Lock Control <w/o Smart Key System , TMC Made>

JM1  
White

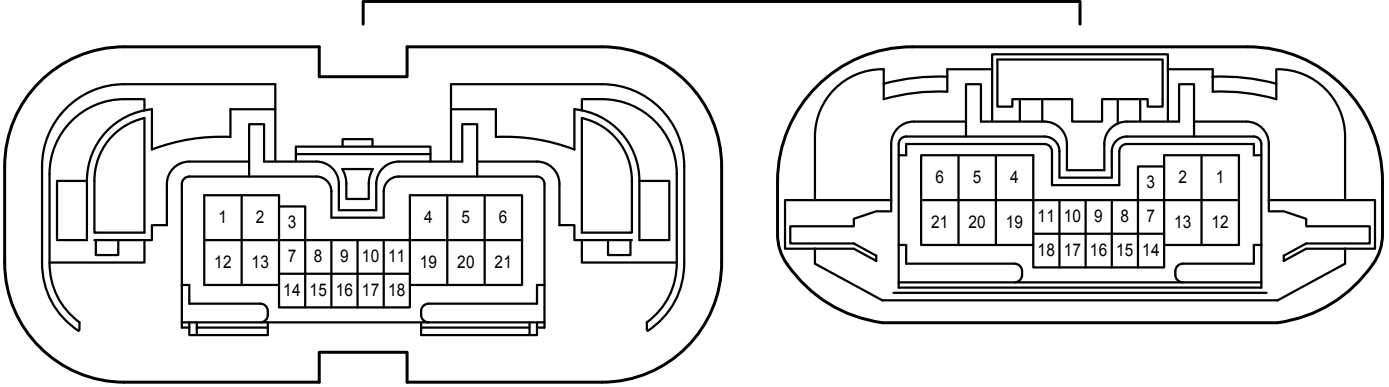

KL1  
White

